

**For professional industrial electronics equipment**

**Construction**

- Charge-discharge proof, polar
- Aluminum case with insulating sleeve
- Negative pole connected to case
- Axial leads, welded to ensure perfect electrical contact

**Features**

- High reliability and long useful life
- Can be operated at temperatures of up to 105 °C<sup>1)</sup>
- High parametric stability
- High ripple current capability

**Applications**

- Professional industrial electronics equipment
- For filtering, coupling and pulse circuits
- Automotive electronics
- 450-V versions for electronic ballasts available upon request

**Tape packaging**

Capacitors with  $d \leq 16$  mm are also available on tape.  
Refer to [page 305](#) for information on tapes and examples on how to order them.

**Specifications and characteristics in brief**

	B 41 588		B 43 588	
Rated voltage $U_R$	10 to 100 V–		160 to 350 V–	
Surge voltage $U_S$	$1,15 \cdot U_R$		$1,15 \cdot U_R$ (for $U_R \leq 250$ V–) $1,10 \cdot U_R$ (for $U_R = 350$ V–)	
Rated capacitance $C_R$	4,7 to 4 700 $\mu$ F		1 to 220 $\mu$ F	
Capacitance tolerance	– 10/+ 50 % $\triangleq$ T		– 10/+ 50 % $\triangleq$ T	
Useful life	$d \leq 8,5$ mm	$d \geq 10$ mm	$d \leq 8,5$ mm	$d \geq 10$ mm
	$> 200\,000$ h ( $1,3 \cdot I_{-R,85^\circ\text{C}}$ )	$> 200\,000$ h ( $2,0 \cdot I_{-R,85^\circ\text{C}}$ )	$> 200\,000$ h ( $1,3 \cdot I_{-R,85^\circ\text{C}}$ )	$> 200\,000$ h ( $1,7 \cdot I_{-R,85^\circ\text{C}}$ )
85 °C, $U_R$ , $I_{-max}$	$> 6\,000$ h	$> 10\,000$ h	$> 6\,000$ h	$> 8\,000$ h
Failure percentage	$\leq 0,5$ % (during useful life)		$\leq 0,5$ % (during useful life)	
Failure rate (1 fit = $1 \cdot 10^{-9}$ /h)	$d \leq 8,5$ mm: $\leq 50$ fit $d \geq 10$ mm: $\leq 20$ fit		$d \leq 8,5$ mm: $\leq 50$ fit $d \geq 10$ mm: $\leq 20$ fit	

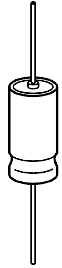

KAL0277–Z

1) Operation at 105 °C and 0,6  $I_{-max,85^\circ\text{C}}$  permissible for a total of 500 h.



**B 41 588**  
**B 43 588**

### Specifications and characteristics in brief

	B 41 588	B 43 588
Voltage endurance test	5 000 h, 85 °C (at $U_R$ )	
Leakage current $I_{lka}$ (5 min, 20 °C)	$C_R \cdot U_R \leq 1\,000\ \mu\text{C}$ : $I_{lka} \leq 0,01\ \mu\text{A} \cdot \left( \frac{C_R}{\mu\text{F}} \cdot \frac{U_R}{\text{V}} \right)$ or 1 $\mu\text{A}$ (the larger value applies)  $1\,000\ \mu\text{C} \leq C_R \cdot U_R < 470\,000\ \mu\text{C}$ : $I_{lka} \leq 0,006\ \mu\text{A} \cdot \left( \frac{C_R}{\mu\text{F}} \cdot \frac{U_R}{\text{V}} \right) + 4\ \mu\text{A}$	
Self-inductance $L_{ESL}$	$d$ (mm)	6,5   8,5   10   12   14   16   18   21   25
	$l$ (mm)	15,5   15,5   25   30   30   30   39,5   40   40
	$L_{ESL}$ approx. (nH)	14   17   35   37   38   45   57   30   34
IEC climatic category	in accordance with IEC 68-1 40/085/56 (−40 °C/+85 °C, 56 days damp heat test)	
Detail specifications	similar to CECC 30 301-801 (similar to CECC 30 301-003, DIN 45 910 part 123)	
Sectional specifications	IEC 384-4 (DIN 45 910 part 12)	
Vibration resistance	in accordance with IEC 68-2-6, test Fc: displacement amplitude 0,35 mm, frequency range 10 to 55 Hz, acceleration max. 5 g, duration 3 × 2 h	

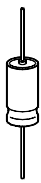

Outline drawing

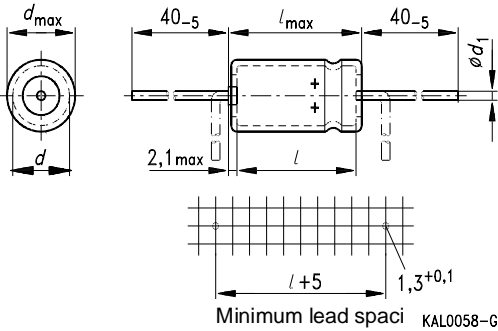

Dimensions (mm)			Approximate weight (g)
$d \times l$	$d_{max} \times l_{max}$	Lead wire diameter $d_1$	
6,5 × 15,5	7,0 × 17	0,6	1,1
8,5 × 15,5	9,0 × 17		1,8
10 × 25	10,5 × 26,5	0,8	3,2
12 × 30	12,5 × 32		5,4
14 × 30	14,5 × 32		7,5
16 × 30	16,5 × 32		9,3
18 × 39,5	18,5 × 40,3		14
21 × 40	21,5 × 41,5		18
25 × 40	25,5 × 41,5		26

Packing units

Case dimensions $d \times l$ (mm)	Bulk PU (pcs.)	Reel packing PU (pcs./reel)
6,5 × 15,5	2000	1300
8,5 × 15,5	1500	1000
10 × 25	900	600
12 × 30	600	450
14 × 30	400	350
16 × 30	350	250
18 × 39,5	250	–
21 × 40	200	–
25 × 40	150	–



**B 41 588**  
**B 43 588**

### Overview of available types

#### Type B 41 588

$U_R$ (V-)	10	16	25	40	63	100
$C_R$ ( $\mu$ F)	Case dimensions $d \times l$ (mm)					
4,7					6,5 × 15,5	8,5 × 15,5
10				6,5 × 15,5	8,5 × 15,5	8,5 × 15,5
22				8,5 × 15,5	8,5 × 15,5	10 × 25
47	6,5 × 15,5	8,5 × 15,5	8,5 × 17,5	8,5 × 15,5	10 × 25	12 × 30
100	8,5 × 15,5	8,5 × 15,5	10 × 25	10 × 25	12 × 30	16 × 30
220	10 × 25	10 × 25	12 × 30	12 × 30	16 × 30	18 × 39,5
470	12 × 30	12 × 30	14 × 30	16 × 30	21 × 40	25 × 40
1 000	14 × 30	16 × 30	18 × 39,5	21 × 40	25 × 40	
2 200	18 × 39,5	18 × 39,5	21 × 40	25 × 40		
4 700	25 × 40	25 × 40				

#### Type B 43 588

$U_R$ (V-)	160	250	350
$C_R$ ( $\mu$ F)	Case dimensions $d \times l$ (mm)		
1,0			6,5 × 15,5
2,2	6,5 × 15,5	8,5 × 15,5	8,5 × 15,5
4,7	8,5 × 15,5	10 × 25	10 × 25
10	10 × 25	10 × 25	12 × 30
22	12 × 30	14 × 30	14 × 30
47	14 × 30	16 × 30	18 × 39,5
100	18 × 39,5	21 × 40	25 × 40
220	25 × 40		

The capacitance and voltage ratings listed above are available in smaller cases upon request. Other voltage and capacitance ratings are also available upon request.

Upon request we also supply special versions with rated voltages of up to 450 V-, surge voltages of up to 600 V- and capacitance ratings of 6,8  $\mu$ F, 10  $\mu$ F, 15  $\mu$ F, 22  $\mu$ F (e. g. for electronic ballast applications).

Temperature range – 40 ... + 85 °C/+ 105 °C.



**Technical data and ordering codes**

$U_R$	$C_R$	Case dimensions $d \times l$ mm	$R_{ESR, typ}$ 100 Hz 20 °C $\Omega$	$R_{ESR, max}$ 100 Hz 20 °C $\Omega$	$Z_{max}$ 10 kHz 20 °C $\Omega$	$I_{-R}$ 100 Hz 40 °C A	$I_{-max}$ 100 Hz 85 °C A	Ordering code <sup>1)</sup>  Short code
<b>B41588-</b>								
10	47	6,5 × 15,5	2,0	5,0	0,88	0,29	0,10	-D3476-T90
	100	8,5 × 15,5	0,95	2,4	0,43	0,49	0,17	-D3107-T90
	220	10 × 25	0,43	1,1	0,21	0,83	0,28	-E3227-T90
	470	12 × 30	0,20	0,50	0,11	1,6	0,55	-C3477-T
	1 000	14 × 30	0,10	0,25	0,07	2,5	0,85	-E3108-T
	2 200	18 × 39,5	0,06	0,14	0,05	4,1	1,4	-C3228-T
	4 700	25 × 40	0,05	0,07	0,05	5,5	1,9	-A3478-T
16	47	8,5 × 15,5	1,6	4,0	0,82	0,34	0,12	-C4476-T90
	100	8,5 × 15,5	0,75	1,9	0,40	0,52	0,18	-D4107-T90
	220	10 × 25	0,36	0,90	0,20	0,96	0,33	-D4227-T90
	470	12 × 30	0,18	0,45	0,11	1,7	0,57	-D4477-T
	1 000	16 × 30	0,10	0,25	0,06	2,7	0,92	-M4108-T
	2 200	18 × 39,5	0,06	0,12	0,05	4,1	1,4	-D4228-T
	4 700	25 × 40	0,05	0,06	0,05	5,5	1,9	-A4478-T
25	47	8,5 × 15,5	1,3	3,3	0,78	0,41	0,14	-D5476-T90
	100	10 × 25	0,60	1,5	0,38	0,70	0,24	-E5107-T90
	220	12 × 30	0,28	0,70	0,19	1,3	0,46	-L5227-T
	470	14 × 30	0,16	0,40	0,10	1,9	0,64	-E5477-T
	1 000	18 × 39,5	0,10	0,19	0,06	3,2	1,1	-D5108-T
	2 200	21 × 40	0,06	0,10	0,05	4,5	1,6	-A5228-T
	40	10	6,5 × 15,5	5,0	13	3,3	0,17	0,06
22		8,5 × 15,5	2,2	5,5	1,5	0,32	0,11	-D7226-T90
47		8,5 × 15,5	1,0	2,5	0,72	0,46	0,16	-E7476-T90
100		10 × 25	0,50	1,3	0,36	0,81	0,28	-E7107-T90
220		12 × 30	0,25	0,63	0,18	1,4	0,49	-D7227-T
470		16 × 30	0,13	0,33	0,10	2,2	0,77	-M7477-T
1 000		21 × 40	0,07	0,16	0,06	4,0	1,4	-D7108-T
2 200		25 × 40	0,04	0,08	0,05	5,9	2,0	-A7228-T

1) For instructions on how to determine ordering codes, refer to [page 283](#).



**B 41 588**  
**B 43 588**

### Technical data and ordering codes

$U_R$	$C_R$	Case dimensions $d \times l$ mm	$R_{ESR, typ}$ 100 Hz 20 °C $\Omega$	$R_{ESR, max}$ 100 Hz 20 °C $\Omega$	$Z_{max}$ 10 kHz 20 °C $\Omega$	$I_{-R}$ 100 Hz 40 °C A	$I_{-max}$ 100 Hz 85 °C A	Ordering code <sup>1)</sup>  Short code
<b>B41588-</b>								
63	4,7	6,5 × 15,5	9,5	24	6,5	0,15	0,05	-K8475-T90
	10	8,5 × 15,5	4,0	10	3,1	0,23	0,08	-K8106-T90
	22	8,5 × 15,5	1,8	4,5	1,4	0,35	0,12	-K8226-T90
	47	10 × 25	0,80	2,0	0,67	0,64	0,22	-K8476-T90
	100	12 × 30	0,40	1,0	0,33	1,1	0,38	-J8107-T
	220	16 × 30	0,18	0,45	0,17	1,9	0,65	-B8227-T
	470	21 × 40	0,10	0,25	0,09	3,3	1,1	-J8477-T
	1 000	25 × 40	0,05	0,12	0,06	5,3	1,8	-A8108-T
100	4,7	8,5 × 15,5	7,0	18	6,0	0,17	0,06	-C9475-T90
	10	8,5 × 15,5	3,0	7,5	2,8	0,26	0,09	-D9106-T90
	22	10 × 25	1,3	3,3	1,3	0,52	0,18	-D9226-T90
	47	12 × 30	0,60	1,5	0,62	0,90	0,31	-D9476-T
	100	16 × 30	0,32	0,80	0,31	1,4	0,49	-E9107-T
	220	18 × 39,5	0,16	0,40	0,15	2,4	0,83	-D9227-T
	470	25 × 40	0,09	0,23	0,09	4,1	1,4	-A9477-T
	<b>B43588-</b>							
160	2,2	6,5 × 15,5	36	80	33	0,07	0,02	-C1225-T90
	4,7	8,5 × 15,5	17	38	15	0,12	0,04	-D1475-T90
	10	10 × 25	8,0	18	7,2	0,19	0,07	-D1106-T90
	22	12 × 30	3,6	8,0	3,3	0,38	0,13	-C1226-T
	47	14 × 30	1,7	3,8	1,6	0,59	0,20	-D1476-T
	100	18 × 39,5	0,80	1,8	0,75	1,1	0,38	-D1107-T
	220	25 × 40	0,40	0,80	0,35	2,0	0,68	-A1227-T
	250	2,2	8,5 × 15,5	29	72	31	0,09	0,03
4,7		10 × 25	14	24	14	0,15	0,05	-C2475-T90
10		10 × 25	6,4	16	6,8	0,24	0,08	-D2106-T90
22		14 × 30	2,9	7,2	3,1	0,45	0,15	-D2226-T
47		16 × 30	1,4	3,4	1,5	0,70	0,24	-M2476-T
100		21 × 40	0,60	1,5	0,70	1,4	0,47	-D2107-T

1) For instructions on how to determine ordering codes, refer to [page 283](#).



**Technical data and ordering codes**

$U_R$	$C_R$	Case dimensions $d \times l$ mm	$R_{ESR, typ}$ 100 Hz 20 °C $\Omega$	$R_{ESR, max}$ 100 Hz 20 °C $\Omega$	$Z_{max}$ 10 kHz 20 °C $\Omega$	$I_{-R}$ 100 Hz 40 °C A	$I_{-max}$ 100 Hz 85 °C A	Ordering code <sup>1)</sup>  Short code
<b>B43588-</b>								
350	1,0	6,5 × 15,5	48	120	64	0,06	0,02	-D4105-T90
	2,2	8,5 × 15,5	22	55	29	0,10	0,04	-D4225-T90
	4,7	10 × 25	10	25	14	0,17	0,06	-D4475-T90
	10	12 × 30	4,8	12	6,4	0,33	0,11	-D4106-T
	22	14 × 30	2,2	5,5	2,9	0,51	0,18	-E4226-T
	47	18 × 39,5	1,0	2,5	1,4	1,0	0,34	-D4476-T
	100	25 × 40	0,50	1,3	0,67	1,7	0,59	-A4107-T

Upon request we also supply special versions with rated voltages of up to 450 V<sub>-</sub>, surge voltages of up to 600 V<sub>-</sub> and capacitance ratings of 6,8 μF, 10 μF, 15 μF, 22 μF (e. g. for electronic ballast applications).

Temperature range – 40 ... + 85 °C/+ 105 °C.

1) To obtain the required ordering code, prefix the type number to the short code. E. g.: B43588-C4105-T  
B41588-... ( $U_R = 10$  to 100 V<sub>-</sub>)  
B43588-... ( $U_R = 160$  to 350 V<sub>-</sub>)

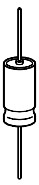

**B 41 588**  
**B 43 588**

**Useful life**

versus ambient temperature  $T_A$  under ripple current operating conditions<sup>1)</sup>

$U_R = 10$  to  $350$  V- ( $d \leq 8,5$  mm)

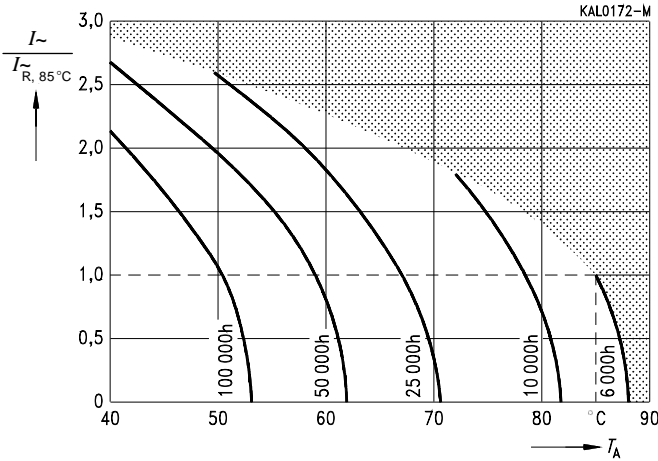

$U_R = 10$  to  $100$  V- ( $d \geq 10$  mm)

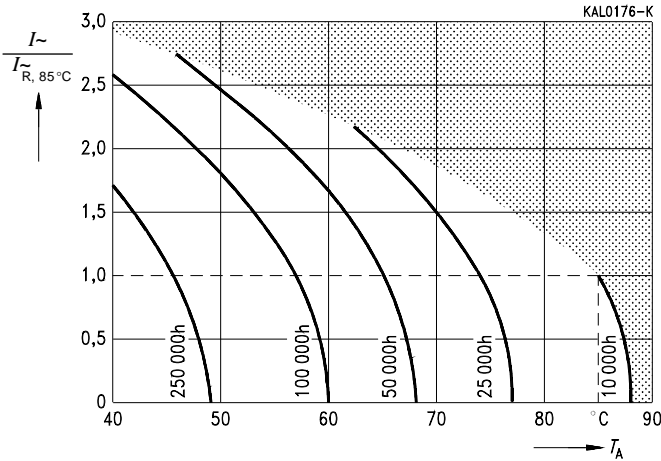

1) Refer to [page 34](#) for an explanation on how to interpret the useful life graphs.



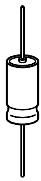

**Useful life**

versus ambient temperature  $T_A$  under ripple current operating conditions<sup>1)</sup>

$U_R = 160$  to  $350$  V- ( $d \geq 10$  mm)

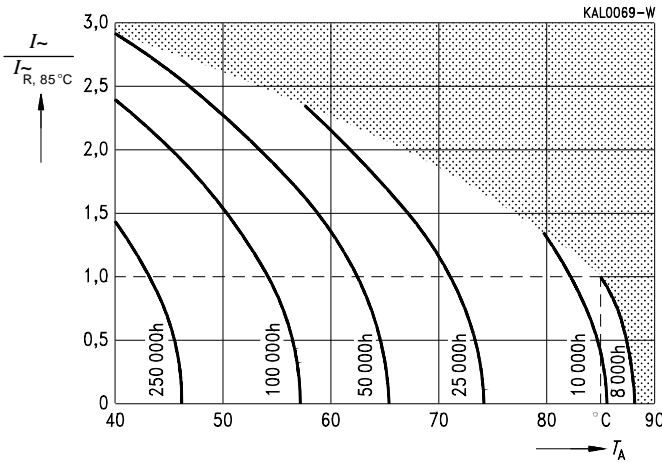

**Permissible ripple current  $I_{\sim}$**   
versus frequency  $f$   
 $U_R \leq 100$  V-

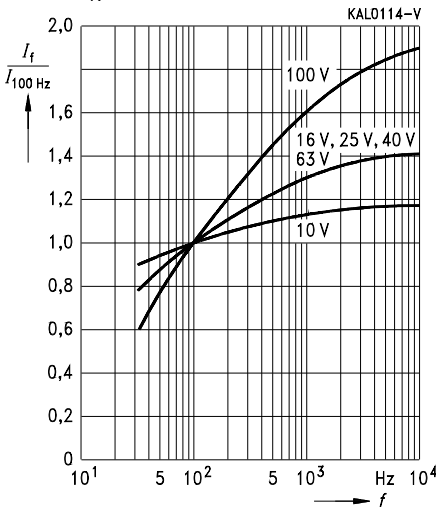

**Permissible ripple current  $I_{\sim}$**   
versus frequency  $f$   
 $U_R \geq 160$  V-

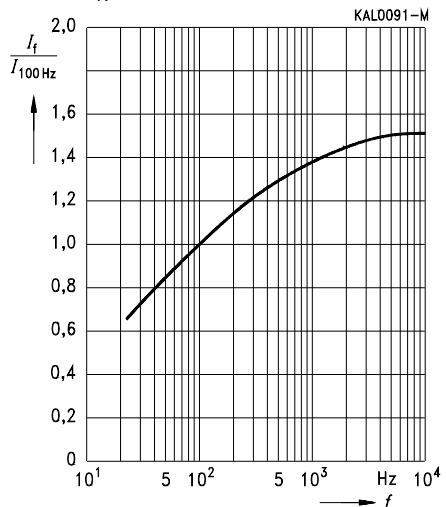

1) Refer to [page 34](#) for an explanation on how to interpret the useful life graphs.



**B 41 588**  
**B 43 588**

**Series capacitance  $C_S$  at  $f = 100$  Hz**  
 versus temperature  $T$   
 Typical behavior  
 $U_R \leq 100$  V-

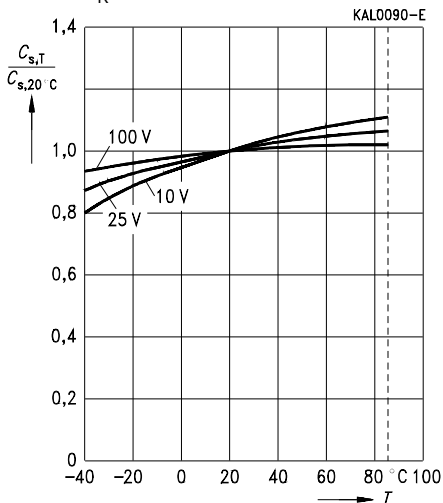

**Series capacitance  $C_S$  at  $f = 100$  Hz**  
 versus temperature  $T$   
 Typical behavior  
 $U_R \geq 160$  V-

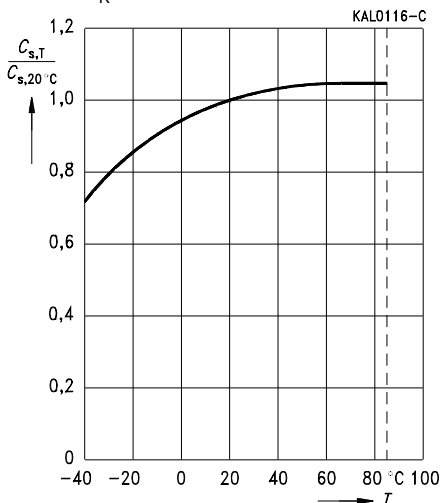

**Equivalent series resistance  $R_{ESR}$**   
 at  $f = 100$  Hz versus temperature  $T$   
 Typical behavior  
 $U_R \leq 100$  V-

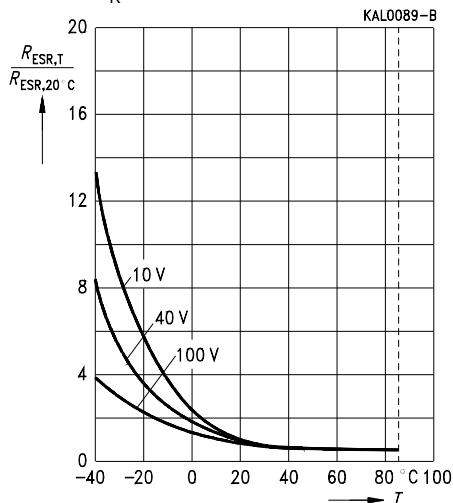

**Impedance  $Z$  at  $f = 100$  Hz**  
 versus temperature  $T$   
 Typical behavior  
 $U_R \geq 160$  V-

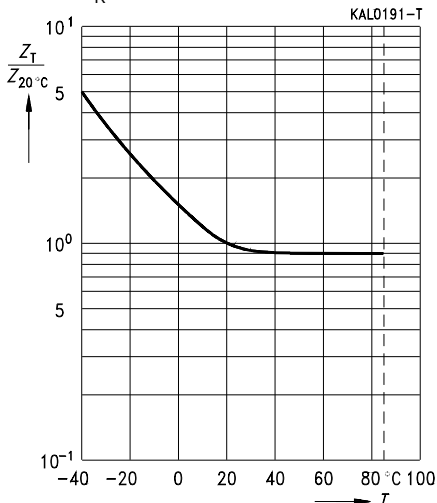

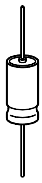

**Impedance  $Z$  at  $f = 10$  kHz**  
versus temperature  $T$   
Typical behavior  
 $U_R \leq 100$  V-

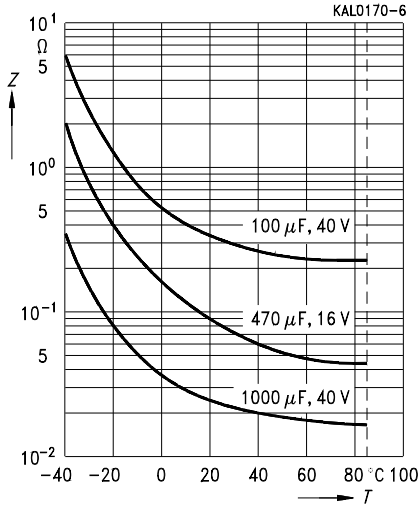

**Impedance  $Z$  at  $f = 10$  kHz**  
versus temperature  $T$   
Typical behavior  
 $U_R \geq 160$  V-

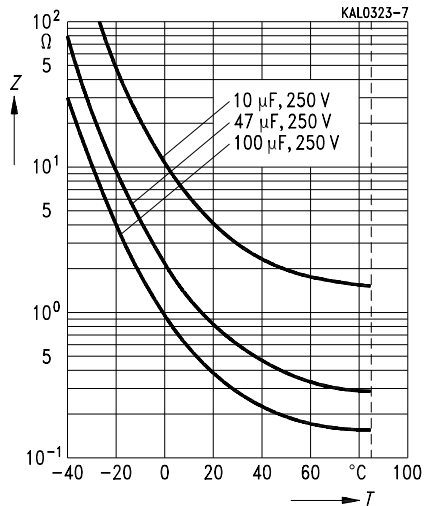

**Impedance  $Z$**   
versus frequency  $f$   
and temperature  $T$  for  $1000 \mu\text{F}/40$  V-  
Typical behavior

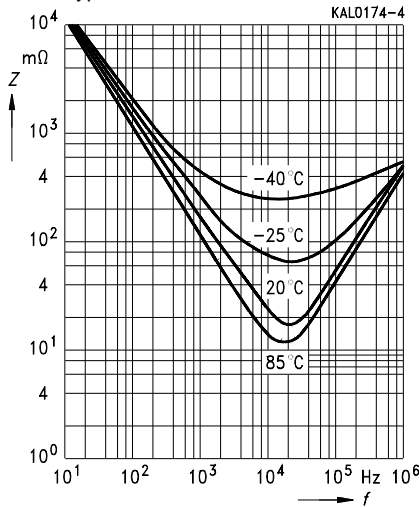

**Impedance  $Z$**   
versus frequency  $f$   
and temperature  $T$  for  $100 \mu\text{F}/250$  V-  
Typical behavior

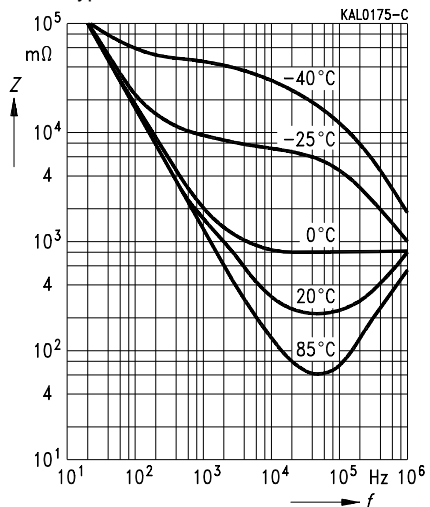

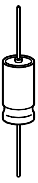

**B 41 588**  
**B 43 588**

**Impedance  $Z$**   
versus frequency  $f$   
Typical values at 20 °C  
 $U_R \leq 100 \text{ V}$ —

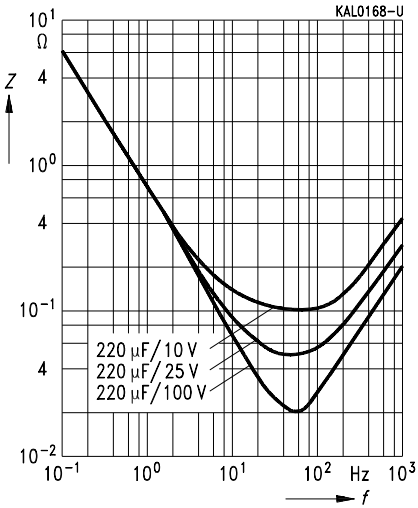

**Impedance  $Z$**   
versus frequency  $f$   
Typical values at 20 °C  
 $U_R \geq 160 \text{ V}$ —

