

TABLE OF CONTENTS

TITLE	PAGE
HIGHLIGHTS	3
NOTES FOR SAFE USAGE	3
FIGURATION AND ACCESSORIES	5
ELECTRIC SYMBOL	7
GENERAL INFORMATION	8
SPECIFICATIONS	9
1.DC Voltage (DCV)	9
2.AC Voltage (ACV)	9
3.DC Current (DCA)	10
4.AC Current (ACA)	10
5.Resistance	10
6.Capacitance	11
7. Inductance	11
8.Auto range frequency test	11
9.Transistor hFE measurement	11
10.Diode	12
11.Continuity Buzzer	12
12.TTL LOGIC Test	12
13.Temperature Test	12
OPERATION INSTRUCTION	14
1. Introduction of functional buttons	15
2. DC Voltage Measurement (DCV)	15
3.AC Voltage Measurement (ACV)	17
4. Current Measurement (DCA)	18
5.AC Current Measurement (ACA)	19
6. Resistance Measurement	20
7. Inductance Measurement (L)	21
8. Capacitance Measurement (C)	22
9. Frequency Measurement (10MHz)	23
10. Temperature Measurement (°C or °F)	24

TABLE OF CONTENTS

TITLE	PAGE
11. Transistor Parameter	
Measurement (hFE) -----	24
12. Diode (or PN node of transistor)	
Measurement(→) -----	25
13. Continuity Buzzer Test (•) -----	25
14. TTL LOGIC Test (◊) -----	26
MAINTENANCE -----	27
FUSE AND BATTERY replacement -----	28
Accessories -----	28

Operating Manual of UT70A Multimeter

HIGHLIGHTS

UT70A Multimeter is a hand-held digital multimeter with advanced design, multiple functions, novel figuration, large display screen and reliable performance. This meter is fully capable to measure voltage and current both AC and DC, resistance, capacitance, inductance, temperature, frequency, forward voltage drop of diode, transistor hFE and continuity test, TTL LOGIC level measurement. It has some extraordinary functions such as holding the measured data and maximum value, providing backlight display in a dim condition, displaying polarity, over-range, low battery, and units icons, and full overloading protection and automatic power off.

NOTES FOR SAFE USAGE

- 1) CE Version: The Meter complies with the standards IEC61010-1:in pollution degree 2, overvoltage category CAT III 1000V, CAT IV 600V and double insulation .
UL Version: The Meter complies with the standards UL61010B-1, in pollution degree 2, overvoltage category CAT II 1000V and double insulation.
CATII: Local level, appliance, PORTABLE EQUIPMENT etc., with smaller transient overvoltages than Installation CategoryIII.
CATIII: Distribution level, fixed installation,with smaller transient overvoltages than CAT IV.
CAT IV: Primary supply level, overhead lines, cablesystems etc.
- 2) Make sure the insulation of the meter in good condition, no damage and break before use.
- 3) Don't use at all unless the back case is in place or there is danger of electric shock.
- 4) Battery should be replaced to ensure an accurate measurement when "  " appears on LCD.

- 5) Set the Range Selector to a proper position.
- 6) The measured value shall not exceed the maximum range of each measurement to protect the meter from damage and electric shock to user.
- 7) Range Selector shall not be switched during measurement to avoid damage to the meter.
- 8) Cautions shall be taken to prevent electric shock when the measured voltage is higher than 60V in DC or 42Vrms in AC.
- 9) Identical fuse shall be used when replacing the fuse:
 $\phi 5 \times 20(\text{mm}) - F 0.5\text{A } 250\text{V}$ or $\phi 5 \times 20(\text{mm}) - F 10\text{A } 250\text{V}$. $\phi 5 \times 20(\text{mm}) - F 0.63\text{A } 250\text{V}$.
- 10) Avoid using the meter in a high temperature and high humidity condition, the performance may deteriorate when the meter is dampened in a wet condition in particular.
- 11) Please use test clips when measuring large size inductor and capacitor to protect the multi-purpose socket from damage.
- 12) This digital multimeter is a precise instrument and its circuit and potentiometer shall not be altered at will.
- 13) Soft cloth and mild detergent may be applied to clean the case for maintenance of this meter while no abrasive or solvent shall be used.
- 14) Reset LC button, leaving LC circuit in Off mode, after a LC measurement for comparatively large LC current.

FIGURATION AND ACCESSORIES

1) The Meter Structure(see figure1)

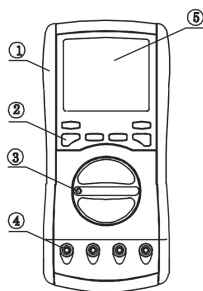

(figure 1)

1. Front case
2. Functional buttons
3. Function/Range selector
4. Input terminal
5. LCD window











2) Input Terminal of UT70A

Input Terminal	Description	For short
10A	Input terminal for current 0.2A-10A.	"A" Terminal
μ A, mA	Input terminal for current 0.01 μ A-0.2A.	"mA"Terminal
V, Ω , Hz, 	Input terminal for voltage, resistance, frequency, diode, continuity, TTL LOGIC.	"V/ Ω " Terminal
COM	Common terminal for current, voltage, resistance, frequency, diode, continuity, TTL LOGIC measurement.	"COM"Terminal

3)Accessories

- 1 Multi-purpose socket: used for measurement of transistor amplification, small capacitor, small inductor and temperature of K type flat plug temperature probe (not included).
- 2 Test clip: used for measurement of large size capacitor and inductor.
- 3 K type cross plug point contact temperature probe: input directly from V/ Ω and mA terminal used for temperature measurement.

ELECTRIC SYMBOL

	AC (Alternating Current)
	DC (Direct Current)
	AC or DC
	Grounding
	Double Insulated
	Deficiency of Built-In Battery
	Continuity buzzer
	Diode
	Fuse
	Warning. Refer to the Operating Manual
	Conforms to Standards of European Union

GENERAL INFORMATION

- l Maximum voltage between any terminal and the ground: 1000V
- l 3 1/2 digits large screen displaying size: 53 mm x 62 mm, Max reading 1999.
- l Simultaneous display function and unit icon.
- l Automatic power off after 15 non-operated minutes
- l Automatic polarity, over range "OL" and low battery icon display.
- l Power: one piece of 9V battery (6F22 or equivalent)
- l Sampling rate: approx. 2.5/sec.
- l Backlight: approx. 10 sec./time.
- l Data hold
- l Maximum value hold
- l Dimensions: 195 x 90 x 40 mm, approx. 600 g. (including holster)
- l Full overloading protection.
- l Operating temperature: 5°C - 40 °C (41 °F - 104 °F), humidity <80%@5°C - 31 °C/<50%@31°C-40 °C.
- l Storage temperature: -10°C - 50 °C (14 °F - 122 °F).
- l Elevation: (operating) 2000 m, (storage) 10000 m.
This meter is suitable for indoor use.

SPECIFICATIONS(1)

Accuracy: $\pm(a\% \text{ reading} + b \text{ digit})$, guarantee for 1 year

Environmental temperature: $23\text{ }^{\circ}\text{C} \pm 5\text{ }^{\circ}\text{C}$

Relative humidity: <80%

1. DC Voltage (DCV)

Range	Resolution	Accuracy	Input protection
200mV	100 μ V	$\pm(0.5\%+1)$	500Vrms
2V	1mV		1000VDC
20V	10mV		750VAC
200V	100mV		
1000V	1V	$\pm(0.8\%+2)$	

Remarks: Input impedance approx. 10M Ω

2. AC Voltage (ACV)

Range	Resolution	Accuracy	Input protection
200mV	100 μ V	$\pm(1.2\%+3)$	500Vrms
2V	1mV	$\pm(0.8\%+3)$	1000VDC
20V	10mV		750VAC
200V	100mV		
750V	1V	$\pm(1.2\%+3)$	

Remarks: Input impedance 10M Frequency response
40 - 400 Hz

Showing effective value of sine wave (mean value response)

SPECIFICATIONS(2)

3.DC Current (DCA)

Range	Resolution	Accuracy	Input protection
20 μ A	0.01 μ A	$\pm(0.8\%+1)$	F. 0.5A/250V
2mA	1 μ A		
200mA	100 μ A	$\pm(1.5\%+1)$	
10A	10mA	$\pm(2\%+5)$	F. 10A/250V

Remarks: at "10A Range" test no more than 10sec. at interval of 15 min.

4. AC Current (ACA)

Range	Resolution	Accuracy	Input protection
20 μ A	0.01 μ A	$\pm(1\%+3)$	F. 0.5A/250V
2mA	1 μ A		
200mA	100 μ A	$\pm(1.8\%+3)$	
10A	10mA	$\pm(3\%+7)$	F. 10A/250V

Remarks: Frequency response 40-400 Hz Showing sine wave effective value(mean value) at "10A Range" test no more than 10sec. at interval of 15 min.

5. Resistance

Range	Resolution	Accuracy
200 Ω	0.1 Ω	$\pm(0.8\%+3)$
2k Ω	1 Ω	$\pm(0.8\%+1)$
20k Ω	10 Ω	
200k Ω	100 Ω	
2M Ω	1k Ω	
20M Ω	10k Ω	$\pm(1\%+5)$
2000M Ω	1M Ω	$\pm[5\%(\text{reading}-10)+10]$

Input protection: 500Vrms

Remarks: It is normal as test response slow at 2000M Ω .

SPECIFICATIONS(3)

6.Capacitance

Range	Resolution	Accuracy	Input protection
20nF	10pF	$\pm(2.5\%+5)$	250Vrms
200nF	100pF		
2 μ F	1nF		
100 μ F	100nF	$\pm(5\%+4)$	

7.Inductance

Range	Resolution	Accuracy	Input protection
2mH	1 μ H	$\pm(2\%+10)$	250Vrms
20mH	10 μ H		
200mH	100 μ H		
20H	10mH	$\pm(3\%+10)$	

Tested inductance: $Q \geq 10$, Internal impedance $\leq 1.3k$

8. Auto range frequency test

Range	Resolution	Accuracy	Input protection
2kHz-10MHz	1Hz (MIN)	$\pm(0.1\%+3)$	500Vrms

Remarks: Input sensitivity ≤ 0.8 Vrms

9.Transistor hFE measurement

Range	Resolution	Description	Test condition
hFE	1 β	hFE approximation (0-1000 β) is shown for the tested transistor (NPN, PNP)	$I_{bo} \approx 10$ A $V_{ce} \approx 2.8V$

SPECIFICATIONS(4)

10. Diode

Range	Resolution	Accuracy	Input protection
	1mV	The shown value is the forward voltage drop of a tested diode PN node.	500 Vrms

Remarks: Open voltage approx. 2.8V Forward circuit current approx. 1mA

11. Continuity Buzzer

Range	Resolution	Accuracy	Input protection
	1Ω	<70Ω.	500 Vrms

12. TTL LOGIC Test

Range	Accuracy	Input protection
TTL LOGIC	Logic high $\geq 2.0V$ Logic low $\leq 0.8V$	500 Vrms

Remarks: Indicated by Buzzer's sound

13. Temperature Test

In Celsius (°C)

Range	Resolution	Accuracy	Input protection
-40 °C - 1000 °C	-40 °C - 0 °C	$\pm(3\%+4)$	250 Vrms
	0 °C - 400 °C	$\pm(1\%+3)$	
	400 °C - 1000 °C	$\pm(2\%+10)$	

SPECIFICATIONS(5)
In Fahrenheit (°F)

Range	Resolution	Accuracy	Input protection
-40 °F 1832 °F	-40 °F - 32 °F	$\pm(3\%+4)$	250 Vrms
	32 °F - 752 °F	$\pm(1\%+4)$	
	752 °F - 1832 °F	$\pm 2.5\%$	



Remarks: Included accessory is an international standard K type (nickel chrome - nickel silicone) cross plug point contact temperature probe that is only applicable for a temperature range $230\text{ }^{\circ}\text{C}$ (446°F).

OPERATION INSTRUCTION(1)

- The sign (Δ) beside the input terminal indicates the maximum value that an input voltage and current shall not exceed in order to protect the internal circuit from damage. Red colour input jack and sign (⚡) express High Voltage Input, reminding you of cautious operation.
- Please don't press down the "LC" functional button to reduce power consumption when conducting measurement other than capacitance and inductance.
- Set Range Selector to your desired range before carrying out measurement. Keep your test lead away from the measured point when changing over function and range.
- Some ranges cannot be reset due to the influence of input impedance, however, it shall not affect the accuracy of measurement.

OPERATION INSTRUCTION(2)

1. Introduction of functional buttons

Button	Function	Operation performed
PEAK	Peak Hold	1. press PEAK button once, the max absolute value measured remains 2. press the button again to release
HOLD	Data Hold	1. press HOLD button once, the measured value shall be hold 2. press the button again to release
LC	Inductance and Capacitance	Press this button for measuring inductance and capacitance in a normal LC mode.
	Backlight	One second after pressing this button, LCD backlight shall start automatically.
	AC & DC Button	Selector for AC and DC voltage and current measurement.
POWER	ON and OFF Button	Functional button of ON and OFF. It shall turn off automatically in case the meter is left unattended for 15 minutes

2. DC Voltage Measurement (DCV)(see figure2)

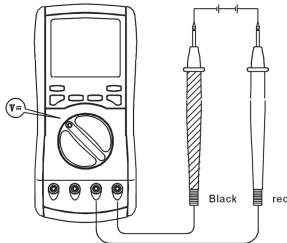

(figure 2)

OPERATION INSTRUCTION(3)

- 1) Insert red test lead into "V/ Ω " jack and black test lead into "COM" jack.
- 2) Set Function/Range Selector to "Required Range".
Set AC/DC Selector to "DC". If the value of voltage to be measured is unknown, select the maximum range first and reduce the range step by step until a satisfactory reading is obtained.
- 3) Connect both points of the tested voltage firmly with the test leads and the tested voltage value shall show on the display immediately.

 **WARNING: Not to measure a Voltage higher than 1000V. A reading might be available but it may result in damage to the internal circuit.**

OPERATION INSTRUCTION(4)

3.AC Voltage Measurement (ACV)(see figure3)

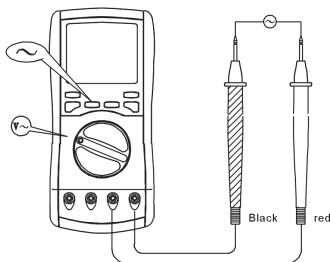

(figure 3)

- 1) Insert red test lead into "V/Ω " jack and black test lead into "COM" jack.
- 2) Set Function/Range Selector to "Required Range". Set AC/DC Selector to "AC". If the value of voltage to be measured is unknown, select the maximum range first and reduce the range step by step until a satisfactory reading is obtained.
- 3) Connect both points of the tested voltage firmly with the test leads and the tested voltage value shall show on the display immediately.

⚠ WARNING: Not to measure a Voltage higher than 750V. A reading might be available but it may result in damage to the internal circuit.

OPERATION INSTRUCTION(5)

4. Current Measurement (DCA)(see figure4)

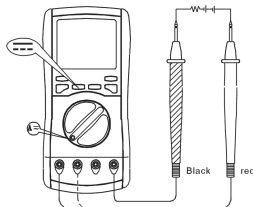

(figure 4)

- 1) Insert red test lead into "mA" jack, (if the tested current higher than 200 mA but less than 10A, set the red test lead into "10A" jack,) and black test lead into "COM" jack.
- 2) Set Function/Range Selector to "Required Range". Set AC/DC Selector to "DC". If the value of current to be measured is unknown, select the maximum range first and reduce the range step by step until a satisfactory reading is obtained.
- 3) Connect both test leads in series with the tested return circuit firmly and the tested return circuit current value shall show on the display immediately.

⚠ WARNING: Turn off the circuit power to be tested before linking the meter with the circuit. Measurement of Voltage in this mode is forbidden.

OPERATION INSTRUCTION(6)

5.AC Current Measurement (ACA)(see figure5)

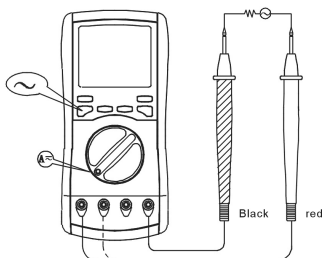

(figure 5)

- 1) Insert red test lead into "mA" jack, (if the tested current higher than 200 mA but less than 10A, set the red test lead into "10A" jack,) and black test lead into "COM" jack.
- 2) Set Function/Range Selector to "Required Range". Set AC/DC Selector to "AC". If the value of current to be measured is unknown, select the maximum range at first and reduce the range step by step until a satisfactory reading is obtained.
- 3) Connect both test leads in series with the tested return circuit firmly and the tested return circuit current value shall show on the display immediately.

⚠ WARNING: Turn off the circuit power to be tested before linking the meter with the circuit. Measurement of Voltage in this mode is forbidden.

OPERATION INSTRUCTION(7)

6. Resistance Measurement (Ω)(see figure6)

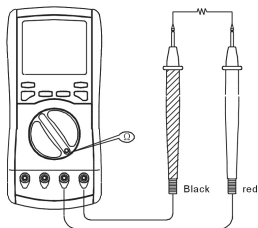

(figure 6)

- 1) Insert the red test lead into "V/ Ω " jack and the black test lead into "COM" jack.
- 2) Set Function/Range Selector to "Required Range", if the value of the resistance to be tested is unknown, select the maximum range at first and reduce the range step by step until a satisfactory reading is obtained.
- 3) Connect the test leads to the tested component or both ends of the return circuit firmly, the resistance value of the tested component or return circuit shall show on the display immediately.
- 4) 2000 M Ω High Resistance Measurement: Before making a measurement of this range, short-circuit both red and black test leads. The display shall show an initial error value in around 10 digits, record this error value. Then connect the object to be tested. Minus the initial error value from the tested value and the result shall be the measured resistance value.

Note: The range of 2000M Ω is applicable to high resistance measurement. It is normal when it responds slowly. When measuring resistance value less than 20M Ω it is suggested to select the range below 20M Ω in order to minimize measuring error.

OPERATION INSTRUCTION(8)

⚠ WARNING: It is not allowed to make a measurement in a live return circuit. Return circuit power shall be cut off and capacitor/s in return circuit shall be discharged (large capacitance value in particular) before measuring. It is forbidden to introduce a voltage signal when a measurement is made.

7. Inductance Measurement (L)(see figure7)

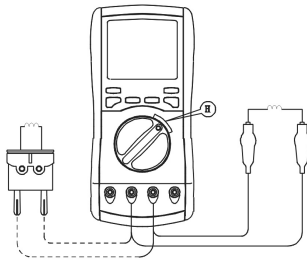

(figure 7)

- 1) Set Function/Range Selector to "Required Range" and press "LC" button down.
- 2) If the value of inductance to be measured is unknown, select the maximum range first and reduce the range step by step until a satisfactory reading is obtained
- 3) Select Multi-purpose socket or test clip according to the size of the inductor's pins to be tested and insert it into two input jacks of "mA" and "V/ Ω " firmly for test and the display shall show the tested inductance value at once.

OPERATION INSTRUCTION(9)

⚠ WARNING: Inductance test shall be stay away from any strong magnetic field to ensure an accurate measurement.

8. Capacitance Measurement (C)(see figure8)

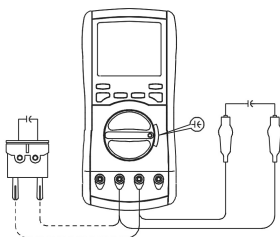

(figure 8)

- 1) Set Function/Range Selector to "C" and press "LC" button down.
- 2) If the value of capacitance to be measured is unknown, select the maximum range first and reduce the range step by step until a satisfactory reading is obtained.
- 3) Select Multi-purpose socket or test clip according to the size of the capacitor's lead to be tested and insert it into two input jacks of "mA" and "V/ Ω " firmly for test and the display shall show the tested capacitance value at once.
- 4) For ensuring the precision, especially in low capacitance 20nF range, the right reading should be the result of the measuring reading minus the open circuit reading.

OPERATION INSTRUCTION(10)

⚠ WARNING: It is not allowed to make measurement of capacitance on live circuit. The capacitor to be tested shall be discharged by short-circuiting before test.

9. Frequency Measurement (10MHz)(see figure9)

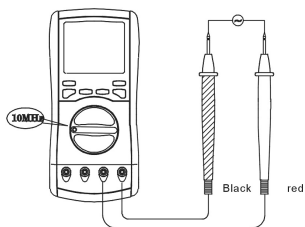

(Figure9)

- 1) Insert the red test lead into " V/Ω " jack and black test lead into "COM" jack.
- 2) Set Function/Range Selector to "10MHz".
- 3) This is an auto-ranged function and the display shall show the tested frequency value as soon as connect both ends of the tested signal with test leads firmly.

OPERATION INSTRUCTION(11)

10. Temperature Measurement ($^{\circ}\text{C}$ or $^{\circ}\text{F}$)(see figure10)

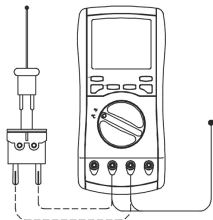

(Figure10)

- 1) Insert firmly the black banana plug of included accessory temperature probe into "mA" jack and red one into "V/Ω" jack. If an optional K type flat plug temperature probe is used, multi-purpose socket shall be completed with. The socket shall be inserted in right direction into "mA" and "V/Ω" input jacks and then insert firmly the temperature probe into the socket with correct polarity.
- 2) Set Function/Range Selector to "TEMP $^{\circ}\text{C}$ ".
- 3) Connect temperature probe tip to the location to be tested and Celsius value of the tested temperature shall be shown on the display instantly.
- 4) Set Function/Range Selector to "TEMP $^{\circ}\text{F}$ " and the tested reading obtained shall be in Fahrenheit value.

11. Transistor Parameter Measurement (hFE)

- 1) Set Function/Range Selector to "hFE".
- 2) Insert the Multi-purpose socket firmly into "mA" and "V/Ω" input jacks in right direction.
- 3) Properly insert Base (B), Emitter (E) and Collector (C) into corresponding jacks depending on PNP or NPN type of the transistor and hFE approximated value of the transistor shall show on the display instantly.

OPERATION INSTRUCTION(12)**12. Diode (or PN node of transistor) Measurement(→)**

- 1) Insert red test lead into "V/ Ω " jacks and black test lead into "COM" jack.
- 2) Set Function /Range Selector to "→ \rightarrow \rightarrow)" position.
- 3) Connect the red and black test leads firmly to the positive and negative (or P and N poles) of a tested diode (or transistor PN node) and the approximated positive voltage drop value of a tested diode (or transistor PN node) shall show on display. The positive voltage drop of a good silicone semiconductor node shall be between 0.5 - 0.8 V.

 **WARNING: No voltage signal shall be introduced into measurement.**

13. Continuity Buzzer Test \rightarrow)

- 1) Insert red test lead into "V/ Ω " jacks and black test lead into "COM" jack.
- 2) Set Function /Range Selector to "→ \rightarrow \rightarrow)" position.
- 3) Connect both ends of the tested component or return circuit properly and firmly with test leads, the built-in buzzer shall sound and " \rightarrow)" icon shall show on display simultaneous when resistance value is less than 70 Ω .

 **WARNING: Continuity buzzer test cannot be made in live return circuit. Power in live return circuit shall be cut off and capacitor (large capacitance value in particular) shall be discharged before test.**

OPERATION INSTRUCTION(13)

14.TTL LOGIC Test \triangle

- 1) Insert red test lead into "V/ Ω " jacks and black test lead into "COM" jack.
- 2) \triangle shall show on LCD when the tested level $\geq 2V$; ∇ shall show on LCD when the tested level is 0.8V and buzzer shall sound as indication. There is no any indication when the tested level ranges between 0.8V to 2 V.

 **WARNING: The tested level should be $\leq 18V$.**

MAINTENANCE

⚠ WARNING! This digital multimeter is a precise electronic instrument and no alternation shall be made to its circuit. Furthermore, the following points shall be attended:

- 1) not connect it to any DC voltage higher than 1000 V or AC voltage higher than 750 V.
- 2) Do not connect the meter directly to any power outlet unless the Function/Range Selector is set on Voltage position.
- 3) Do not use this meter before battery is properly loaded and the back case is closed.
- 4) Do not check or replace battery and fuse unless the meter is cut off and taken away from power when the meter is malfunctions. For disassembly please refer to(see figure11)

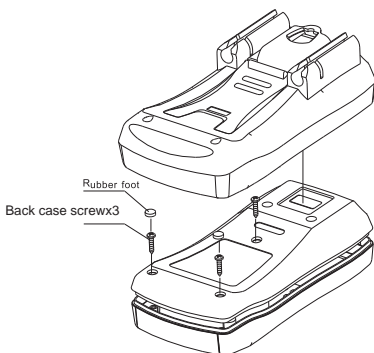

(figure11)

FUSE AND BATTERY replacement

- 1) Turn OFF the Power, and remove the test leads from terminals
- 2) Remove all rubber foot and screws from the back case.
- 3) Separate the back case from the front case.
- 4) Replace the battery or fuse specified in this manual
- 5) Rejoin the back case and front case, reinstall all screws and rubber feet.

Accessories

Included:

- 1) A copy of operating manual
- 2) A pair of test leads
- 3) A piece of cross plug point contact temperature probe
- 4) A pc of multi-purpose socket
- 5) A pair of test clips
- 6) A pc of holster

Optional:

- 1) A pc o f flat plug point contact temperature probe

~ END ~

This operating manual is subject to change without notice.

UNI-T®

Model UT70A: OPERATING MANUAL

UNI-T®

Model UT70A: OPERATING MANUAL

©Copyright 2001 Uni-Trend International Limited.
All rights reserved.

Manufacturer: UNI-TREND TECHNOLOGY(DONG GUAN)LIMITED
Address: Dong Fang Da Dao, Bei Shan Dong Fang Industrial
Development District, Hu Men Town, Dong Guan City,
Guang Dong Province, China

Headquarters: Uni-Trend International Limited
Address: Rm901, 9/F, Nanyang Plaza 57 Hung To Road
Kwun Tong Kowloon, Hong Kong

Tel: (852) 2950 9168
Fax: (852) 2950 9303
Email: info@uni-trend.com
<http://www.uni-trend.com>