

TBA820 • TBA820L

2-WATT AUDIO AMPLIFIER

FAIRCHILD LINEAR INTEGRATED CIRCUITS

GENERAL DESCRIPTION – The TBA820 is an integrated monolithic audio amplifier in a 14-pin plastic power package. It is constructed on a single silicon chip using the Fairchild Planar* epitaxial process. It is intended for use as a low frequency class B amplifier with wide range of supply voltage (3 to 16 V).

The device is supplied in both the quad in-line (TBA820) and the standard dual in-line (TBA820L).

- MINIMUM WORKING VOLTAGE OF 3 V
- LOW QUIESCENT CURRENT
- LOW NUMBER OF EXTERNAL COMPONENTS
- GOOD RIPPLE REJECTION
- NO CROSS-OVER DISTORTION
- TYPICAL OUTPUT POWER:
 - 2 W AT 12 V – 8 Ω
 - 1.6 W AT 9 V – 4 Ω
 - 1.2 W AT 9 V – 8 Ω
 - 0.75 W AT 6 V – 4 Ω

ABSOLUTE MAXIMUM RATINGS

Supply Voltage	16 V
Output Peak Current	1.5 A
Power Dissipation at $T_{amb} = 50^{\circ}C$	1.25 W
Storage and Junction Temperature	$-40^{\circ}C$ to $150^{\circ}C$
Pin Temperature (Soldering 10 s)	$260^{\circ}C$

Thermal Data

θ_{j-amb}	Thermal Resistance Junction-Ambient (copper frame) max	$80^{\circ}C/W$
------------------	--	-----------------

CONNECTION DIAGRAM
14-PIN POWER DIP
 (TOP VIEW)
 PACKAGE OUTLINE 9A, 9C

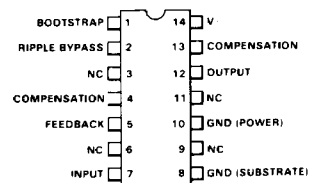

ORDER INFORMATION

TYPE	PART NO.
820 (9C)	TBA820
820L (9A)*	TBA820L

*Recommended for new designs.

EQUIVALENT CIRCUIT

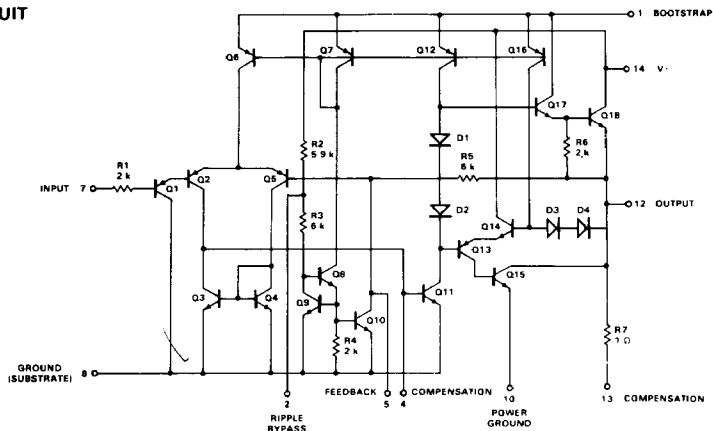

ELECTRICAL CHARACTERISTICS: Power output measured at pin 12, $T_A = 25^\circ\text{C}$ unless otherwise specified.

CHARACTERISTICS	TEST CONDITIONS	MIN	TYP	MAX	UNITS
Supply Voltage		3		16	V
Quiescent Output Voltage (Pin 12)	$V^+ = 9\text{ V}$	4	4.5	5	V
Quiescent Drain Current	$V^+ = 9\text{ V}$		4	12	mA
Bias Current (Pin 7)	$V^+ = 9\text{ V}$		0.1	0.7	μA
Power Output, Figure 1	THD = 10%, $R_{FB} = 120\ \Omega$, $f = 1\text{ kHz}$, $V^+ = 12\text{ V}$, $R_L = 8\ \Omega$ $V^+ = 9\text{ V}$, $R_L = 4\ \Omega$ $V^+ = 9\text{ V}$, $R_L = 8\ \Omega$ $V^+ = 6\text{ V}$, $R_L = 4\ \Omega$ $V^+ = 3.5\text{ V}$, $R_L = 4\ \Omega$	0.9	2 1.6 1.2 0.75 0.22		W W W W W
Input Sensitivity, Figure 1	$P_{OUT} = 1.2\text{ W}$, $R_L = 8\ \Omega$, $V^+ = 9\text{ V}$, $f = 1\text{ kHz}$ $R_{FB} = 33\ \Omega$ $R_{FB} = 120\ \Omega$		16 60		mV mV
Input Sensitivity, Figure 1	$P_{OUT} = 50\text{ mW}$, $R_L = 8\ \Omega$, $V^+ = 9\text{ V}$, $f = 1\text{ kHz}$ $R_{FB} = 33\ \Omega$ $R_{FB} = 120\ \Omega$		3.5 12		mV mV
Input Resistance			5		M Ω
Frequency Response (-3 dB) Figure 1	$V^+ = 9\text{ V}$, $R_L = 8\ \Omega$, $R_{FB} = 120\ \Omega$ $C_{FB} = 680\text{ pF}$ $C_{FB} = 220\text{ pF}$		25 - 7000 25 - 20,000		Hz Hz
Total Harmonic Distortion Figure 1	$P_{OUT} = 500\text{ mW}$, $R_L = 8\ \Omega$, $V^+ = 9\text{ V}$, $f = 1\text{ kHz}$ $R_{FB} = 33\ \Omega$ $R_{FB} = 120\ \Omega$		0.8 0.4		% %
Voltage Gain (Open Loop)	$V^+ = 9\text{ V}$, $R_L = 8\ \Omega$, $f = 1\text{ kHz}$		75		dB
Voltage Gain (Closed Loop)	$V^+ = 9\text{ V}$, $R_L = 8\ \Omega$, $f = 1\text{ kHz}$ $R_{FB} = 33\ \Omega$ $R_{FB} = 120\ \Omega$	31	45 34	37	dB dB
Input Noise Voltage	$V^+ = 9\text{ V}$, BW (-3.0 dB) = 25-20,000 Hz		3		μV
Input Noise Current	$V^+ = 9\text{ V}$, BW (-3.0 dB) = 25-20,000 Hz		0.4		nA
Signal Plus Noise to Noise Ratio	$V^+ = 9\text{ V}$, $R_L = 8\ \Omega$, $R_{FB} = 120\ \Omega$ BW (-3.0 dB) = 25-20,000 Hz $R_1 = 100\text{ k}\Omega$, $P_{OUT} = 1.2\text{ W}$		70		dB
Supply Voltage Rejection, Figure 2	$V = 9\text{ V}$, $R_L = 8\ \Omega$, f (ripple) = 100 Hz, $C_6 = 50\ \mu\text{F}$, $R_{FB} = 120\ \Omega$		42		dB

4

TYPICAL PERFORMANCE CURVES

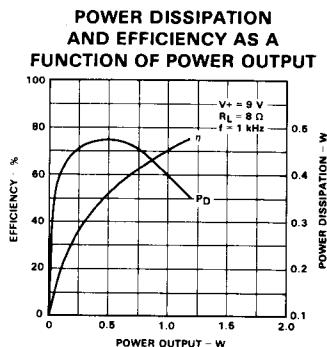
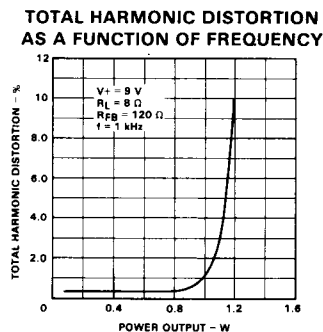
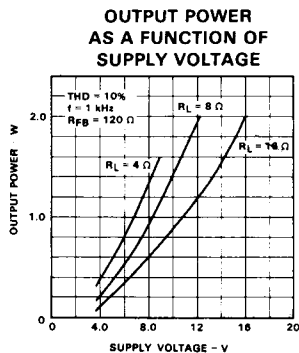

TYPICAL PERFORMANCE CURVES (Cont'd)

MAXIMUM POWER DISSIPATION (SINE WAVE OPERATION) AS A FUNCTION OF SUPPLY VOLTAGE

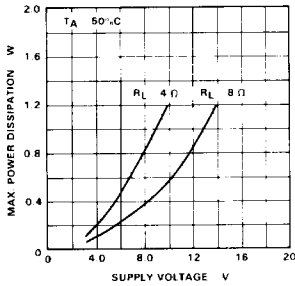

TYPICAL VALUE OF C_{FB} AS A FUNCTION OF R_{FB}

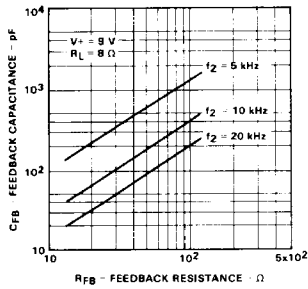

TYPICAL RELATIVE FREQUENCY RESPONSE

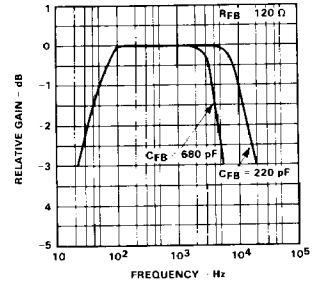

INPUT SENSITIVITY AS A FUNCTION OF R_{FB}

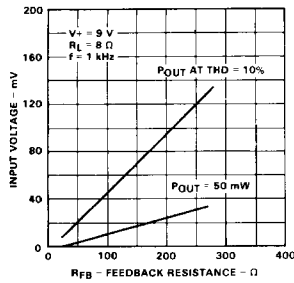

TYPICAL VOLTAGE GAIN (CLOSED LOOP) AS A FUNCTION OF R_{FB}

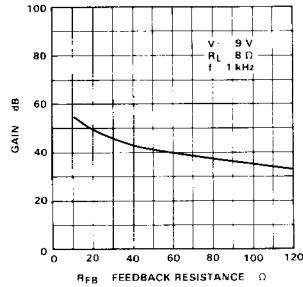

TOTAL HARMONIC DISTORTION AS A FUNCTION OF FREQUENCY

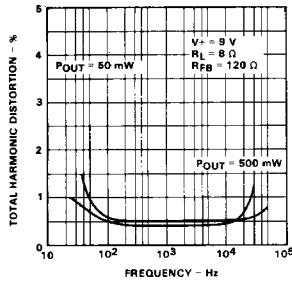

SUPPLY VOLTAGE REJECTION AS A FUNCTION OF R_{FB} FOR FIG. 1 CIRCUIT

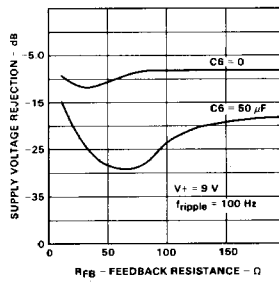

SUPPLY VOLTAGE REJECTION AS A FUNCTION OF R_{FB} (FIG. 2 CIRCUIT)

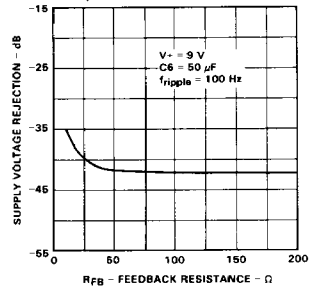

QUIESCENT CURRENT AS A FUNCTION OF SUPPLY VOLTAGE

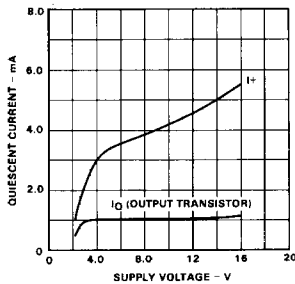

QUIESCENT OUTPUT VOLTAGE AT PIN 12 AS A FUNCTION OF SUPPLY VOLTAGE

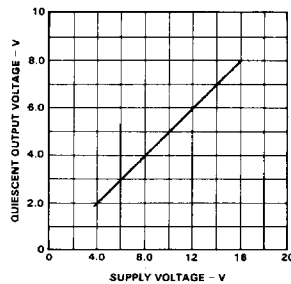

POWER RATING CHART AS A FUNCTION OF AMBIENT TEMPERATURE

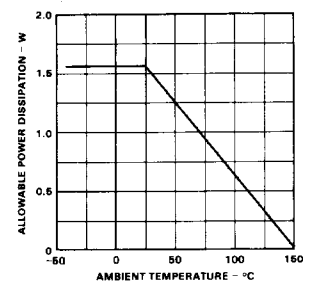

TEST AND APPLICATION CIRCUITS

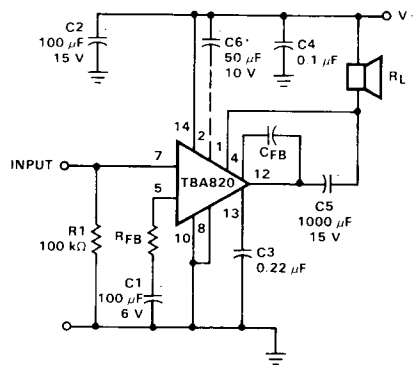

Fig. 1. Circuit Diagram with Load Connected to the Supply Voltage

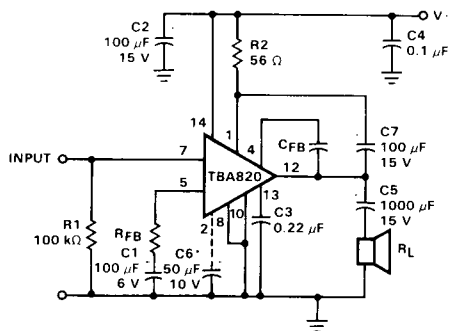

Fig. 2. Circuit Diagram with Load Connected to Ground

*Capacitor C6 must be used when high ripple rejection is desired.

This datasheet has been downloaded from:

www.DatasheetCatalog.com

Datasheets for electronic components.