

uA733C, uA733M DIFFERENTIAL VIDEO AMPLIFIERS

SLFS027A – NOVEMBER 1970 – REVISED MARCH 1993

- 200-MHz Bandwidth
- 250-k Ω Input Resistance
- Selectable Nominal Amplification of 10, 100, or 400
- No Frequency Compensation Required
- Designed to be Interchangeable With Fairchild uA733C and uA733M

description

The uA733 is a monolithic two-stage video amplifier with differential inputs and differential outputs.

Internal series-shunt feedback provides wide bandwidth, low phase distortion, and excellent gain stability. Emitter-follower outputs enable the device to drive capacitive loads, and all stages are current-source biased to obtain high common-mode and supply-voltage rejection ratios.

Fixed differential amplification of 10 V/V, 100 V/V, or 400 V/V may be selected without external components, or amplification may be adjusted from 10 V/V to 400 V/V by the use of a single external resistor connected between 1A and 1B. No external frequency-compensating components are required for any gain option.

The device is particularly useful in magnetic-tape or disc-file systems using phase or NRZ encoding and in high-speed thin-film or plated-wire memories. Other applications include general-purpose video and pulse amplifiers where wide bandwidth, low phase shift, and excellent gain stability are required.

The uA733C is characterized for operation from 0°C to 70°C; the uA733M is characterized for operation over the full military temperature range of –55°C to 125°C.

uA733C . . . D OR N PACKAGE
uA733M . . . J PACKAGE
(TOP VIEW)

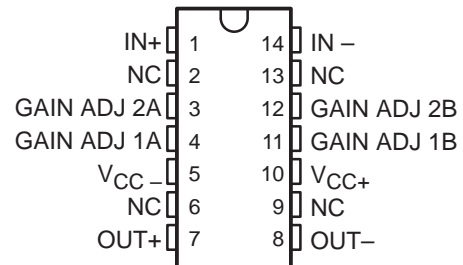

NC — No internal connection

uA733M . . . U PACKAGE
(TOP VIEW)

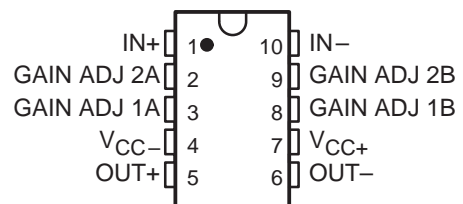

symbol

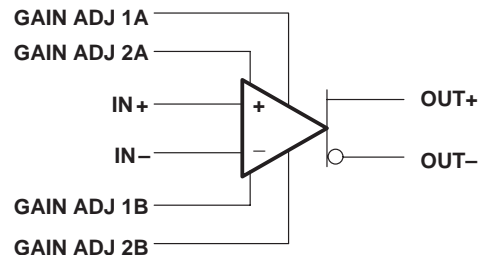

uA733C, uA733M
DIFFERENTIAL VIDEO AMPLIFIERS

SLFS027A – NOVEMBER 1970 – REVISED MARCH 1993

schematic

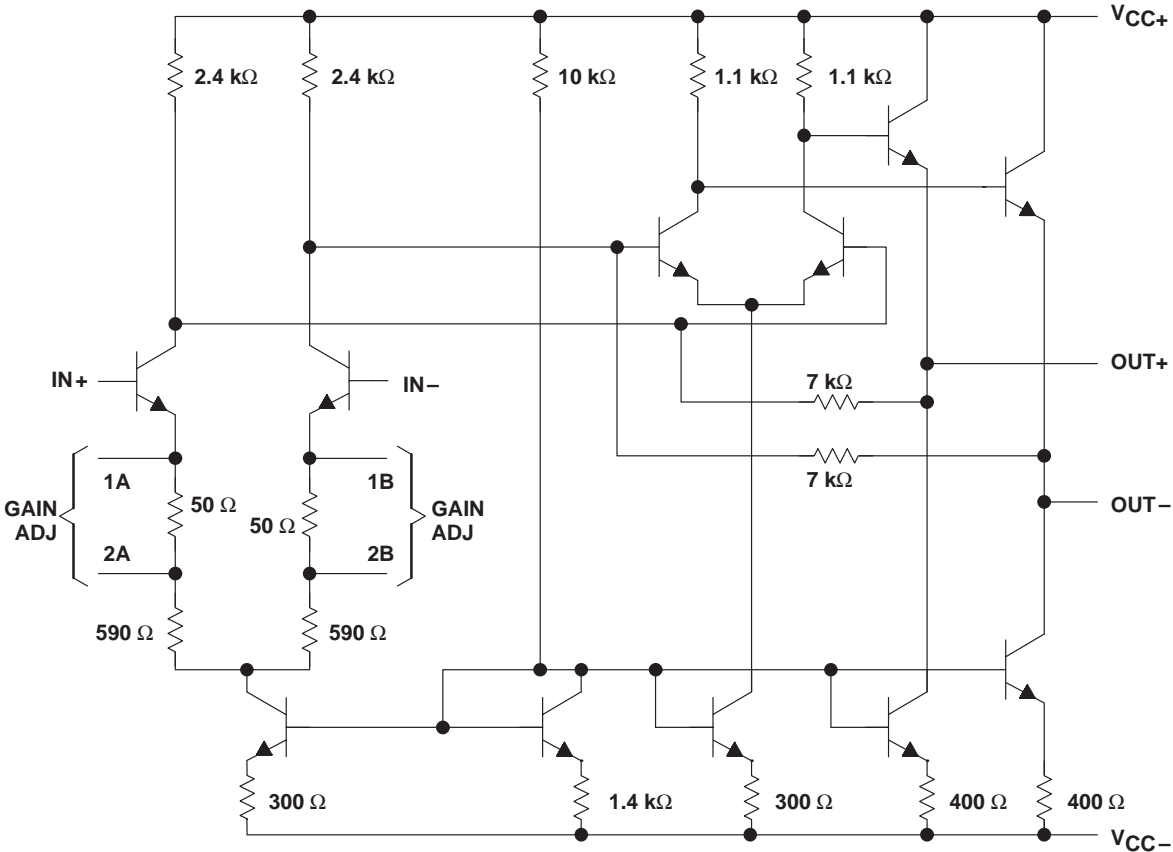

Component values shown are nominal.

Component values shown are nominal.

uA733C, uA733M DIFFERENTIAL VIDEO AMPLIFIERS

SLFS027A – NOVEMBER 1970 – REVISED MARCH 1993

absolute maximum ratings over operating free-air temperature range (unless otherwise noted)†

	uA733C	uA733M	UNIT
Supply voltage V_{CC+} (see Note 1)	8	8	V
Supply voltage V_{CC-} (see Note 1)	-8	-8	V
Differential input voltage	± 5	± 5	V
Common-mode input voltage	± 6	± 6	V
Output current	10	10	mA
Continuous total power dissipation	See Dissipation Rating Table		
Operating free-air temperature range	0 to 70	-55 to 125	°C
Storage temperature range	-65 to 150	-65 to 150	°C
Lead temperature 1,6 mm (1/16 inch) from case for 60 seconds	J or U package	300	°C
Lead temperature 1,6 mm (1/16 inch) from case for 10 seconds	D or N package	260	°C

† Stresses beyond those listed under absolute maximum ratings may cause permanent damage to the device. This is a stress rating only, and functional operation of the device at these or any other conditions beyond those indicated in the recommended operating conditions section of this specification is not implied. Exposure to absolute-maximum-rated conditions for extended periods may affect device reliability.

NOTE 1: All voltage values, except differential input voltages, are with respect to the midpoint between V_{CC+} and V_{CC-} .

DISSIPATION RATING TABLE

PACKAGE	$T_A \leq 25^\circ\text{C}$ POWER RATING	DERATING FACTOR	DERATE ABOVE T_A	$T_A = 70^\circ\text{C}$ POWER RATING	$T_A = 125^\circ\text{C}$ POWER RATING
D	500 mW	N/A	N/A	500 mW	N/A
J (uA733M)	500 mW	11.0 mW/°C	104°C	500 mW	269 mW
N	500 mW	N/A	N/A	500 mW	N/A
U	500 mW	5.4 mW/°C	57°C	430 mW	133 mW

uA733C, uA733M DIFFERENTIAL VIDEO AMPLIFIERS

SLFS027A – NOVEMBER 1970 – REVISED MARCH 1993

electrical characteristics, $V_{CC\pm} = \pm 6\text{ V}$, $T_A = 25^\circ\text{C}$

PARAMETER	FIGURE	TEST CONDITIONS	GAIN OPTION†	uA733C			uA733M			UNIT	
				MIN	TYP	MAX	MIN	TYP	MAX		
AVD	1	$V_{OD} = 1\text{ V}$	1	250	400	600	300	400	500	V/V	
			2	80	100	120	90	100	110		
			3	8	10	12	9	10	11		
BW	2	$R_S = 50\ \Omega$	1	50			50			MHz	
			2	90			90				
			3	200			200				
I_{IO}	Input offset current		Any	0.4	5	0.4	3	μA			
I_{IB}	Input bias current		Any	9	30	9	20	μA			
V_{ICR}	Common-mode input voltage range		Any	± 1			± 1			V	
V_{OC}	Common-mode output voltage		Any	2.4	2.9	3.4	2.4	2.9	3.4	V	
V_{OO}	Output offset voltage	1	1	0.6	1.5	0.6	1.5			V	
			2 & 3	0.35	1.5	0.35	1				
V_{OPP}	Maximum peak-to-peak output voltage swing	1	Any	3	4.7	3	4.7		V		
r_i	Input resistance	3	$V_{OD} \leq 1\text{ V}$	1	4			4			k Ω
				2	10	24	20	24			
				3	250			250			
r_o	Output resistance			20			20			Ω	
C_i	Input capacitance	3	$V_{OD} \leq 1\text{ V}$	2	2			2			pF
CMRR	Common-mode rejection ration	4	$V_{IC} = \pm 1\text{ V}$, $f \leq 100\text{ kHz}$	2	60	86	60	86		dB	
			$V_{IC} = \pm 1\text{ V}$, $f = 5\text{ MHz}$	2	70			70			
k_{SVR}	Supply voltage rejection ratio ($\Delta V_{CC}/\Delta V_{IO}$)	1	$\Delta V_{CC\pm} = \pm 0.5\text{ V}$	2	50	70	50	70		dB	
V_n	Broadband equivalent input noise voltage	5	$BW = 1\text{ kHz to } 10\text{ MHz}$	Any	12			12			μV
t_{pd}	Propagation delay time	2	$R_S = 50\ \Omega$, Output voltage step = 1 V	1	7.5			7.5			ns
				2	6.0	10	6.0	10			
				3	3.6			3.6			
t_r	Rise time	2	$R_S = 50\ \Omega$, Output voltage step = 1 V	1	10.5			10.5			ns
				2	4.5	12	4.5	10			
				3	2.5			2.5			
$I_{sink(max)}$	Maximum output sink current			Any	2.5	3.6	2.5	3.6		mA	
I_{CC}	Supply current		No load, No signal	Any	16	24	16	24		mA	

† The gain option is selected as follows:

Gain Option 1 . . . Gain-adjust pin 1A is connected to pin 1B, and pins 2A and 2B are open.

Gain Option 2 . . . Gain-adjust pin 1A and pin 1B are open, pin 2A is connected to pin 2B.

Gain Option 3 . . . All four gain-adjust pins are open.



electrical characteristics, $V_{CC\pm} = \pm 6\text{ V}$, $T_A = 0^\circ\text{C}$ to 70°C for uA733C, -55°C to 125°C for uA733M

PARAMETER	FIGURE	TEST CONDITIONS	GAIN OPTION†	uA733C		uA733M		UNIT	
				MIN	MAX	MIN	MAX		
A_{VD}	Large-signal differential voltage amplification	1	$V_{OD} = 1\text{ V}$	1	250	600	200	600	V/V
				2	80	120	80	120	
				3	8	12	8	12	
I_{IO}	Input offset current			Any		6		5	μA
I_{IB}	Input bias current			Any		40		40	μA
V_{ICR}	Common-mode input voltage range	1		Any	± 1		± 1		V
V_{OO}	Output offset voltage	1		1		1.5		1.5	V
				2 & 3		1.5		1.2	
V_{OPP}	Maximum peak-to-peak output voltage swing	1		Any	2.8		2.5		V
r_i	Input resistance	3	$V_{OD} \leq 1\text{ V}$	2	8		8		$\text{k}\Omega$
CMRR	Common-mode rejection ratio	4	$V_{IC} = +1\text{ V}$, $f \leq 100\text{ kHz}$	2	50		50		dB
k_{SVR}	Supply voltage rejection ratio ($\Delta V_{CC}/\Delta V_{IO}$)	1	$\Delta V_{CC\pm} = \pm 0.5\text{ V}$	2	50		50		dB
$I_{\text{sink(max)}}$	Maximum output sink current			Any	2.5		2.2		mA
I_{CC}	Supply current		No load, No signal	Any		27		27	mA

† The gain option is selected as follows:

Gain Option 1 . . . Gain-adjust pin 1A is connected to pin 1B, and pins 2A and 2B are open.

Gain Option 2 . . . Gain-adjust pin 1A and pin 1B are open, pin 2A is connected to pin 2B.

Gain Option 3 . . . All four gain-adjust pins are open.

uA733C, uA733M DIFFERENTIAL VIDEO AMPLIFIERS

SLFS027A – NOVEMBER 1970 – REVISED MARCH 1993

PARAMETER MEASUREMENT INFORMATION

test circuits

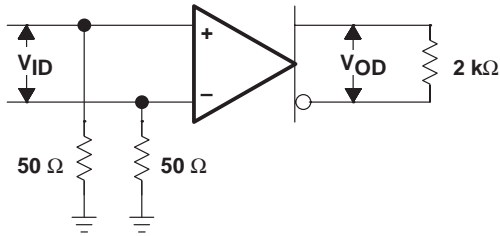

Figure 1

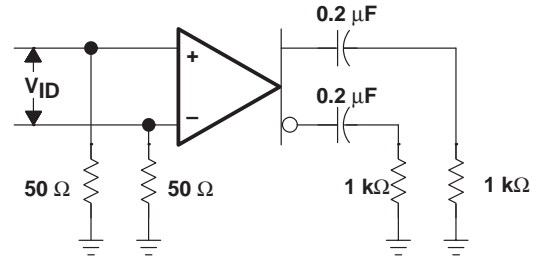

Figure 2

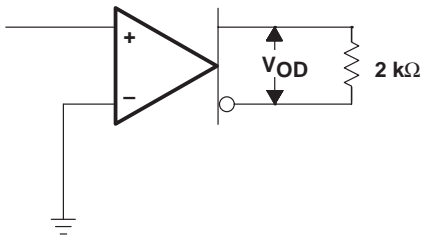

Figure 3

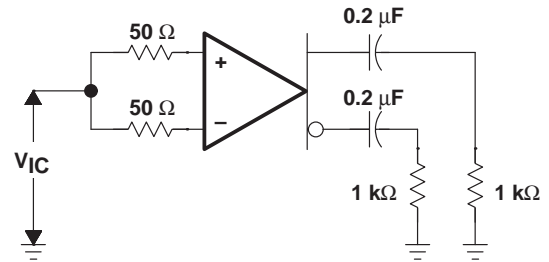

Figure 4

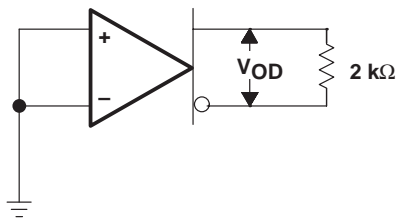
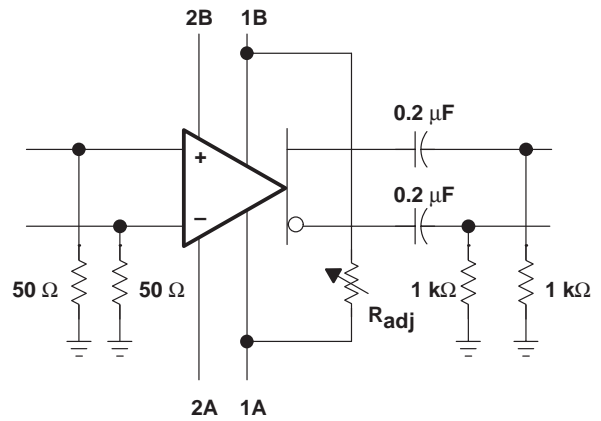

Figure 5



VOLTAGE AMPLIFICATION ADJUSTMENT

Figure 6

TYPICAL CHARACTERISTICS

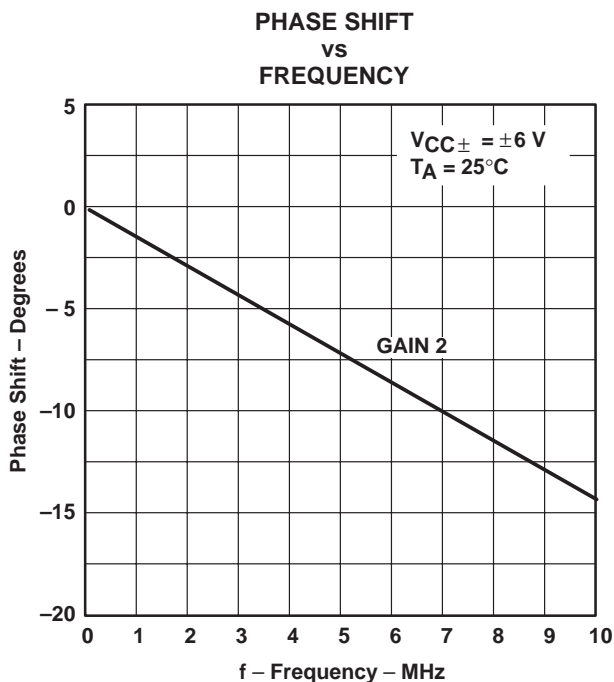

Figure 7

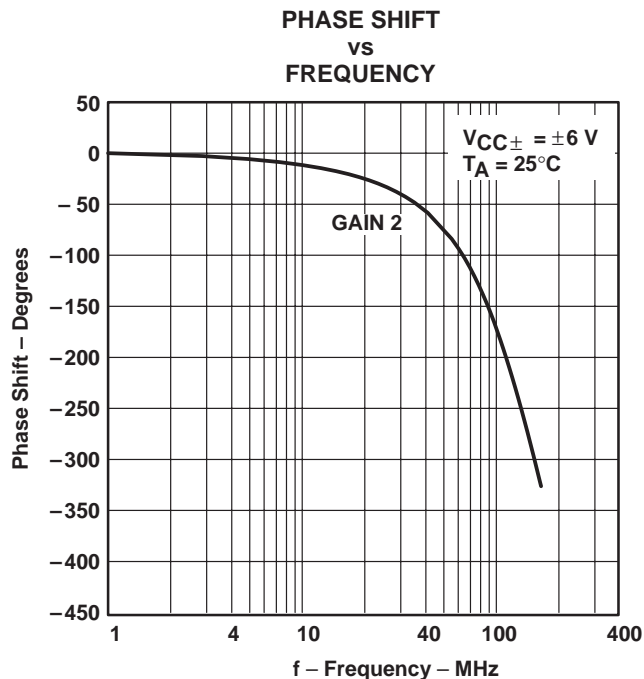

Figure 8

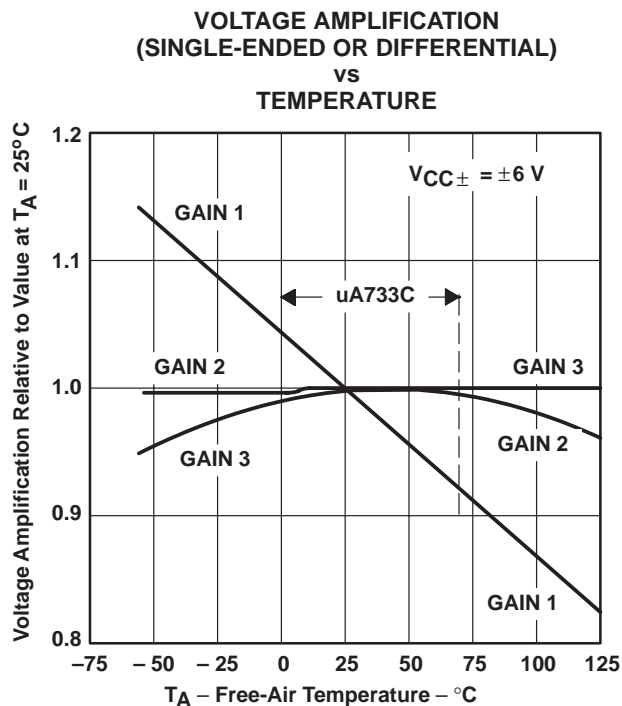

Figure 9

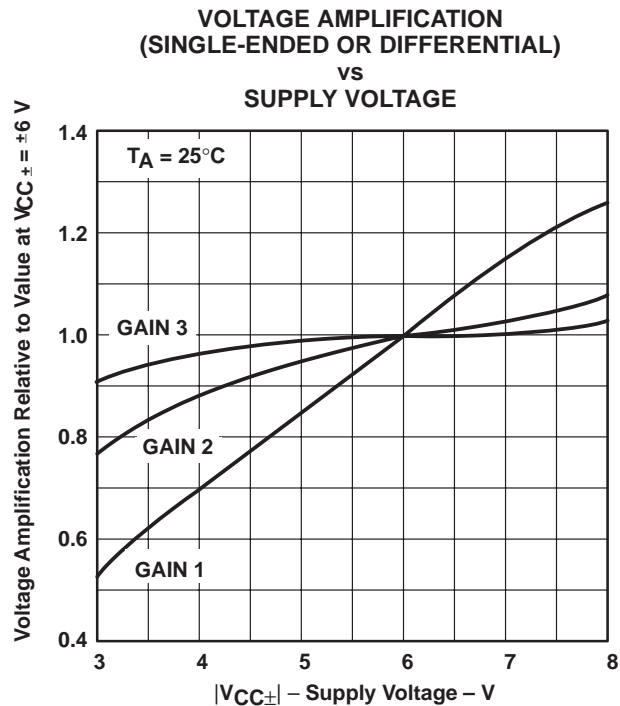

Figure 10

uA733C, uA733M DIFFERENTIAL VIDEO AMPLIFIERS

SLFS027A – NOVEMBER 1970 – REVISED MARCH 1993

TYPICAL CHARACTERISTICS

**DIFFERENTIAL VOLTAGE AMPLIFICATION
vs
RESISTANCE BETWEEN G1A AND G1B**

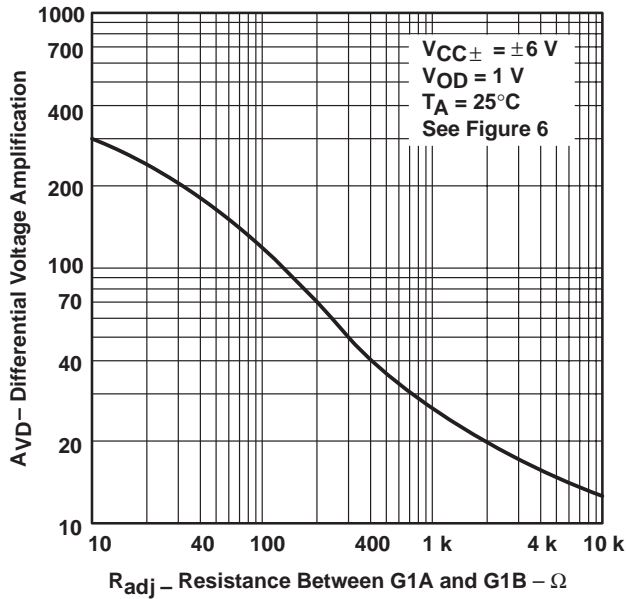

Figure 11

**SINGLE-ENDED VOLTAGE AMPLIFICATION
vs
FREQUENCY**

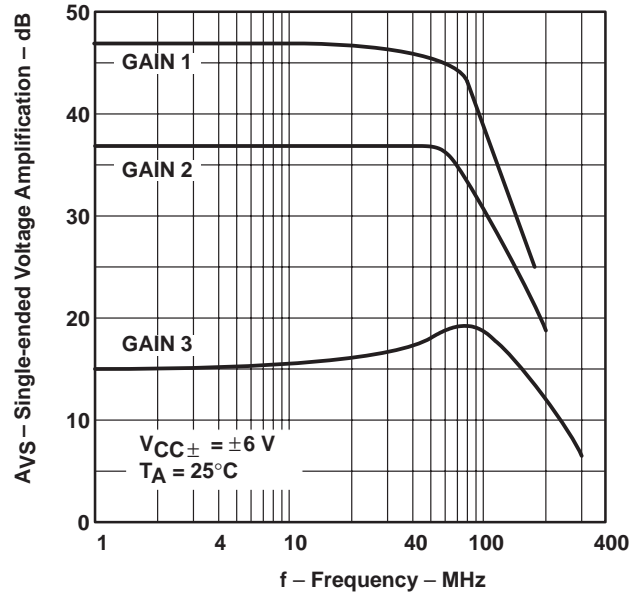

Figure 12

**SUPPLY CURRENT
vs
FREE-AIR TEMPERATURE**

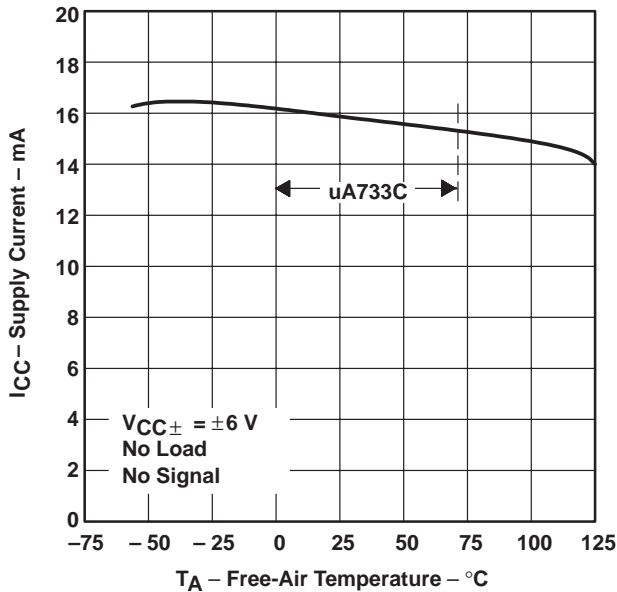

Figure 13

**SUPPLY CURRENT
vs
SUPPLY VOLTAGE**

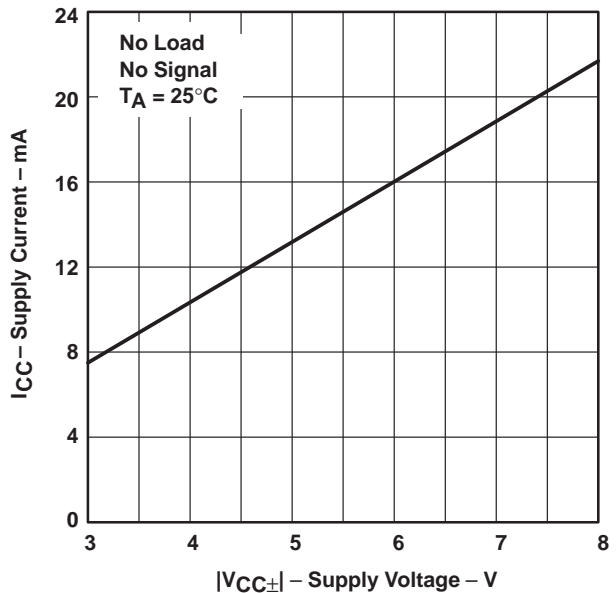

Figure 14



TYPICAL CHARACTERISTICS

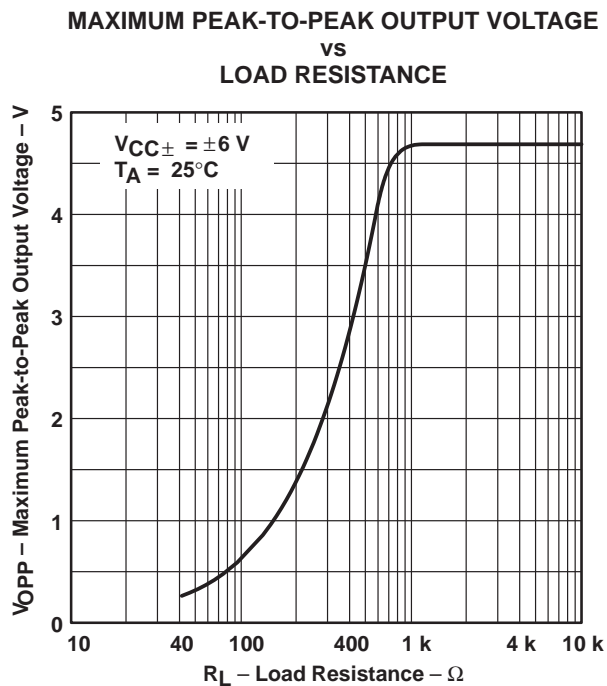

Figure 15

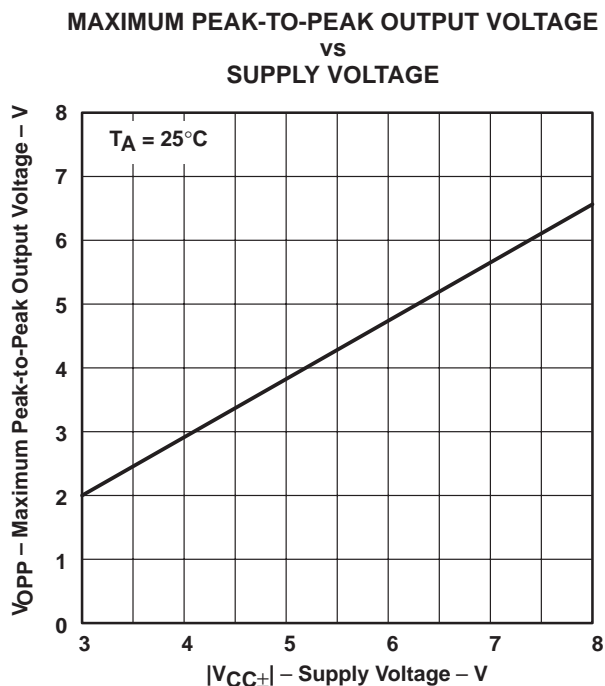

Figure 16

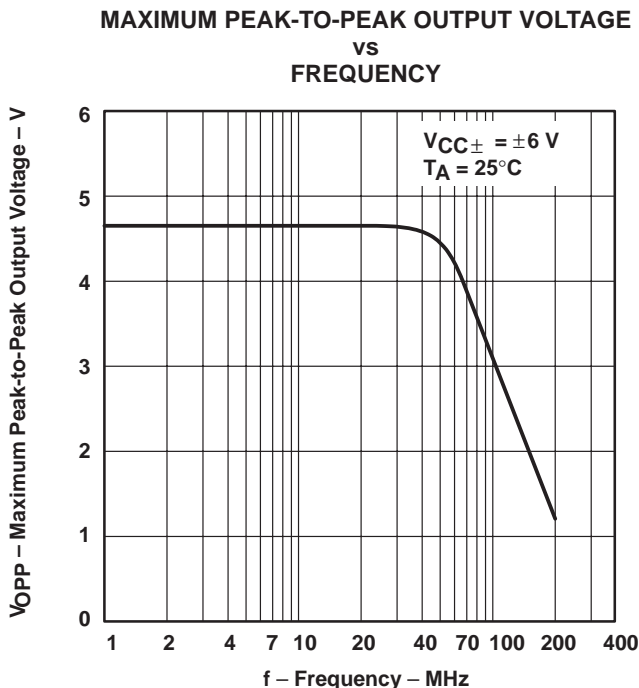

Figure 17

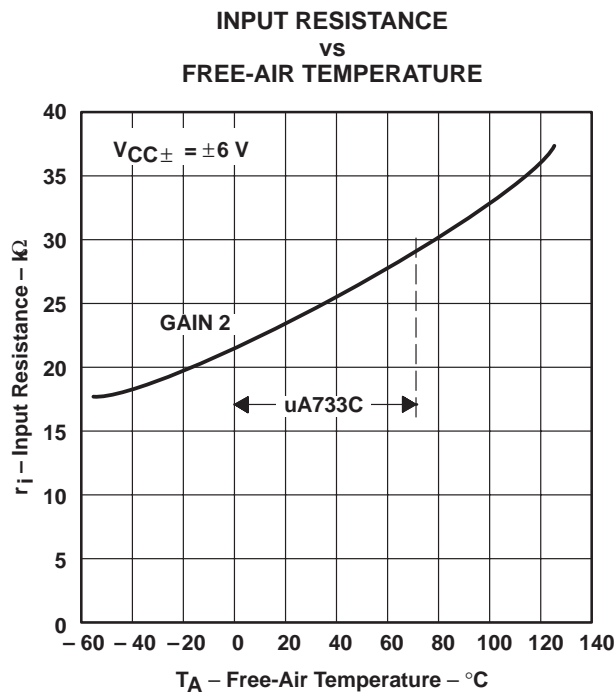

Figure 18

IMPORTANT NOTICE

Texas Instruments and its subsidiaries (TI) reserve the right to make changes to their products or to discontinue any product or service without notice, and advise customers to obtain the latest version of relevant information to verify, before placing orders, that information being relied on is current and complete. All products are sold subject to the terms and conditions of sale supplied at the time of order acknowledgement, including those pertaining to warranty, patent infringement, and limitation of liability.

TI warrants performance of its semiconductor products to the specifications applicable at the time of sale in accordance with TI's standard warranty. Testing and other quality control techniques are utilized to the extent TI deems necessary to support this warranty. Specific testing of all parameters of each device is not necessarily performed, except those mandated by government requirements.

CERTAIN APPLICATIONS USING SEMICONDUCTOR PRODUCTS MAY INVOLVE POTENTIAL RISKS OF DEATH, PERSONAL INJURY, OR SEVERE PROPERTY OR ENVIRONMENTAL DAMAGE ("CRITICAL APPLICATIONS"). TI SEMICONDUCTOR PRODUCTS ARE NOT DESIGNED, AUTHORIZED, OR WARRANTED TO BE SUITABLE FOR USE IN LIFE-SUPPORT DEVICES OR SYSTEMS OR OTHER CRITICAL APPLICATIONS. INCLUSION OF TI PRODUCTS IN SUCH APPLICATIONS IS UNDERSTOOD TO BE FULLY AT THE CUSTOMER'S RISK.

In order to minimize risks associated with the customer's applications, adequate design and operating safeguards must be provided by the customer to minimize inherent or procedural hazards.

TI assumes no liability for applications assistance or customer product design. TI does not warrant or represent that any license, either express or implied, is granted under any patent right, copyright, mask work right, or other intellectual property right of TI covering or relating to any combination, machine, or process in which such semiconductor products or services might be or are used. TI's publication of information regarding any third party's products or services does not constitute TI's approval, warranty or endorsement thereof.

This datasheet has been download from:

www.datasheetcatalog.com

Datasheets for electronics components.