

30 A, 600 V, Ultrafast Diode

Description

The RURG3060 is an ultrafast diode with low forward voltage drop. This device is intended for use as freewheeling and clamping diodes in a variety of switching power supplies and other power switching applications. It is specially suited for use in switching power supplies and industrial application.

Ordering Information

PART NUMBER	PACKAGE	BRAND
RURG3060	TO-247-2L	RURG3060

NOTE: When ordering, use the entire part number.

Symbol



Features

- Ultrafast Recovery $t_{rr} = 60$ ns (@ $I_F = 30$ A)
- Max Forward Voltage, $V_F = 1.5$ V (@ $T_C = 25^\circ\text{C}$)
- 600 V Reverse Voltage and High Reliability
- Avalanche Energy Rated
- RoHS Compliant

Applications

- Switching Power Supplies
- Power Switching Circuits
- General Purpose

Packaging

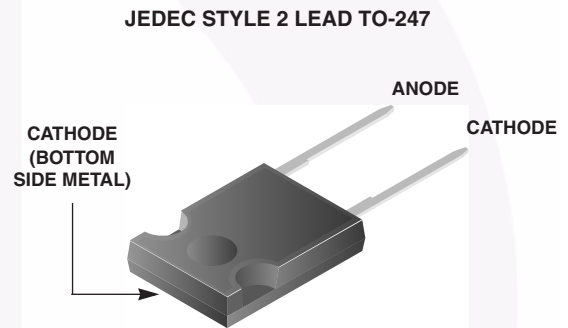

Absolute Maximum Ratings $T_C = 25^\circ\text{C}$, Unless Otherwise Specified

	RURG3060	UNIT
Peak Repetitive Reverse Voltage	V_{RRM} 600	V
Working Peak Reverse Voltage	V_{RWM} 600	V
DC Blocking Voltage	V_R 600	V
Average Rectified Forward Current	$I_{F(AV)}$ 30	A
($T_C = 130^\circ\text{C}$)		
Repetitive Peak Surge Current	I_{FRM} 70	A
(Square Wave, 20 kHz)		
Nonrepetitive Peak Surge Current	I_{FSM} 325	A
(Halfwave, 1 Phase, 60 Hz)		
Maximum Power Dissipation	P_D 125	W
Avalanche Energy (See Figures 7 and 8)	E_{AVL} 20	mJ
Operating and Storage Temperature	T_{STG}, T_J -65 to 175	$^\circ\text{C}$

Electrical Specifications $T_C = 25^\circ\text{C}$, Unless Otherwise Specified

SYMBOL	TEST CONDITION	TYP	MAX	UNIT
V_F	$I_F = 30\text{ A}$	-	1.5	V
	$I_F = 30\text{ A}, T_C = 150^\circ\text{C}$	-	1.3	V
I_R	$V_R = 600\text{ V}$	-	250	μA
	$V_R = 600\text{ V}, T_C = 150^\circ\text{C}$	-	1	mA
t_{rr}	$I_F = 1\text{ A}, dI_F/dt = 100\text{ A}/\mu\text{s}$	-	55	ns
	$I_F = 30\text{ A}, dI_F/dt = 100\text{ A}/\mu\text{s}$	-	60	ns
t_a	$I_F = 30\text{ A}, dI_F/dt = 100\text{ A}/\mu\text{s}$	30	-	ns
t_b	$I_F = 30\text{ A}, dI_F/dt = 100\text{ A}/\mu\text{s}$	20	-	ns
$R_{\theta JC}$		-	1.2	$^\circ\text{C}/\text{W}$

DEFINITIONS

V_F = Instantaneous forward voltage ($p_w = 300\ \mu\text{s}$, $D = 2\%$).

I_R = Instantaneous reverse current.

t_{rr} = Reverse recovery time (See Figure 6), summation of $t_a + t_b$.

t_a = Time to reach peak reverse current (See Figure 6).

t_b = Time from peak I_{RM} to projected zero crossing of I_{RM} based on a straight line from peak I_{RM} through 25% of I_{RM} (See Figure 6).

$R_{\theta JC}$ = Thermal resistance junction to case.

p_w = Pulse width.

D = Duty cycle.

Typical Performance Curves

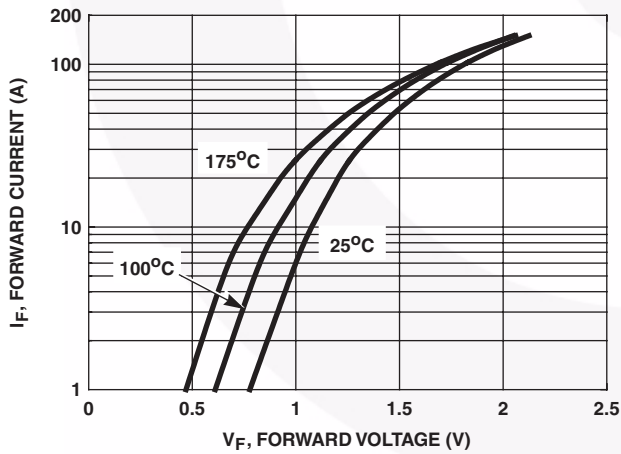

FIGURE 1. FORWARD CURRENT vs FORWARD VOLTAGE

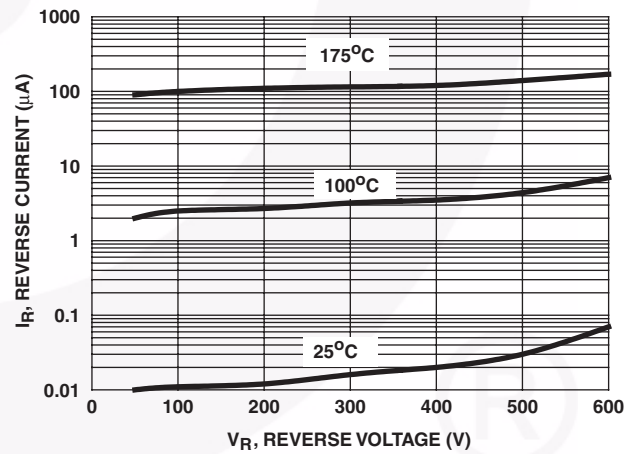

FIGURE 2. REVERSE CURRENT vs REVERSE VOLTAGE

Typical Performance Curves (Continued)

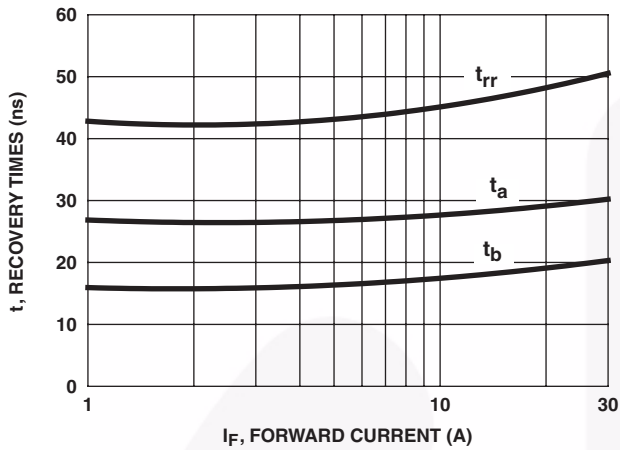

FIGURE 3. t_{rr}, t_a AND t_b CURVES vs FORWARD CURRENT

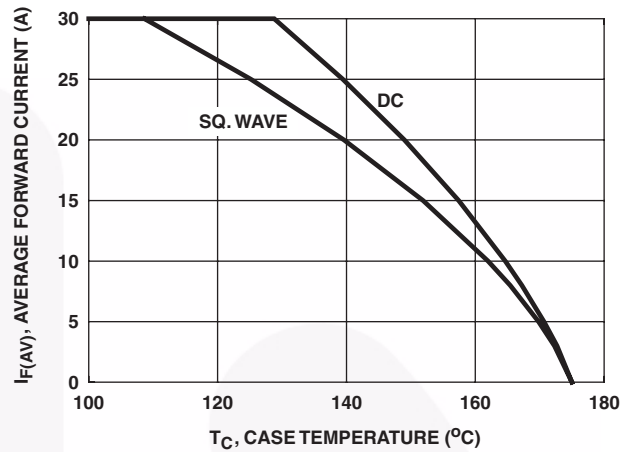

FIGURE 4. CURRENT DERATING CURVE

Test Circuits and Waveforms

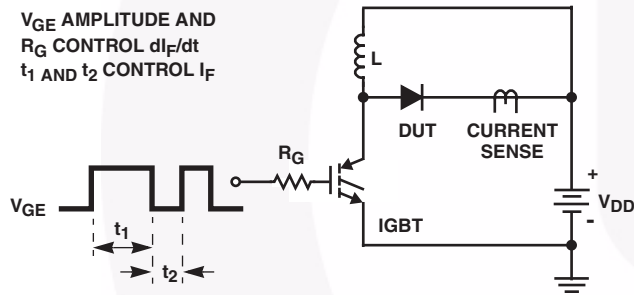

FIGURE 5. t_{rr} TEST CIRCUIT

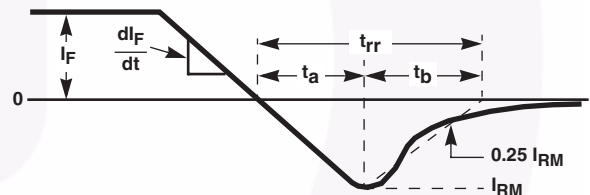

FIGURE 6. t_{rr} WAVEFORMS AND DEFINITIONS

I = 1A
 L = 40mH
 R < 0.1Ω
 $E_{AVL} = 1/2LI^2 [V_{R(AVL)}/(V_{R(AVL)} - V_{DD})]$
 Q₁ = IGBT (BV_{CES} > DUT V_{R(AVL)})

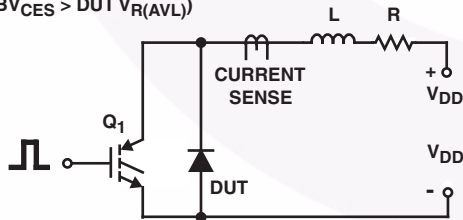

FIGURE 7. AVALANCHE ENERGY TEST CIRCUIT

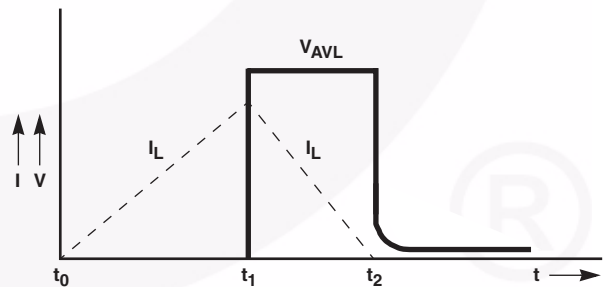

FIGURE 8. AVALANCHE CURRENT AND VOLTAGE WAVEFORMS

Mechanical Dimensions

TO247-2L

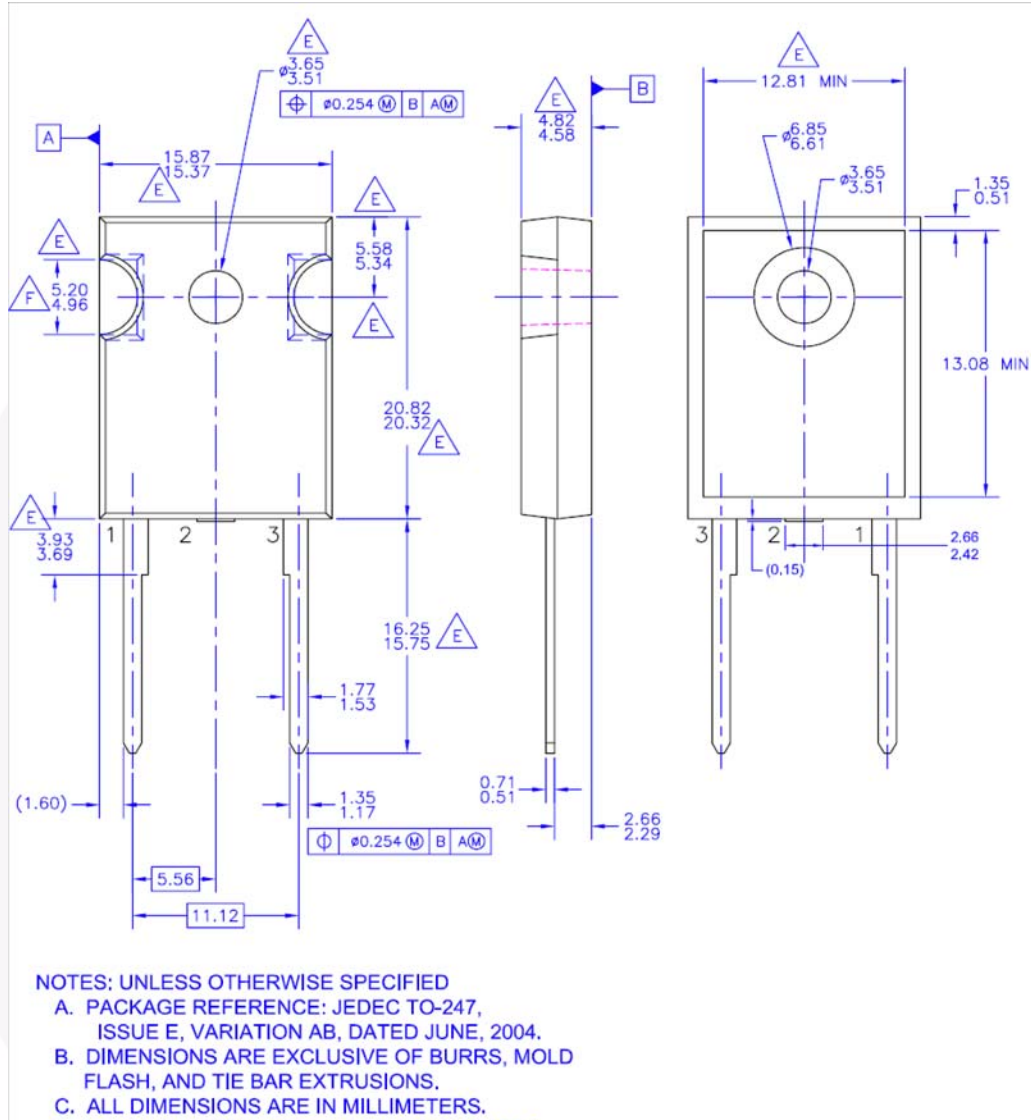

Figure 9. TO-247, Molded, 2LD, Jedec Option AB

Package drawings are provided as a service to customers considering Fairchild components. Drawings may change in any manner without notice. Please note the revision and/or date on the drawing and contact a Fairchild Semiconductor representative to verify or obtain the most recent revision. Package specifications do not expand the terms of Fairchild's worldwide terms and conditions, specifically the warranty therein, which covers Fairchild products.



Always visit Fairchild Semiconductor's online packaging area for the most recent package drawings:

http://www.fairchildsemi.com/package/packageDetails.html?id=PN_TO247-002.



TRADEMARKS

The following includes registered and unregistered trademarks and service marks, owned by Fairchild Semiconductor and/or its global subsidiaries, and is not intended to be an exhaustive list of all such trademarks.

- | | | | |
|---|---|---------------------------------------|---|
| AccuPower™ | F-PFST™ | PowerTrench® | Sync-Lock™ |
| AX-CAP®* | FRFET® | PowerXS™ | SYSTEM ®* |
| BitSiC™ | Global Power Resource SM | Programmable Active Droop™ | GENERAL |
| Build it Now™ | GreenBridge™ | QFET® | TinyBoost® |
| CorePLUS™ | Green FPS™ | QS™ | TinyBuck® |
| CorePOWER™ | Green FPS™ e-Series™ | Quiet Series™ | TinyCalc™ |
| CROSSVOLT™ | Gmax™ | RapidConfigure™ | TinyLogic® |
| CTL™ | GTO™ | Saving our world, 1mW/W/kW at a time™ | TINYOPTO™ |
| Current Transfer Logic™ | IntelliMAX™ | SignalWise™ | TinyPower™ |
| DEUXPEED® | ISOPLANAR™ | SmartMax™ | TinyPWM™ |
| Dual Cool™ | Marking Small Speakers Sound Louder and Better™ | SMART START™ | TinyWire™ |
| EcoSPARK® | MegaBuck™ | Solutions for Your Success™ | TranSiC™ |
| EfficientMax™ | MICROCOUPLER™ | SPM® | TriFault Detect™ |
| ESBC™ | MicroFET™ | STEALTH™ | TRUECURRENT®* |
|  | MicroPak™ | SuperFET® | µSerDes™ |
| Fairchild® | MicroPak2™ | SuperSOT™-3 |  |
| Fairchild Semiconductor® | MillerDrive™ | SuperSOT™-6 | UHC® |
| FACT Quiet Series™ | MotionMax™ | SuperSOT™-8 | Ultra FRFET™ |
| FACT® | mWSave® | SupreMOS® | UniFET™ |
| FAST® | OptoHit™ | SyncFET™ | VCX™ |
| FastvCore™ | OPTOLOGIC® | | VisualMax™ |
| FETBench™ | OPTOPLANAR® | | VoltagePlus™ |
| FPS™ | | | XS™ |

*Trademarks of System General Corporation, used under license by Fairchild Semiconductor.

DISCLAIMER

FAIRCHILD SEMICONDUCTOR RESERVES THE RIGHT TO MAKE CHANGES WITHOUT FURTHER NOTICE TO ANY PRODUCTS HEREIN TO IMPROVE RELIABILITY, FUNCTION, OR DESIGN. FAIRCHILD DOES NOT ASSUME ANY LIABILITY ARISING OUT OF THE APPLICATION OR USE OF ANY PRODUCT OR CIRCUIT DESCRIBED HEREIN; NEITHER DOES IT CONVEY ANY LICENSE UNDER ITS PATENT RIGHTS, NOR THE RIGHTS OF OTHERS. THESE SPECIFICATIONS DO NOT EXPAND THE TERMS OF FAIRCHILD'S WORLDWIDE TERMS AND CONDITIONS, SPECIFICALLY THE WARRANTY THEREIN, WHICH COVERS THESE PRODUCTS.

LIFE SUPPORT POLICY

FAIRCHILD'S PRODUCTS ARE NOT AUTHORIZED FOR USE AS CRITICAL COMPONENTS IN LIFE SUPPORT DEVICES OR SYSTEMS WITHOUT THE EXPRESS WRITTEN APPROVAL OF FAIRCHILD SEMICONDUCTOR CORPORATION.

As used here in:

- Life support devices or systems are devices or systems which, (a) are intended for surgical implant into the body or (b) support or sustain life, and (c) whose failure to perform when properly used in accordance with instructions for use provided in the labeling, can be reasonably expected to result in a significant injury of the user.
- A critical component in any component of a life support, device, or system whose failure to perform can be reasonably expected to cause the failure of the life support device or system, or to affect its safety or effectiveness.

ANTI-COUNTERFEITING POLICY

Fairchild Semiconductor Corporation's Anti-Counterfeiting Policy. Fairchild's Anti-Counterfeiting Policy is also stated on our external website, www.fairchildsemi.com, under Sales Support. Counterfeiting of semiconductor parts is a growing problem in the industry. All manufactures of semiconductor products are experiencing counterfeiting of their parts. Customers who inadvertently purchase counterfeit parts experience many problems such as loss of brand reputation, substandard performance, failed application, and increased cost of production and manufacturing delays. Fairchild is taking strong measures to protect ourselves and our customers from the proliferation of counterfeit parts. Fairchild strongly encourages customers to purchase Fairchild parts either directly from Fairchild or from Authorized Fairchild Distributors who are listed by country on our web page cited above. Products customers buy either from Fairchild directly or from Authorized Fairchild Distributors are genuine parts, have full traceability, meet Fairchild's quality standards for handling and storage and provide access to Fairchild's full range of up-to-date technical and product information. Fairchild and our Authorized Distributors will stand behind all warranties and will appropriately address and warranty issues that may arise. Fairchild will not provide any warranty coverage or other assistance for parts bought from Unauthorized Sources. Fairchild is committed to combat this global problem and encourage our customers to do their part in stopping this practice by buying direct or from authorized distributors.

PRODUCT STATUS DEFINITIONS
Definition of Terms

Datasheet Identification	Product Status	Definition
Advance Information	Formative / In Design	Datasheet contains the design specifications for product development. Specifications may change in any manner without notice.
Preliminary	First Production	Datasheet contains preliminary data; supplementary data will be published at a later date. Fairchild Semiconductor reserves the right to make changes at any time without notice to improve design.
No Identification Needed	Full Production	Datasheet contains final specifications. Fairchild Semiconductor reserves the right to make changes at any time without notice to improve the design.
Obsolete	Not In Production	Datasheet contains specifications on a product that is discontinued by Fairchild Semiconductor. The datasheet is for reference information only.

Rev. 166