

International
Power Sources, Inc.

221

orig

005751

5751

IPR

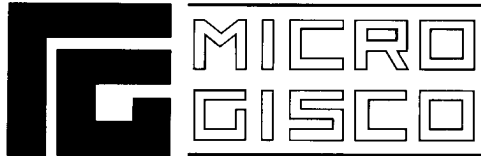

- Regulated and Non Regulated Outputs
- Inputs 5 and 12 VDC
- Outputs (Floating) 5, 12, 15, ± 12 , ± 15 VDC
- Standard Industry Pinout
- Optional Input Filter

Description

International Power Sources, Inc. brings to the United States the Micro Gisco 2CCN/R Series of Regulated and Unregulated DC/DC converters. This family of devices utilizes thick film hybrid technology to provide up to 2 watts in the package pinout which has become the industry standard. The 2CCN/R series consists of regulated and unregulated units in five different output models in two input ranges. Foldback short circuit protection is standard on all regulated models along with a current limiting circuit in unregulated units.

On special request, other input and output models are available for large volume applications.

Environmental Specifications

Temperature Range -25 to $+70^\circ\text{C}$
 Storage Temperature -50 to $+125^\circ\text{C}$
 Damp Heat Test 56 days 40°C 95% rh
 Weight 12 g
 I/O Isolation 500 VDC

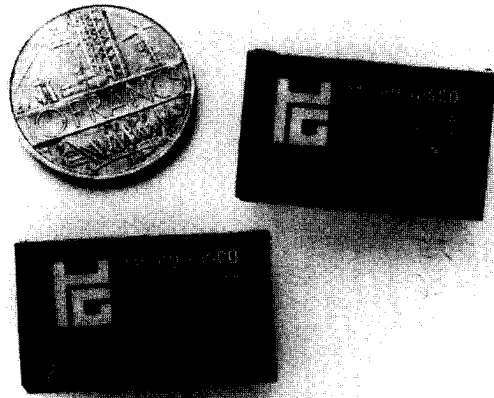

Miniature Hybrid 1-2 Watt DC/DC Converters 2CCR/2CCN Series

Electrical Specifications

Typical @ $+25^\circ\text{C}$ after warm up.

Input voltage V_{IN}		5V	12V
Input voltage range	Regulated	$\pm 5\%$	$\pm 10\%$
	Unregulated	$\pm 10\%$	$\pm 10\%$
Input overvoltage (volts)		12	22
Max. input current (A)	Regulated (foldback)	0.7	0.3
	Unregulated (power limits)	0.3	0.12
Short circuit protection		Regulated 150% Unregulated 150-200%	150-200%
Regulation			
Line/Load (20% to 100%)	Regulated	1%	0.5%
	Unregulated	$1\%/ \Delta V_{IN}$	$1\%/ \Delta V_{IN}$
Load (50% to 100%)		Unregulated -0 to +20%	-0 to +20%
Input reflected noise (mV pp)		150	150
Output voltage V_{OUT}		$\pm 5\%$	$\pm 5\%$
Output ripple and noise (mV pp)	Regulated	50	50
	Unregulated	80	80

Specifications subject to change without notice.

Block Diagram

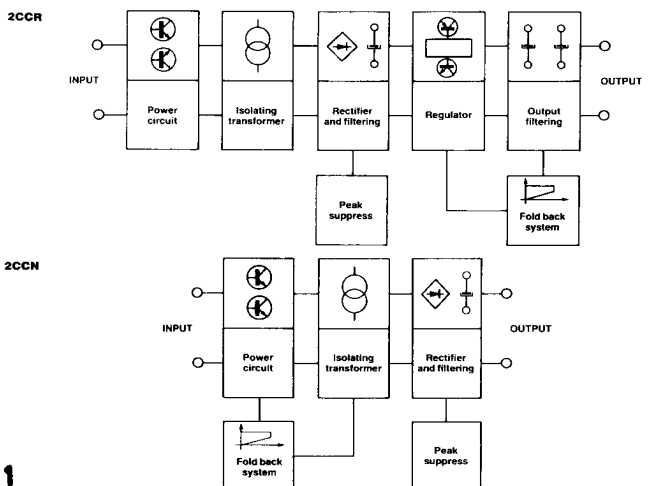

Ordering Guide

	MODEL	V _{IN}	V _{OUT} /I _{OUT}	POWER	PACKAGE*	PRICE (1-24)
Unregulated	2CCN 0505 S	5V	5V/200mA	1.0W	A	\$28.75
	2CCN 0512 S	5V	12V/80mA	1.0W	A	\$28.75
	2CCN 0515 S	5V	15V/65mA	1.0W	A	\$28.75
	2CCN 1205 S	12V	5V/200mA	1.0W	A	\$28.75
	2CCN 1212 S	12V	12V/80mA	1.0W	A	\$28.75
	2CCN 1215 S	12V	15V/65mA	1.0W	A	\$28.75
	2CCN 0512 D	5V	± 12V/± 40mA	1.0W	C	\$28.75
	2CCN 0515 D	5V	± 15V/± 33mA	1.0W	C	\$28.75
	2CCN 1212 D	12V	± 12V/± 40mA	1.0W	C	\$28.75
	2CCN 1215 D	12V	± 15V/± 33mA	1.0W	C	\$28.75
Regulated	2CCR 0505 S	5V	+ 5V/100mA	0.5W	A/X	\$35.00
	2CCR 0512 S	5V	+ 12V/100mA	1.2W	A/X	\$35.00
	2CCR 0515 S	5V	+ 15V/100mA	1.5W	A/X	\$35.00
	2CCR 1205 S	12V	+ 5V/100mA	0.5W	A/X	\$35.00
	2CCR 1212 S	12V	+ 12V/100mA	1.2W	A/X	\$35.00
	2CCR 1215 S	12V	+ 15V/100mA	1.5W	A/X	\$35.00
	2CCR 0512 D	5V	± 12V/± 80mA	2.0W	B/X	\$35.00
	2CCR 0515 D	5V	± 15V/± 65mA	2.0W	B/X	\$35.00
	2CCR 1212 D	12V	± 12V/± 80mA	2.0W	B/X	\$35.00
	2CCR 1215 D	12V	± 15V/± 65mA	2.0W	B/X	\$35.00

Other models available upon request.
 *Regulated versions also available in 12 pin X package. Specify X after model number.

Dimensions and Pinout (m/m) inches

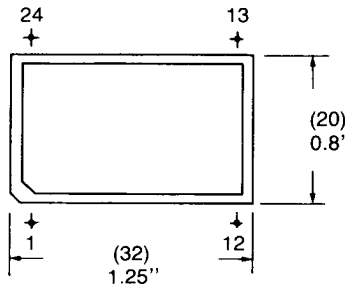
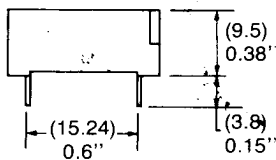
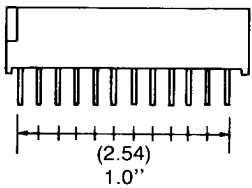

X PACKAGE		
PIN	SINGLE OUTPUT	DUAL OUTPUT
1	+V INPUT	+V INPUT
2	NC*	-V ₂ OUTPUT
3	NC*	COMMON
10	-V OUTPUT	COMMON
11	+V OUTPUT	+V OUTPUT
12	-V INPUT	-V INPUT
13	-V INPUT	-V INPUT
14	+V OUTPUT	+V ₂ OUTPUT
15	-V OUTPUT	COMMON
22	NC*	COMMON
23	NC*	-V ₂ OUTPUT
24	+V INPUT	+V INPUT

*DO NOT CONNECT

TOP VIEW

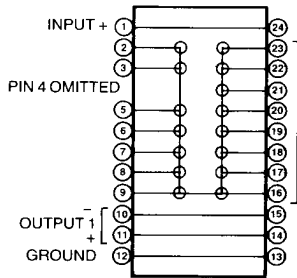

A

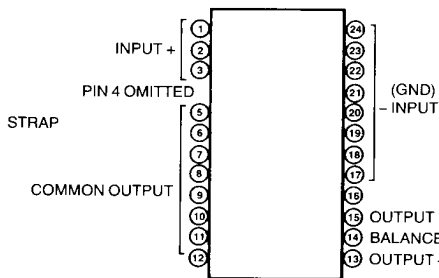

B

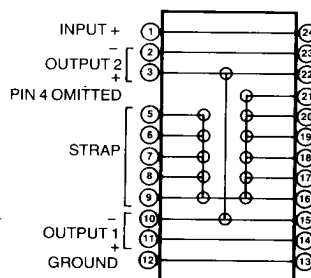

C

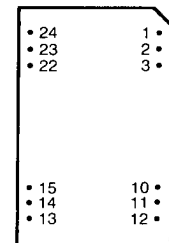

International Power Sources, Inc.
 10 Cochituate Street
 Natick, MA 01760
 Telephone: (617) 651-1818
 TWX: 5101003630 FAX: (617) 655-7984