

SHINDENGEN

Super Fast Recovery Rectifiers

Single

D1NL20U

200V 1A

FEATURES

- Low noise
- trr35ns
- 5 mm pitch mounting applicable

APPLICATION

- Switching power supply
- Free Wheel
- Home Appliances, Office Equipment
- Telecommunication, Factory Automation

OUTLINE DIMENSIONS

Case : AX057

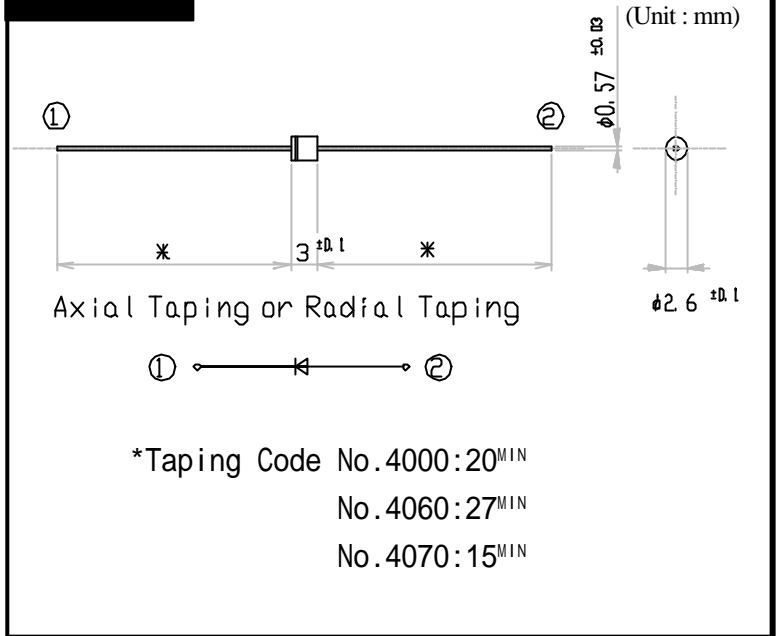

RATINGS

Absolute Maximum Ratings (If not specified Tl=25)

Item	Symbol	Conditions	Ratings	Unit
Storage Temperature	Tstg		-55 ~ 150	
Operating Junction Temperature	Tj		150	
Maximum Reverse Voltage	V _{RM}		200	V
Average Rectified Forward Current	I _O	50Hz sine wave, R-load, Ta=25	1	A
Peak Surge Forward Current	I _{FSM}	50Hz sine wave, Non-repetitive 1 cycle peak value, Tj=25	25	A

Electrical Characteristics (If not specified Tl=25)

Item	Symbol	Conditions	Ratings	Unit
Forward Voltage	V _F	I _F =1A, Pulse measurement	Max.0.98	V
Reverse Current	I _R	V _R =V _{RM} , Pulse measurement	Max.10	μA
Reverse Recovery Time	trr	I _F =0.5A, I _R =1A	Max.35	ns
Thermal Resistance	jl	junction to lead	Max.10	/W
	ja	junction to ambient, On P.C.B. Lead length=5mm	Max.113	

D1NL20U

Forward Voltage

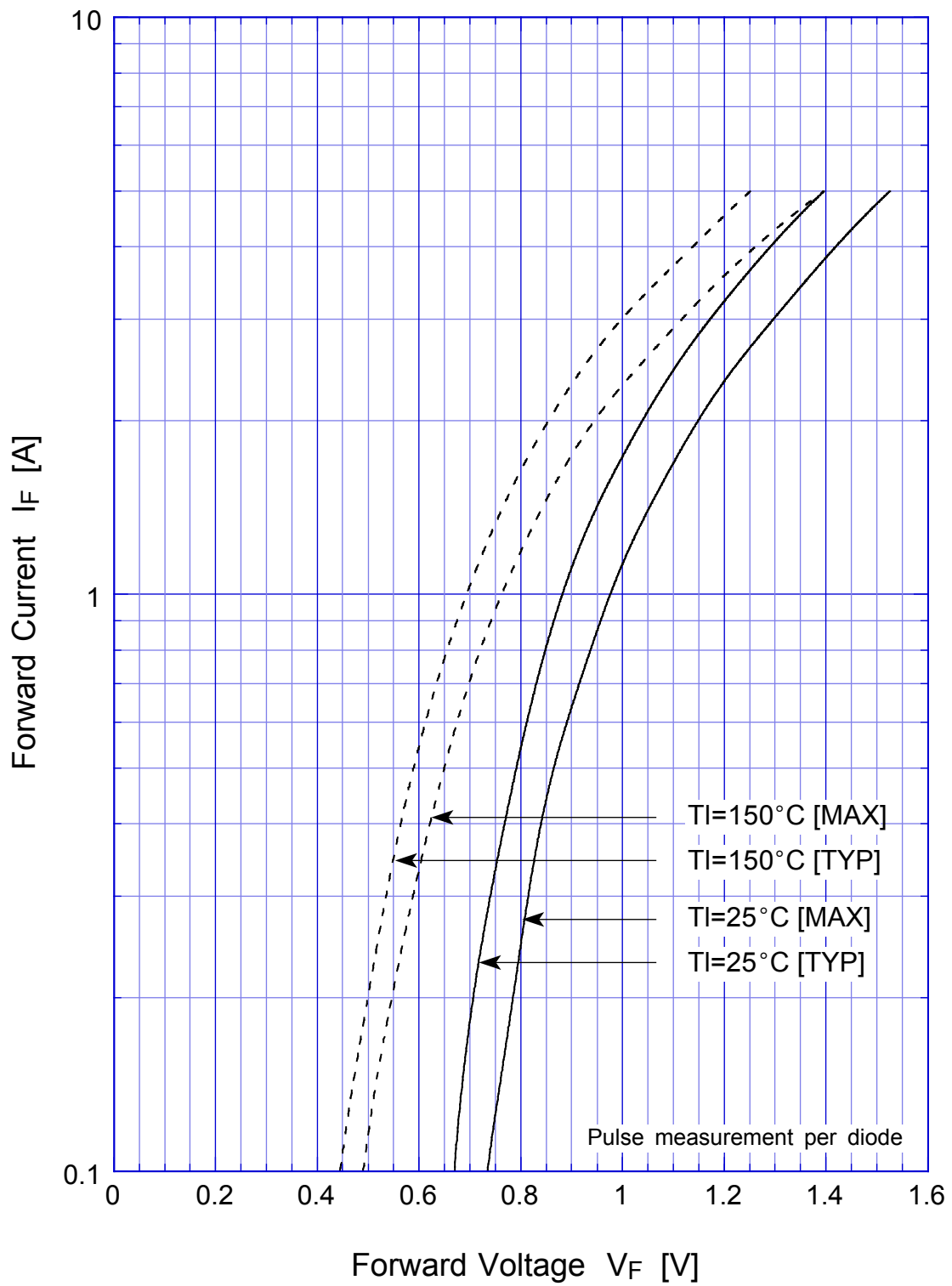

D1NL20U Forward Power Dissipation

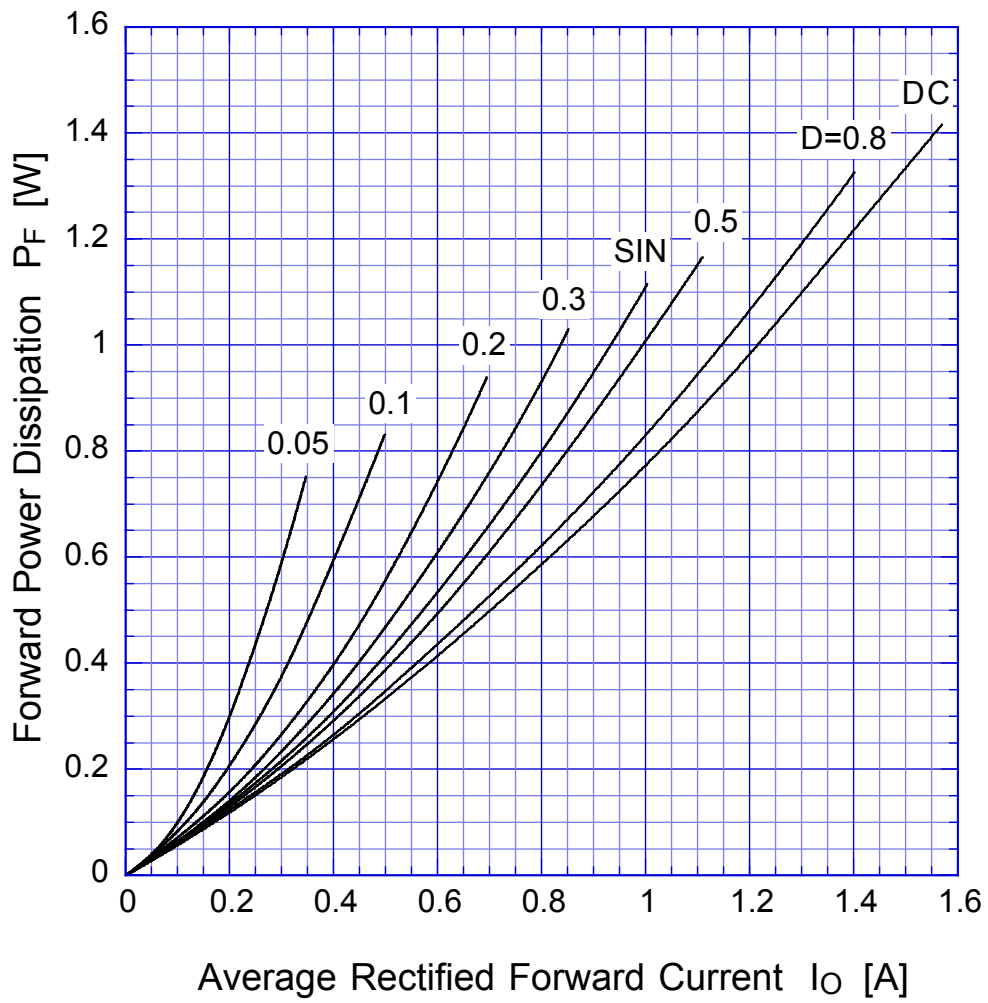

$T_j = 150^\circ\text{C}$

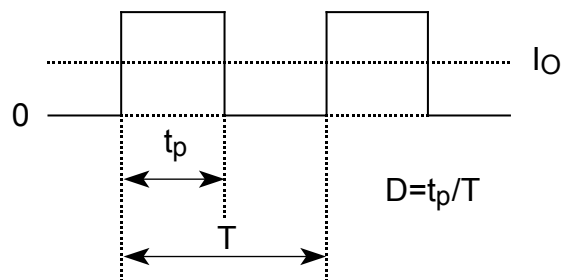

D1NL20U

Derating Curve

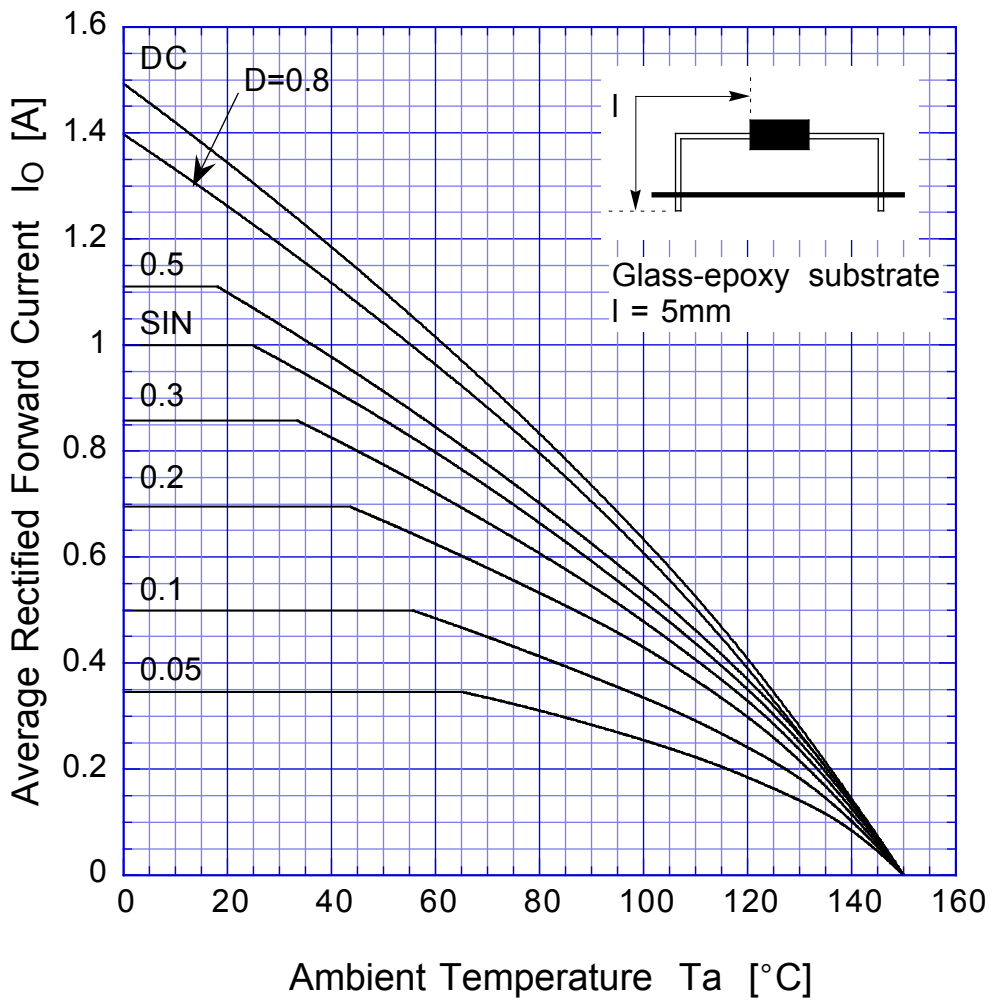

$V_R = 200\text{V}$

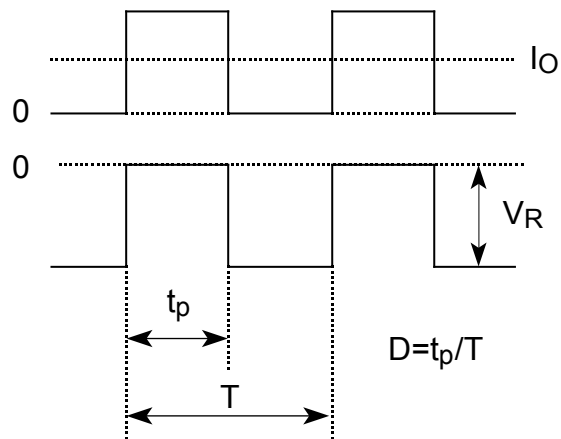

D1NL20U Peak Surge Forward Capability

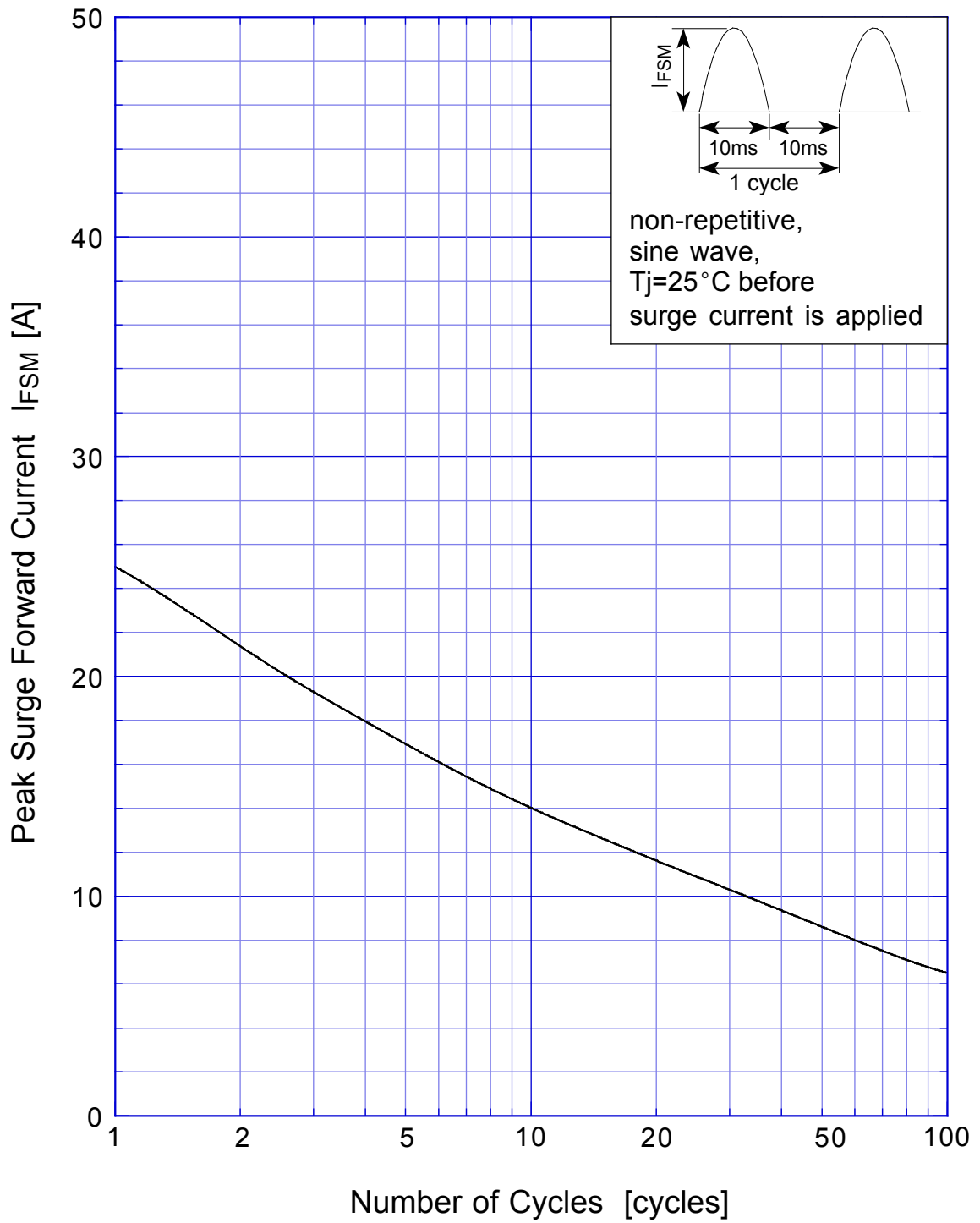

D1NL20U Junction Capacitance

