

Silicon NPN Epitaxial Planar Transistor (Complement to type 2SA1294)

Application : Audio and General Purpose

**Absolute maximum ratings** (Ta=25°C)

Symbol	Ratings	Unit
VcBO	230	V
VCEO	230	V
VEBO	5	V
Ic	15	A
IB	4	A
Pc	130(Tc=25°C)	W
Tj	150	°C
Tstg	-55 to +150	°C

**Electrical Characteristics** (Ta=25°C)

Symbol	Conditions	Ratings	Unit
IcBO	VcB=230V	100max	μA
IEBO	VEB=5V	100max	μA
V(BR)CEO	Ic=25mA	230min	V
hFE	VCE=4V, Ic=5A	50min*	
VCE(sat)	Ic=5A, IB=0.5A	2.0max	V
fT	VCE=12V, IE=-2A	60typ	MHz
COB	VcB=10V, f=1MHz	250typ	pF

\*hFE Rank  $\bar{O}$ (50 to 100), Y(70 to 140)

**Typical Switching Characteristics (Common Emitter)**

Vcc (V)	RL (Ω)	Ic (A)	VBB1 (V)	VBB2 (V)	IB1 (mA)	IB2 (mA)	ton (μs)	tstg (μs)	tf (μs)
60	12	5	10	-5	500	-500	0.30typ	2.40typ	0.50typ

**External Dimensions MT-100(TO3P)**

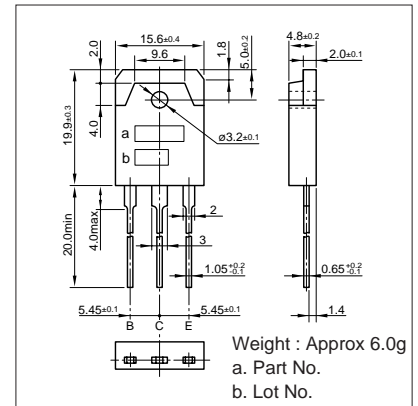

**Ic-VCE Characteristics (Typical)**

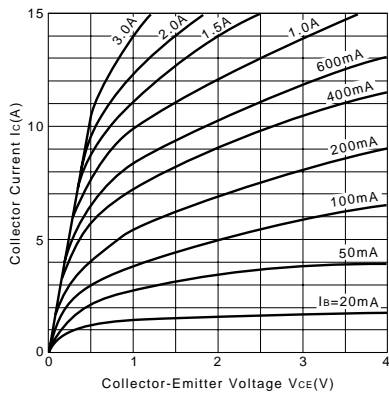

**VCE(sat)-IB Characteristics (Typical)**

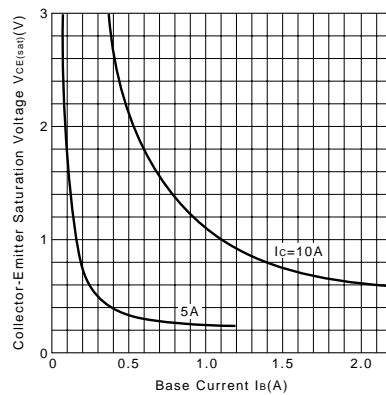

**Ic-VBE Temperature Characteristics (Typical)**

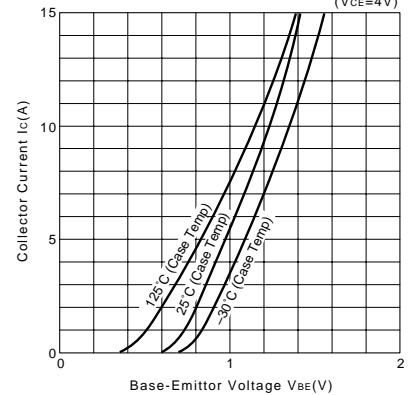

**hFE-Ic Characteristics (Typical)**

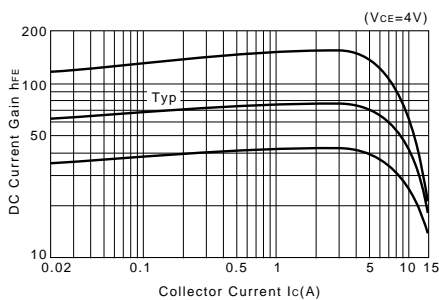

**hFE-Ic Temperature Characteristics (Typical)**

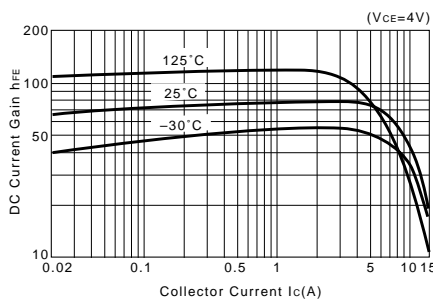

**θj-a-t Characteristics**

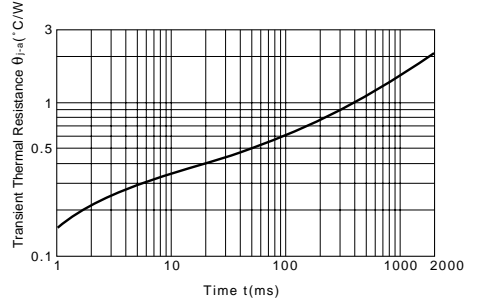

**fT-IE Characteristics (Typical)**

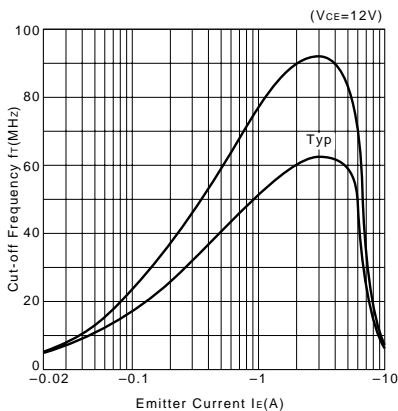

**Safe Operating Area (Single Pulse)**

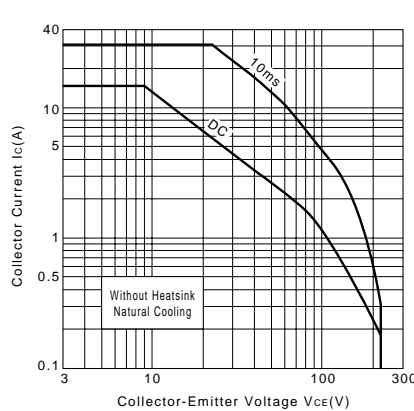

**Pc-Ta Derating**

