

International
IR Rectifier

10TQ...
 10TQ...S

SCHOTTKY RECTIFIER

10 Amp

$I_{F(AV)} = 10\text{Amp}$
 $V_R = 35 \text{ to } 45\text{V}$

Major Ratings and Characteristics



Characteristics	10TQ	Units
$I_{F(AV)}$ Rectangular waveform	10	A
V_{RRM}	35 to 45	V
I_{FSM} @ $t_p = 5\ \mu\text{s}$ sine	1050	A
V_F @10 Apk, $T_J = 125^\circ\text{C}$	0.49	V
T_J range	-55 to 175	$^\circ\text{C}$

Description/ Features

The 10TQ.. Schottky rectifier series has been optimized for low reverse leakage at high temperature. The proprietary barrier technology allows for reliable operation up to 175°C junction temperature. Typical applications are in switching power supplies, converters, free-wheeling diodes, and reverse battery protection.

- 175°C T_J operation
- High purity, high temperature epoxy encapsulation for enhanced mechanical strength and moisture resistance
- Low forward voltage drop
- High frequency operation
- Guard ring for enhanced ruggedness and long term reliability

Case Styles

10TQ...	10TQ... S
 <p>TO-220</p>	 <p>D²PAK</p>

Voltage Ratings

Part number	10TQ035	10TQ040	10TQ045
V_R Max. DC Reverse Voltage (V)	35	40	45
V_{RWM} Max. Working Peak Reverse Voltage (V)			

Absolute Maximum Ratings

Parameters	10TQ	Units	Conditions
$I_{F(AV)}$ Max. Average Forward Current * See Fig. 5	10	A	50% duty cycle @ $T_C = 151^\circ\text{C}$, rectangular wave form
I_{FSM} Max. Peak One Cycle Non-Repetitive Surge Current * See Fig. 7	1050	A	Following any rated load condition and with rated V_{RRM} applied
	280		
E_{AS} Non-Repetitive Avalanche Energy	13	mJ	$T_J = 25^\circ\text{C}$, $I_{AS} = 2\text{Amps}$, $L = 6.5\text{mH}$
I_{AR} Repetitive Avalanche Current	2	A	Current decaying linearly to zero in 1 μsec Frequency limited by T_J max. $V_A = 1.5 \times V_R$ typical

Electrical Specifications

Parameters	10TQ	Units	Conditions
V_{FM} Max. Forward Voltage Drop (1) * See Fig. 1	0.57	V	@ 10A $T_J = 25^\circ\text{C}$
	0.67	V	@ 20A
	0.49	V	@ 10A $T_J = 125^\circ\text{C}$
	0.61	V	@ 20A
I_{RM} Max. Reverse Leakage Current (1) * See Fig. 2	2	mA	$T_J = 25^\circ\text{C}$
	15	mA	$T_J = 125^\circ\text{C}$ $V_R = \text{rated } V_R$
C_T Max. Junction Capacitance	900	pF	$V_R = 5V_{DC}$, (test signal range 100Khz to 1Mhz) 25°C
L_S Typical Series Inductance	8.0	nH	Measured lead to lead 5mm from package body
dv/dt Max. Voltage Rate of Change (Rated V_R)	10,000	V/ μs	

(1) Pulse Width < 300 μs , Duty Cycle < 2%

Thermal-Mechanical Specifications

Parameters	10TQ	Units	Conditions
T_J Max. Junction Temperature Range	-55 to 175	$^\circ\text{C}$	
T_{stg} Max. Storage Temperature Range	-55 to 175	$^\circ\text{C}$	
R_{thJC} Max. Thermal Resistance Junction to Case	2.0	$^\circ\text{C/W}$	DC operation * See Fig. 4
R_{thCS} Typical Thermal Resistance, Case to Heatsink	0.50	$^\circ\text{C/W}$	Mounting surface, smooth and greased
wt Approximate Weight	2 (0.07)	g (oz.)	
T Mounting Torque	Min.	6 (5)	Kg-cm (lbf-in)
	Max.	12 (10)	

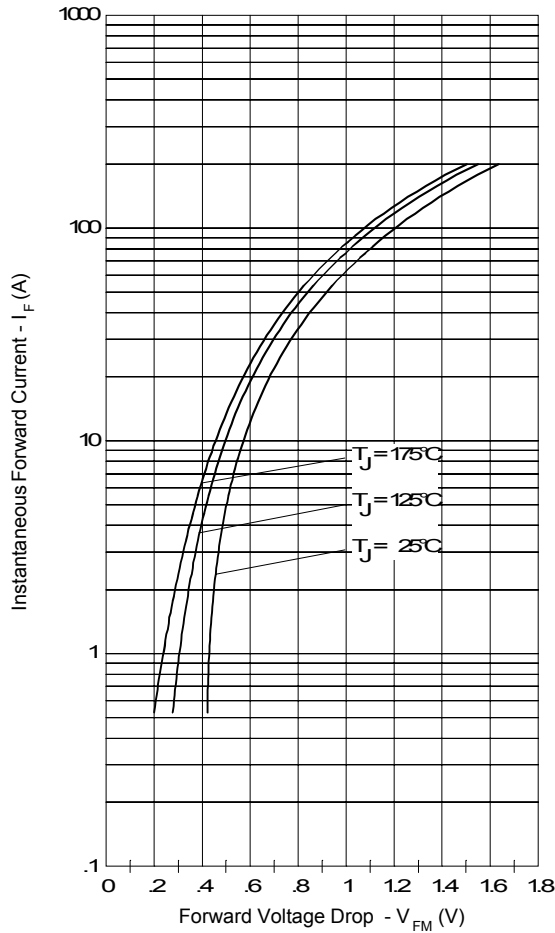

Fig. 1 - Maximum Forward Voltage Drop Characteristics

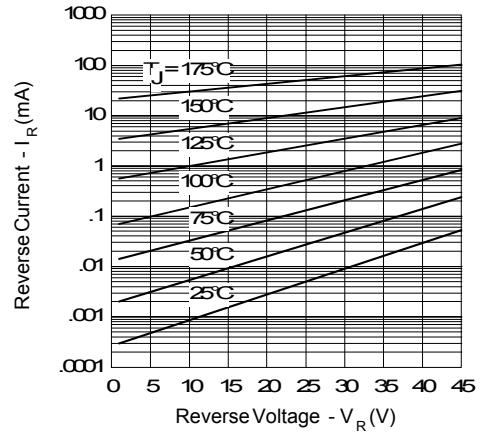

Fig. 2 - Typical Values of Reverse Current Vs. Reverse Voltage

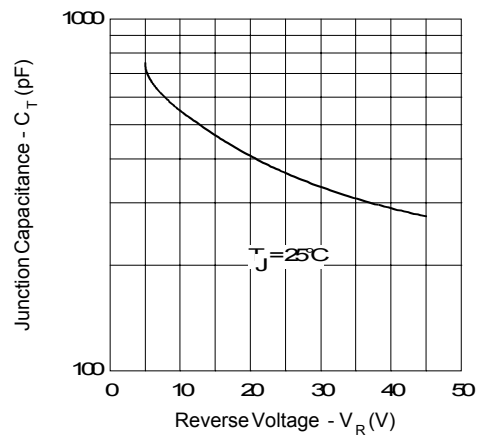

Fig. 3 - Typical Junction Capacitance Vs. Reverse Voltage

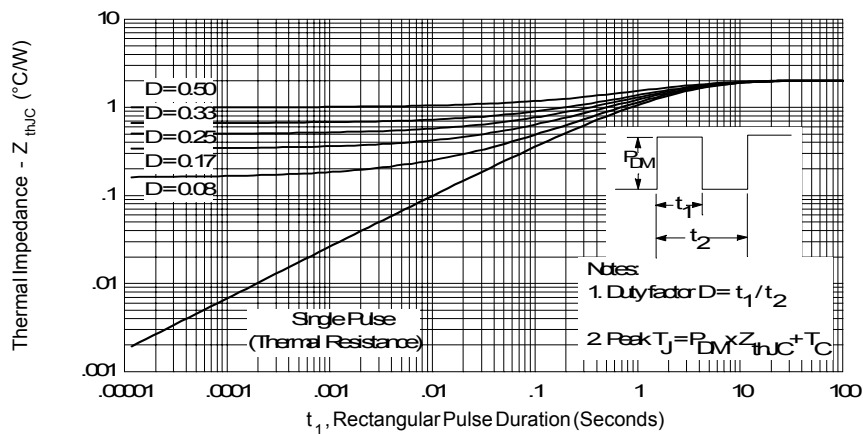

Fig. 4 - Maximum Thermal Impedance Z_{thJC} Characteristics

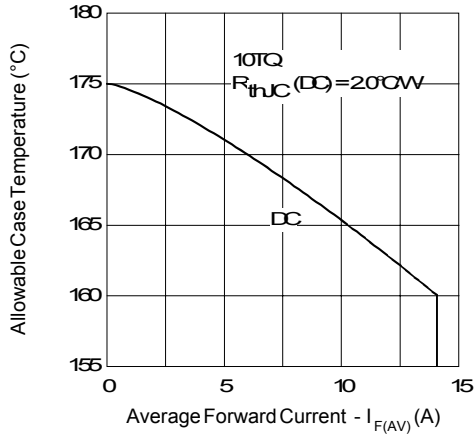

Fig. 5 - Maximum Allowable Case Temperature Vs. Average Forward Current

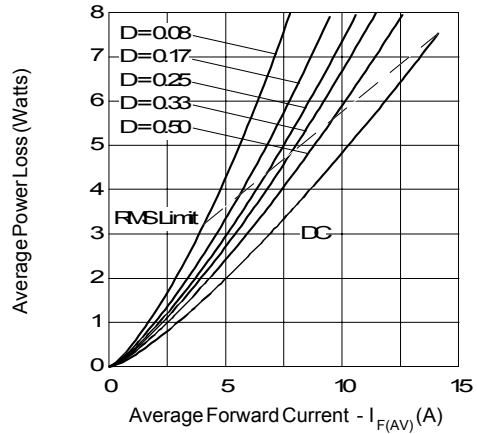

Fig. 6 - Forward Power Loss Characteristics

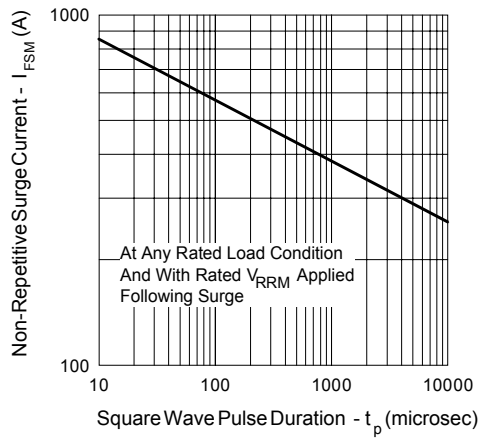

Fig. 7 - Maximum Non-Repetitive Surge Current

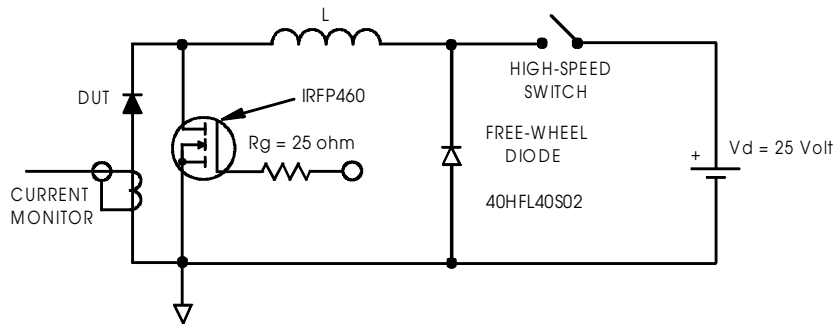
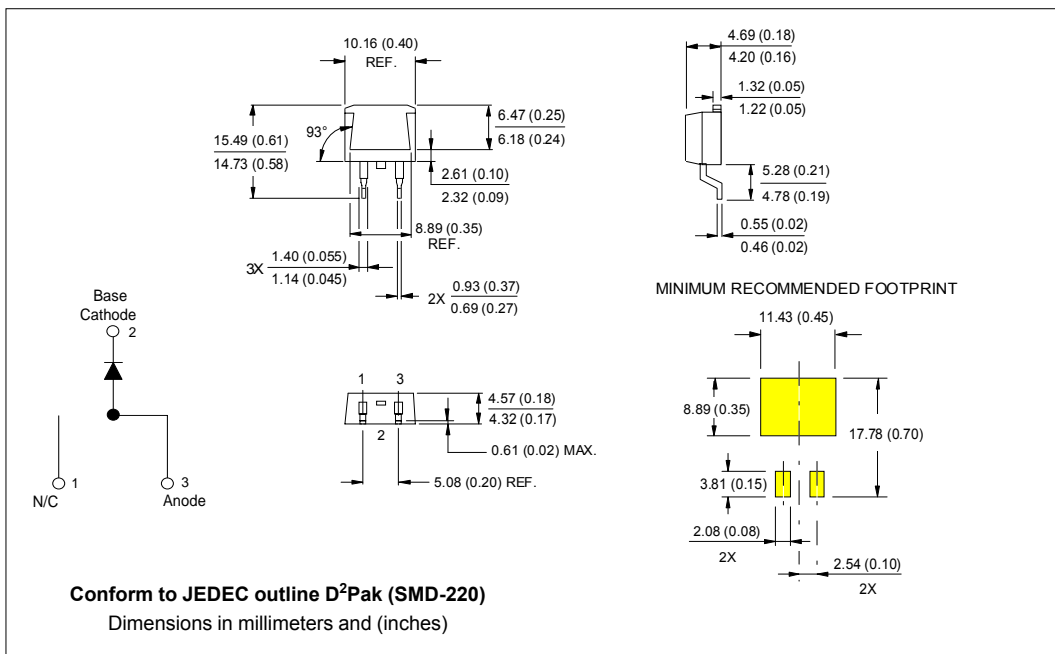
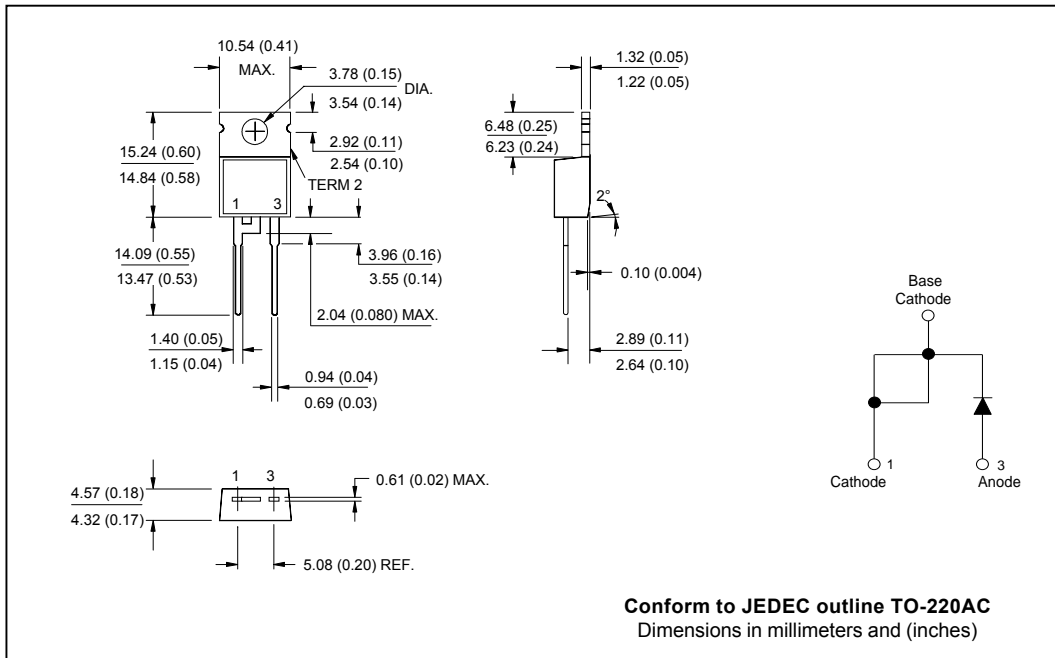
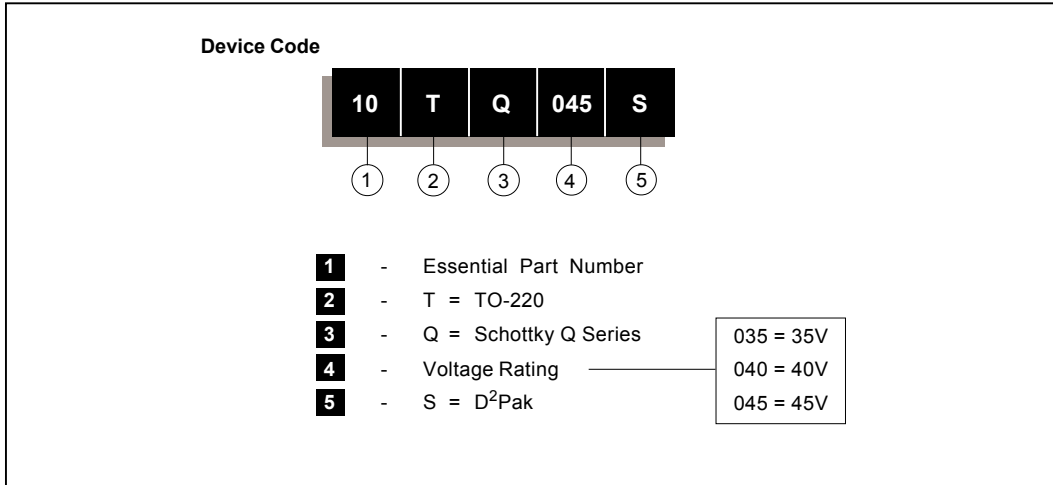

Fig. 8 - Unclamped Inductive Test Circuit

Outline Table



Ordering Information Table



This datasheet has been download from:

www.datasheetcatalog.com

Datasheets for electronics components.