

**Triacs**

**BT138 series**

**GENERAL DESCRIPTION**

Glass passivated triacs in a plastic envelope, intended for use in applications requiring high bidirectional transient and blocking voltage capability and high thermal cycling performance. Typical applications include motor control, industrial and domestic lighting, heating and static switching.

**QUICK REFERENCE DATA**

SYMBOL	PARAMETER	MAX.	MAX.	MAX.	UNIT
$V_{DRM}$	Repetitive peak off-state voltages	BT138-500	600	800	V
		BT138-500F	600F	800F	
		BT138-500G	600G	800G	
$I_{T(RMS)}$	RMS on-state current	12	12	12	A
$I_{TSM}$	Non-repetitive peak on-state current	95	95	95	A

**PINNING - TO220AB**

PIN	DESCRIPTION
1	main terminal 1
2	main terminal 2
3	gate
tab	main terminal 2

**PIN CONFIGURATION**

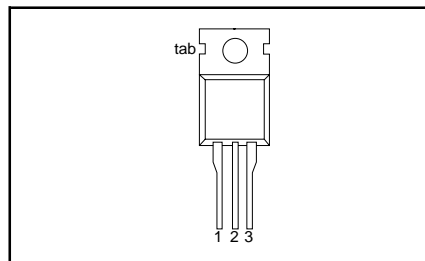

**SYMBOL**



**LIMITING VALUES**

Limiting values in accordance with the Absolute Maximum System (IEC 134).

SYMBOL	PARAMETER	CONDITIONS	MIN.	MAX.			UNIT
				-500	-600	-800	
$V_{DRM}$	Repetitive peak off-state voltages		-	500 <sup>1</sup>	600 <sup>1</sup>	800	V
$I_{T(RMS)}$	RMS on-state current	full sine wave; $T_{mb} \leq 99\text{ }^\circ\text{C}$	-	12			A
$I_{TSM}$	Non-repetitive peak on-state current	full sine wave; $T_j = 25\text{ }^\circ\text{C}$ prior to surge	-	95			A
$I^2t$	$I^2t$ for fusing	$t = 20\text{ ms}$	-	105			A
$di_T/dt$	Repetitive rate of rise of on-state current after triggering	$t = 16.7\text{ ms}$	-	45			A <sup>2</sup> s
		$t = 10\text{ ms}$	-	10			A <sup>2</sup> s
		$I_{TM} = 20\text{ A}; I_G = 0.2\text{ A}; di_G/dt = 0.2\text{ A}/\mu\text{s}$	-	50			A/ $\mu\text{s}$
		T2+ G+	-	50			A/ $\mu\text{s}$
		T2+ G-	-	50			A/ $\mu\text{s}$
		T2- G-	-	10			A/ $\mu\text{s}$
		T2- G+	-	2			A
$I_{GM}$	Peak gate current		-	5			V
$V_{GM}$	Peak gate voltage		-	5			W
$P_{GM}$	Peak gate power		-	0.5			W
$P_{G(AV)}$	Average gate power	over any 20 ms period	-	150			$^\circ\text{C}$
$T_{stg}$	Storage temperature		-40	125			$^\circ\text{C}$
$T_j$	Operating junction temperature		-				$^\circ\text{C}$

<sup>1</sup> Although not recommended, off-state voltages up to 800V may be applied without damage, but the triac may switch to the on-state. The rate of rise of current should not exceed 15 A/ $\mu\text{s}$ .

## Triacs

## BT138 series

## THERMAL RESISTANCES

SYMBOL	PARAMETER	CONDITIONS	MIN.	TYP.	MAX.	UNIT
$R_{th\ j-mb}$	Thermal resistance junction to mounting base	full cycle	-	-	1.5	K/W
$R_{th\ j-a}$	Thermal resistance junction to ambient	half cycle in free air	-	-	2.0	K/W
			-	60	-	K/W

## STATIC CHARACTERISTICS

 $T_j = 25\text{ }^\circ\text{C}$  unless otherwise stated

SYMBOL	PARAMETER	CONDITIONS	MIN.	TYP.	MAX.			UNIT
$I_{GT}$	Gate trigger current	<b>BT138-</b> $V_D = 12\text{ V}; I_T = 0.1\text{ A}$	-	-	...	...F	...G	
		T2+ G+	-	5	35	25	50	mA
		T2+ G-	-	8	35	25	50	mA
		T2- G-	-	10	35	25	50	mA
		T2- G+	-	22	70	70	100	mA
$I_L$	Latching current	$V_D = 12\text{ V}; I_{GT} = 0.1\text{ A}$	-	-	-	-	-	
		T2+ G+	-	7	40	40	60	mA
		T2+ G-	-	20	60	60	90	mA
		T2- G-	-	8	40	40	60	mA
		T2- G+	-	10	60	60	90	mA
$I_H$	Holding current	$V_D = 12\text{ V}; I_{GT} = 0.1\text{ A}$	-	6	30	30	60	mA
$V_T$	On-state voltage	$I_T = 15\text{ A}$	-	1.4	1.65			V
$V_{GT}$	Gate trigger voltage	$V_D = 12\text{ V}; I_T = 0.1\text{ A}$	-	0.7	1.5			V
		$V_D = 400\text{ V}; I_T = 0.1\text{ A};$ $T_j = 125\text{ }^\circ\text{C}$	0.25	0.4	-			V
$I_D$	Off-state leakage current	$V_D = V_{DRM(max)};$ $T_j = 125\text{ }^\circ\text{C}$	-	0.1	0.5			mA

## DYNAMIC CHARACTERISTICS

 $T_j = 25\text{ }^\circ\text{C}$  unless otherwise stated

SYMBOL	PARAMETER	CONDITIONS	MIN.			TYP.	MAX.	UNIT
$dV_D/dt$	Critical rate of rise of off-state voltage	<b>BT138-</b> $V_{DM} = 67\% V_{DRM(max)};$ $T_j = 125\text{ }^\circ\text{C};$ exponential waveform; gate open circuit	...	...F	...G	250	-	V/ $\mu\text{s}$
$dV_{com}/dt$	Critical rate of change of commutating voltage	$V_{DM} = 400\text{ V}; T_j = 95\text{ }^\circ\text{C};$ $I_{T(RMS)} = 12\text{ A};$ $dl_{com}/dt = 5.4\text{ A/ms};$ gate open circuit	-	-	10	20	-	V/ $\mu\text{s}$
$t_{gt}$	Gate controlled turn-on time	$I_{TM} = 16\text{ A}; V_D = V_{DRM(max)};$ $I_G = 0.1\text{ A}; dl_G/dt = 5\text{ A}/\mu\text{s}$	-	-	-	2	-	$\mu\text{s}$

Triacs

BT138 series

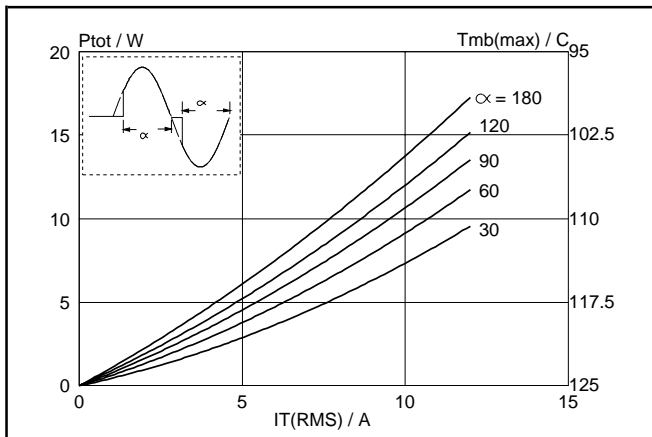

Fig.1. Maximum on-state dissipation,  $P_{tot}$ , versus rms on-state current,  $I_{T(RMS)}$ , where  $\alpha$  = conduction angle.

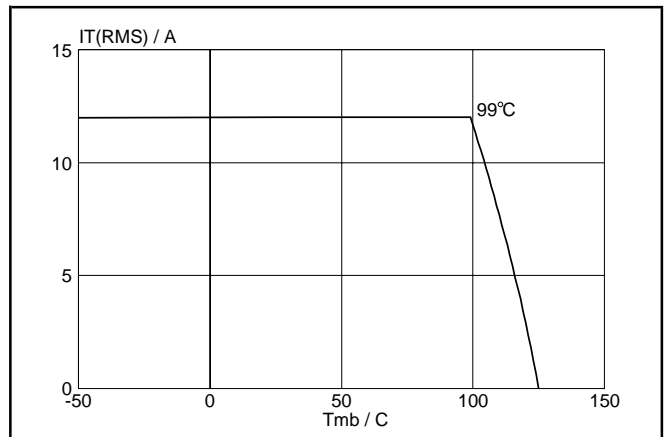

Fig.4. Maximum permissible rms current  $I_{T(RMS)}$ , versus mounting base temperature  $T_{mb}$ .

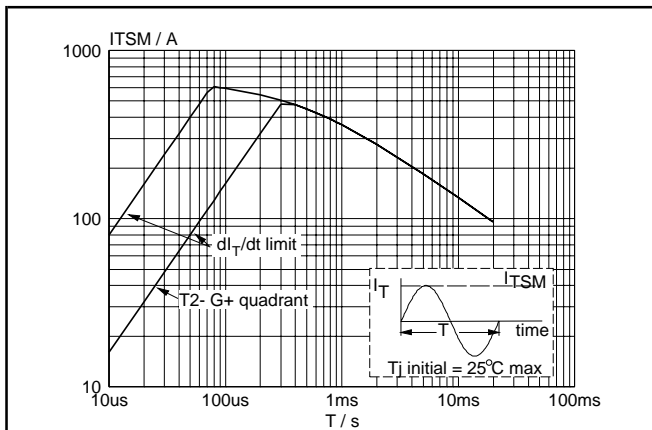

Fig.2. Maximum permissible non-repetitive peak on-state current  $I_{TSM}$ , versus pulse width  $t_p$ , for sinusoidal currents,  $t_p \leq 20ms$ .

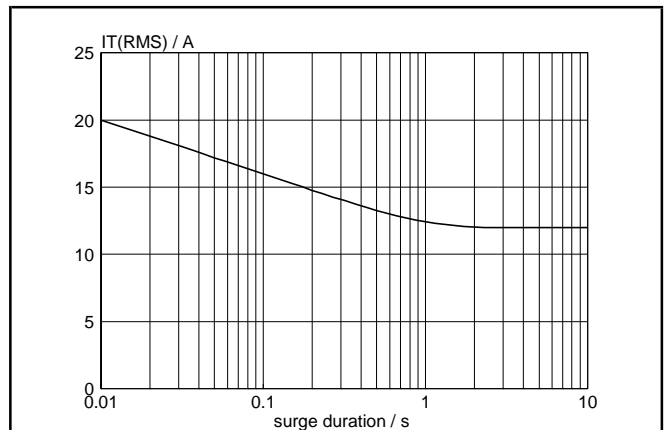

Fig.5. Maximum permissible repetitive rms on-state current  $I_{T(RMS)}$ , versus surge duration, for sinusoidal currents,  $f = 50 Hz$ ;  $T_{mb} \leq 99^\circ C$ .

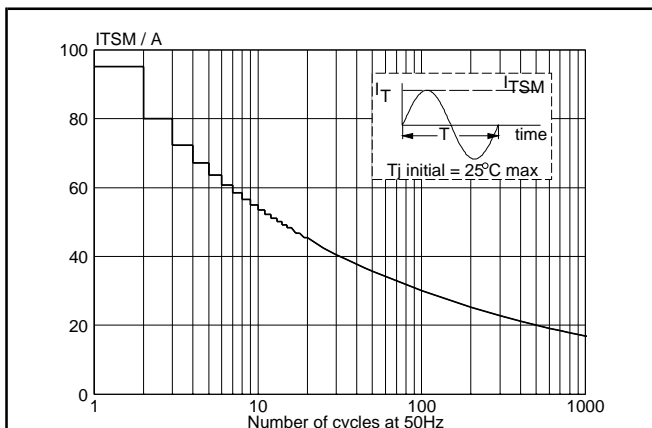

Fig.3. Maximum permissible non-repetitive peak on-state current  $I_{TSM}$ , versus number of cycles, for sinusoidal currents,  $f = 50 Hz$ .

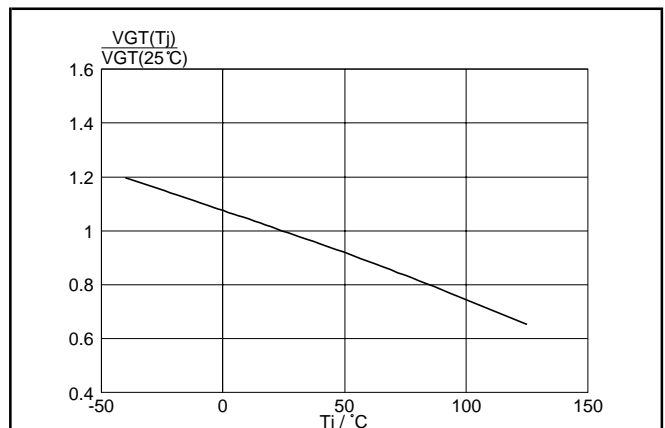
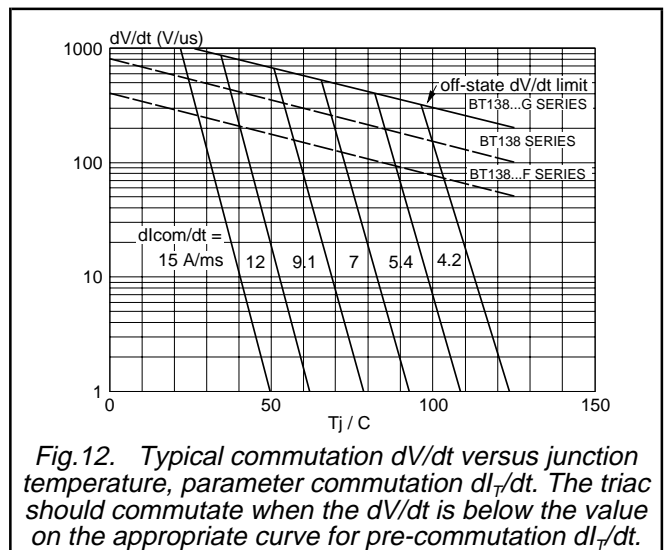
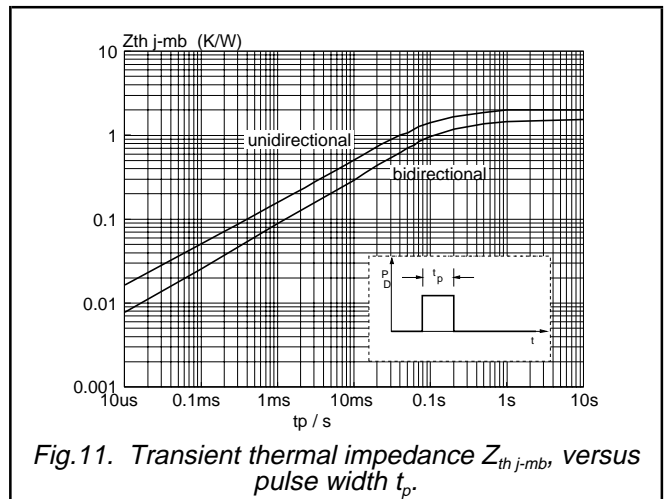
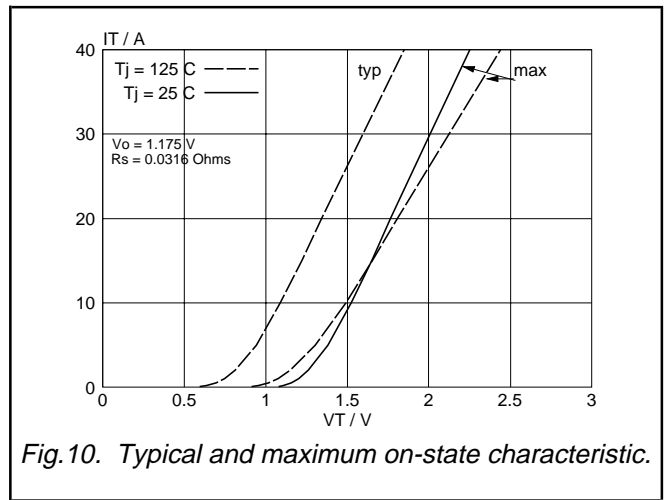
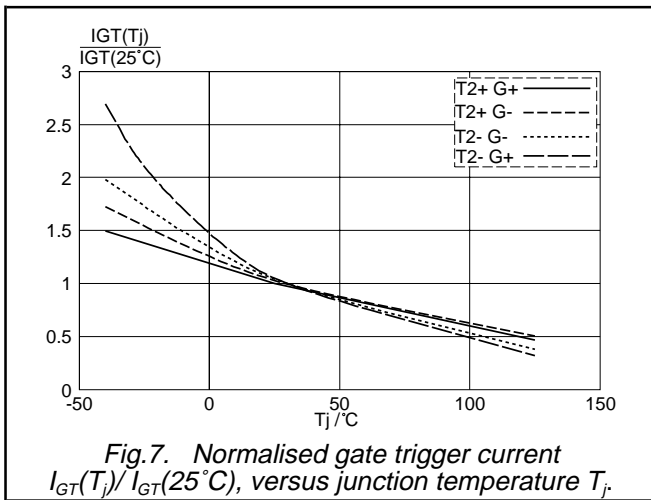

Fig.6. Normalised gate trigger voltage  $V_{GT}(T_j) / V_{GT}(25^\circ C)$ , versus junction temperature  $T_j$ .

Triacs

BT138 series



Triacs

BT138 series

**MECHANICAL DATA**

*Dimensions in mm*

*Net Mass: 2 g*

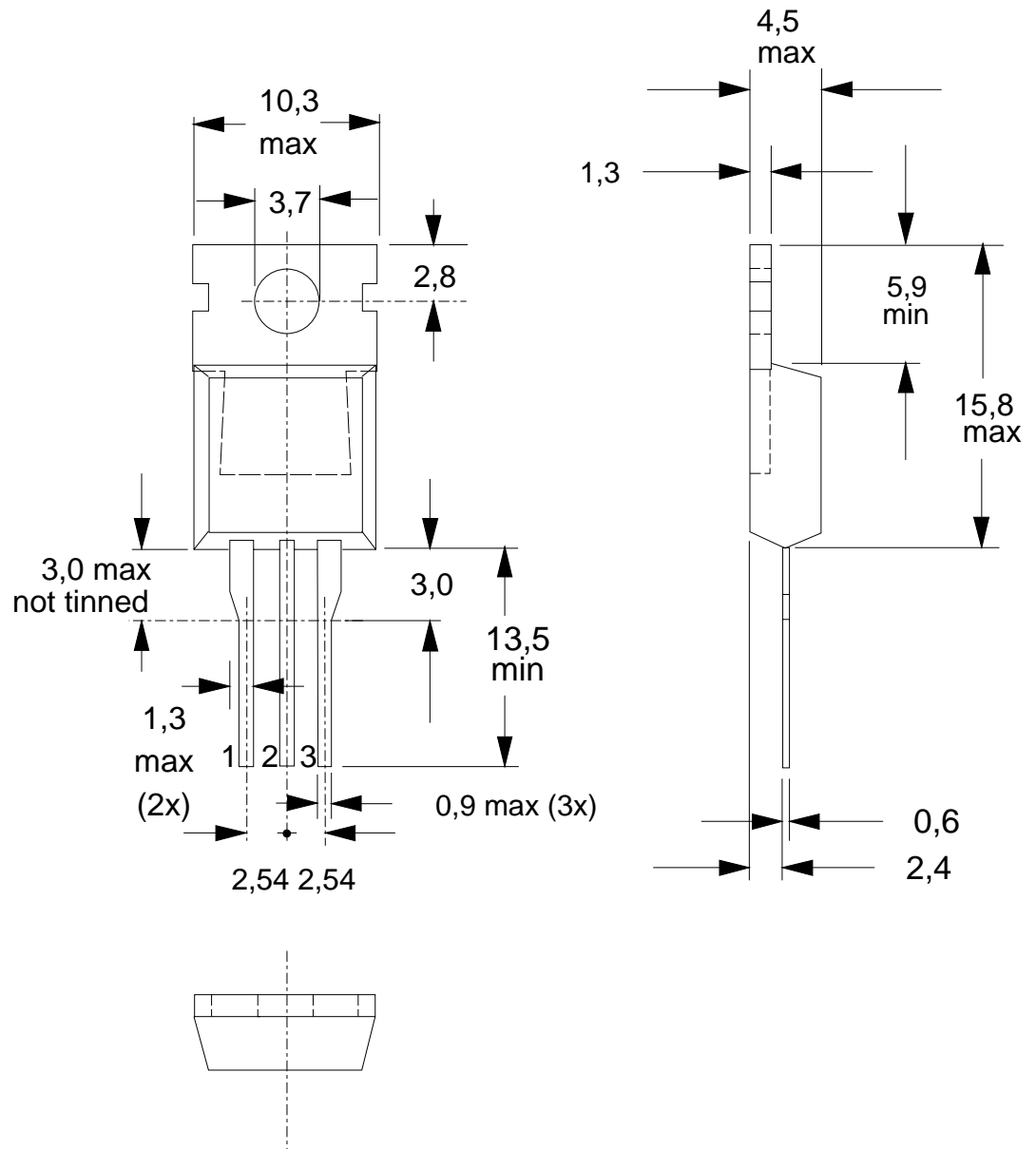

Fig.13. TO220AB; pin 2 connected to mounting base.

**Notes**

1. Refer to mounting instructions for TO220 envelopes.
2. Epoxy meets UL94 V0 at 1/8".

## Triacs

## BT138 series

**DEFINITIONS**

<b>Data sheet status</b>	
Objective specification	This data sheet contains target or goal specifications for product development.
Preliminary specification	This data sheet contains preliminary data; supplementary data may be published later.
Product specification	This data sheet contains final product specifications.
<b>Limiting values</b>	
Limiting values are given in accordance with the Absolute Maximum Rating System (IEC 134). Stress above one or more of the limiting values may cause permanent damage to the device. These are stress ratings only and operation of the device at these or at any other conditions above those given in the Characteristics sections of this specification is not implied. Exposure to limiting values for extended periods may affect device reliability.	
<b>Application information</b>	
Where application information is given, it is advisory and does not form part of the specification.	
© Philips Electronics N.V. 1997	
All rights are reserved. Reproduction in whole or in part is prohibited without the prior written consent of the copyright owner.	
The information presented in this document does not form part of any quotation or contract, it is believed to be accurate and reliable and may be changed without notice. No liability will be accepted by the publisher for any consequence of its use. Publication thereof does not convey nor imply any license under patent or other industrial or intellectual property rights.	

**LIFE SUPPORT APPLICATIONS**

These products are not designed for use in life support appliances, devices or systems where malfunction of these products can be reasonably expected to result in personal injury. Philips customers using or selling these products for use in such applications do so at their own risk and agree to fully indemnify Philips for any damages resulting from such improper use or sale.

This datasheet has been download from:

[www.datasheetcatalog.com](http://www.datasheetcatalog.com)

Datasheets for electronics components.