

AC12DGM to AC12FGM

12 A MOLD TRIAC

PACKAGE DIMENSIONS (Unit: mm)

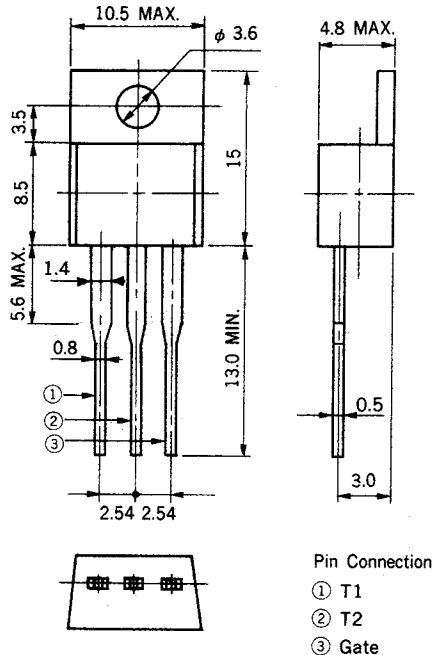

The AC12DGM to AC12FGM are all diffused mold type triac granted RMS On-state current 12 Amps, with rated voltages up to 600 volts.

FEATURES

- 100 A Surge Current
- TO-220AB mold package
- Low-cost

APPLICATIONS

- Motor speed control
- Lamp dimmer, Temperature controllers
- Various solid state switches, etc.

MAXIMUM RATINGS

CHARACTERISTIC	SYMBOL	AC12DGM	AC12EGM	AC12FGM	UNIT	NOTE
Repetitive Peak off Voltage	V_{DRM}	400	500	600	V	
Non-repetitive Peak off Voltage	V_{DSM}	500	600	700	V	
RMS On-State Current	I_T (RMS)	12 ($T_c = 98^\circ\text{C}$)			A	See Fig. 11, 12
Peak Surge On-State Current	I_{TSM}	100 (50 Hz, Non-repetitive)			A	See Fig. 2
Fusing Current	$\int i_T^2 dt$	45 ($1\text{ ms} \leq t \leq 10\text{ ms}$)			A^2s	
Peak Gate Power Dissipation	P_{GM}	5.0			W	
Average Gate Power Dissipation	P_G (AV)	0.5			W	
Peak Gate Current	I_{FGM}	± 3			A	
Junction Temperature	T_j	-40 to +125			$^\circ\text{C}$	
Storage Temperature	T_{stg}	-40 to +125			$^\circ\text{C}$	

ELECTRICAL CHARACTERISTICS ($T_j = 25^\circ\text{C}$)

CHARACTERISTIC		SYMBOL	TEST CONDITIONS	MIN.	TYP.	MAX.	UNIT	NOTE
Peak off-State Current		I_{DRM}	$T_j = 125^\circ\text{C}, V_{DM} = V_{DRM}$	-	-	2	mA	
On-State Voltage		V_{TM}	$I_{TM} = 10\text{ A}$	-	-	1.4	V	See Fig. 1
Gate Trigger Current	Trigger Mode I	I_{GT}	$V_{DM} = 12\text{ V}$ $R_L = 30\ \Omega$	-	-	30	mA	See Fig. 4
	II			-	-	80		
	III			-	-	30		
	IV			-	-	30		
Gate Trigger Voltage	Trigger Mode I	V_{GT}	$V_{DM} = 12\text{ V}$ $R_L = 30\ \Omega$	-	-	1.5	V	See Fig. 4
	II			-	-	2.0		
	III			-	-	1.5		
	IV			-	-	1.5		
Gate Non-Trigger Voltage		V_{GD}	$T_j = 125^\circ\text{C}$ $V_{DM} = 1/2 V_{DRM}$	0.3	-	-	V	
Commutating dv/dt		$(dv/dt)\text{ C}$	$T_j = 125^\circ\text{C}$ $(di_T/dt)\text{ C} = -6\text{ A/ms}$ $V_D = 400\text{ V}$	10	-	-	V/ μs	
Holding Current		I_H	$V_D = 24\text{ V}$	-	30	-	mA	
Thermal Resistance		$R_{th(j-c)}$	Junction to Case	-	-	1.8	$^\circ\text{C/W}$	See Fig. 13

Trigger Mode & Test Circuit

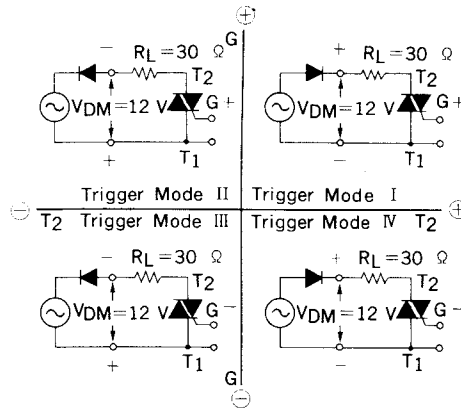

Fig. 1 $i_T - v_T$ CHARACTERISTIC

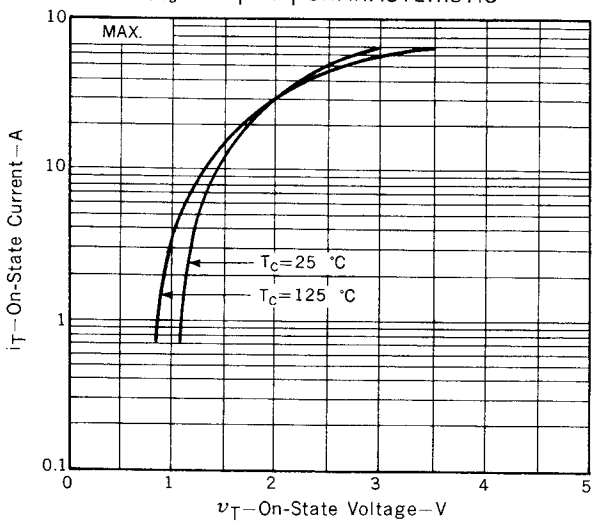

Fig. 2 I_{TSM} RATING

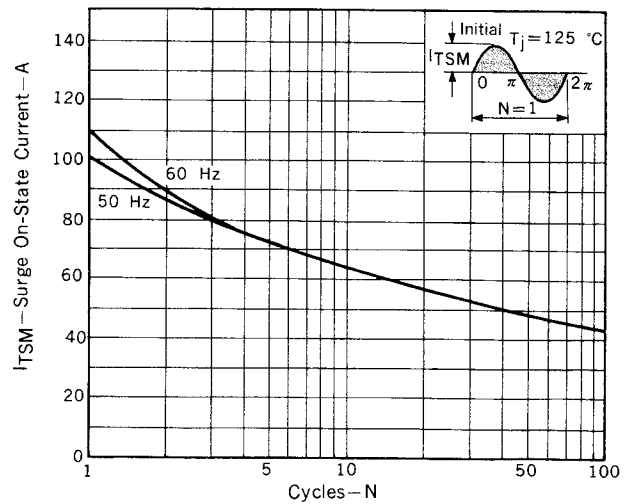

Fig. 3 $V_G - I_G$ RATING

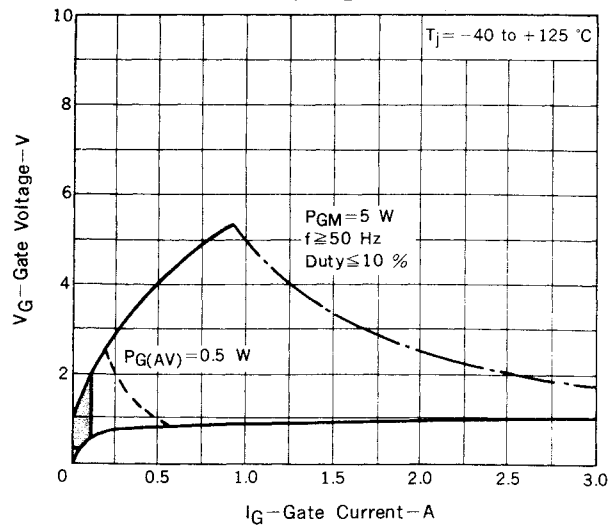

Fig. 4 $V_{GT} - I_{GT}$ CHARACTERISTIC

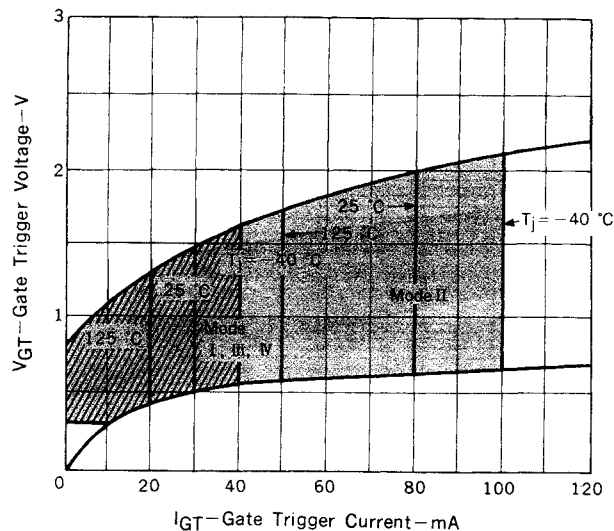

Fig. 5 $I_{GT} - T_a$ TYPICAL DISTRIBUTION

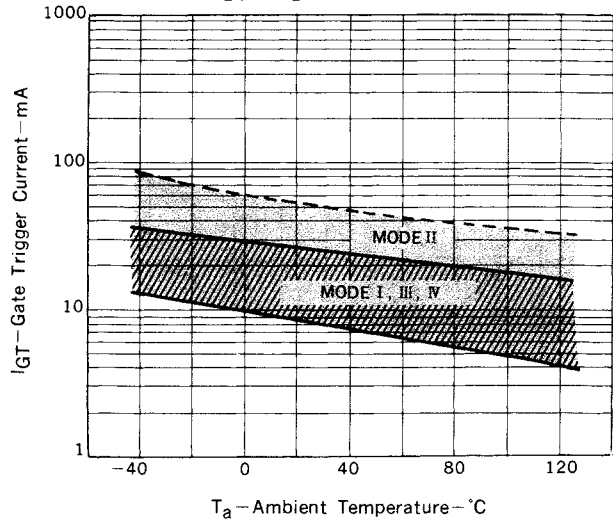

Fig. 6 $V_{GT} - T_a$ TYPICAL DISTRIBUTION

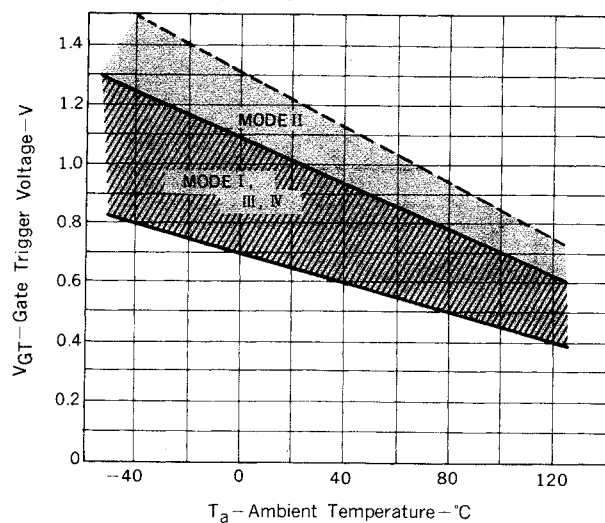

Fig. 7 $i_{GT} - \tau$ TYPICAL DISTRIBUTION

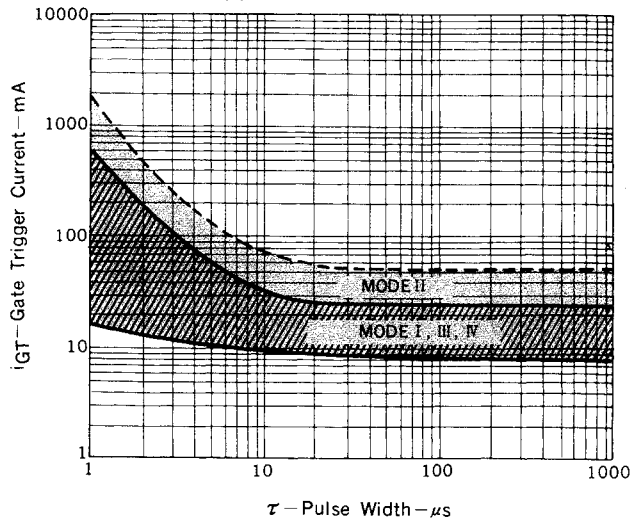

Fig. 8 $v_{GT} - \tau$ TYPICAL DISTRIBUTION

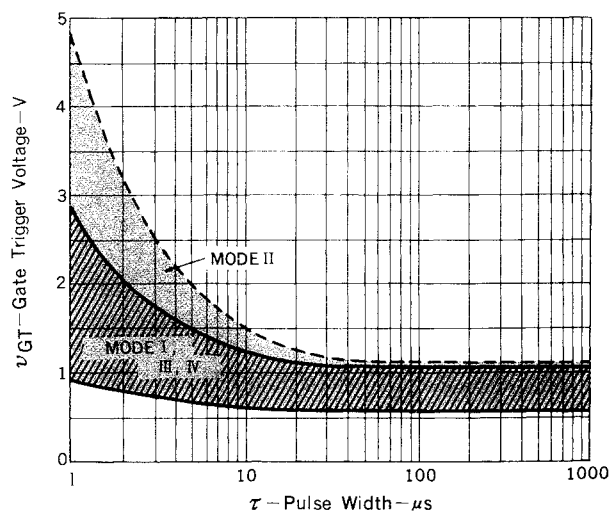

Fig. 9 $I_H - T_a$ TYPICAL DISTRIBUTION

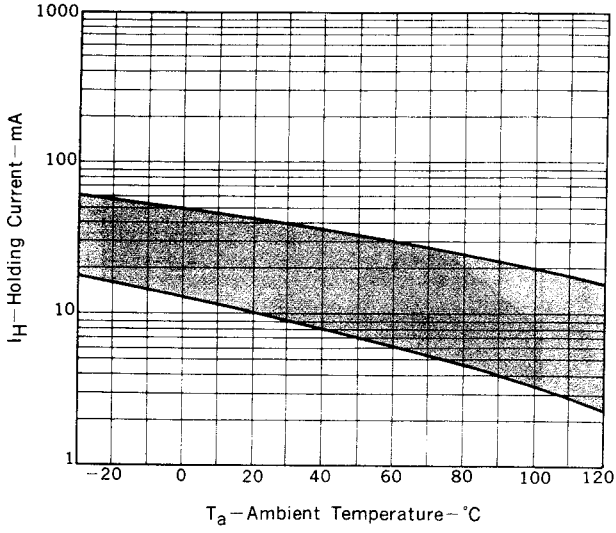

Fig. 10 $P_{T(AV)} - I_{T(RMS)}$ CHARACTERISTIC

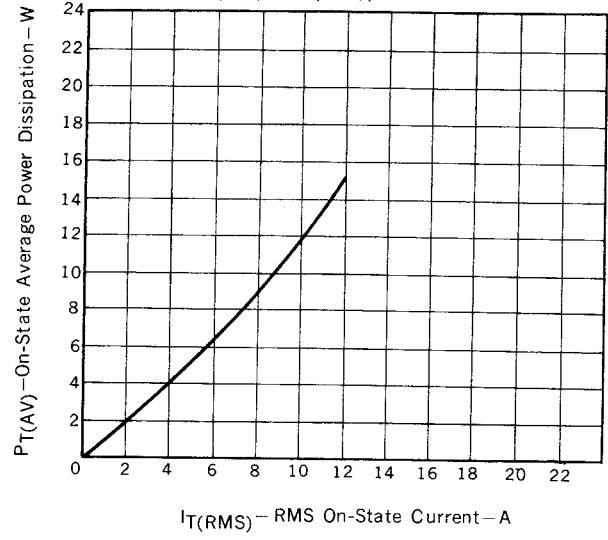

Fig. 11 $T_c - I_{T(RMS)}$ RATING

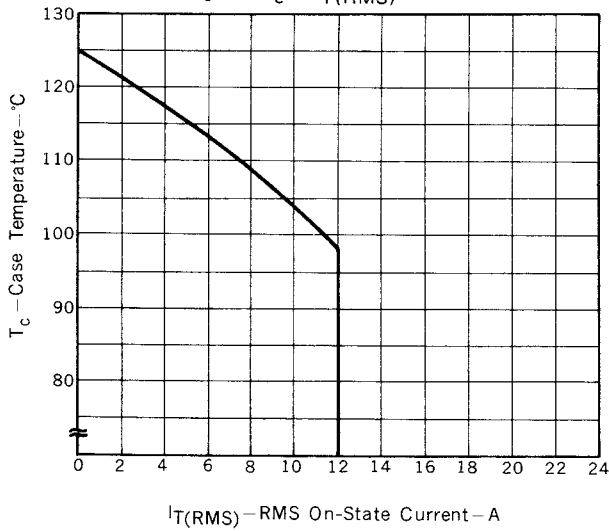

Fig. 12 $T_a - I_{T(RMS)}$ RATING

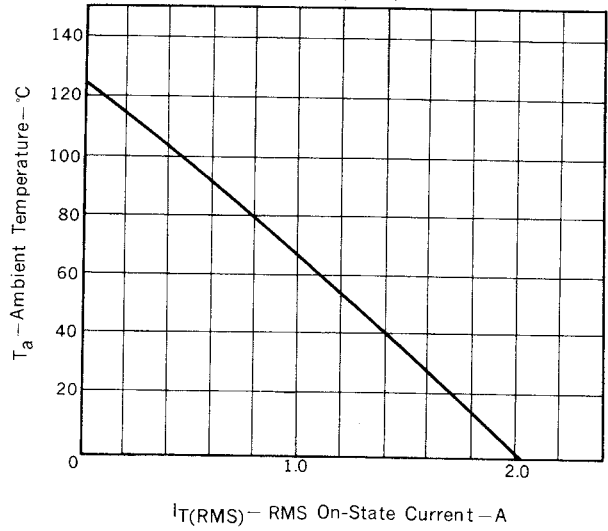
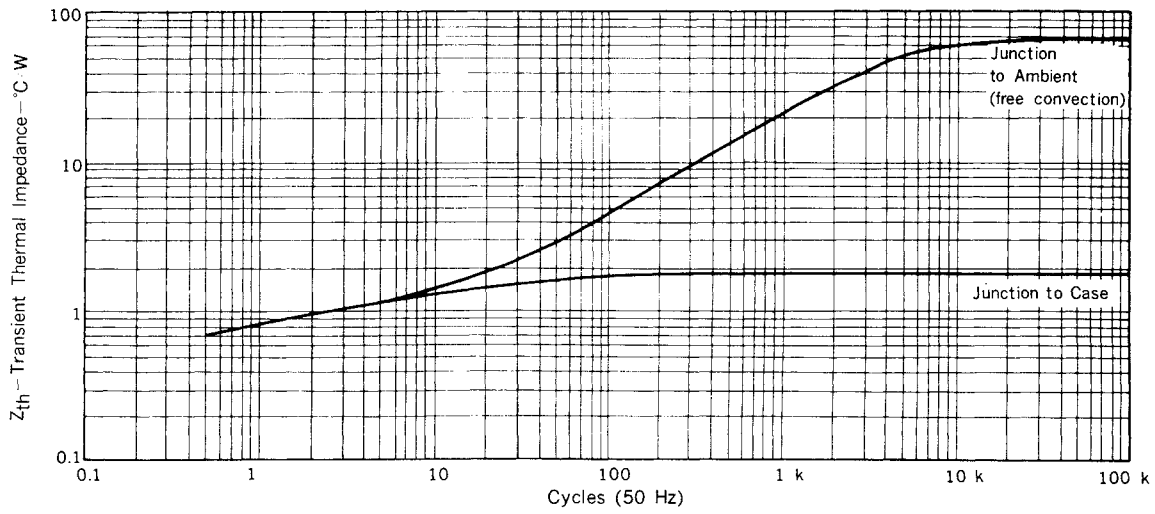

Fig. 13 Z_{th} CHARACTERISTIC



NEC Corporation

INTERNATIONAL ELECTRON DEVICES DIV.
SUMITOMO MITA Building, 37-8,
Shiba Gochome, Minato-ku, Tokyo 108, Japan
Tel: Tokyo 456-3111
Telex Address: NECTOK J22686
Cable Address: NEC TOKYO