

Silicon Diffused Power Transistor

**BUX86P
BUX87P**

GENERAL DESCRIPTION

High voltage, high speed glass passivated npn power transistors in a SOT82 envelope intended for use in converters, inverters, switching regulators, motor control systems and switching applications.

QUICK REFERENCE DATA

SYMBOL	PARAMETER	CONDITIONS	TYP.			UNIT
			BUX	86P	87P	
V_{CESM} V_{CEO}	Collector-emitter voltage peak value	$V_{BE} = 0 V$	-	800	1000	V
	Collector-emitter voltage (open base)		-	400	450	V
V_{CESAT}	Collector-emitter saturation voltage	$I_C = 0.2 A; I_B = 20 mA$	-	1		V
I_C	Collector current (DC)		-	0.5		A
I_{CM}	Collector current peak value		-	1		A
P_{tot}	Total power dissipation	$T_{mb} \leq 25 ^\circ C$	-	42		W
t_f	Fall time	$I_C = 0.2 A; I_{B(on)} = 20 mA$	0.28	-		μs

PINNING - SOT82

PIN	DESCRIPTION
1	emitter
2	collector
3	base

PIN CONFIGURATION

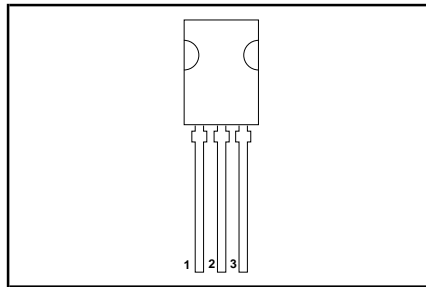

SYMBOL

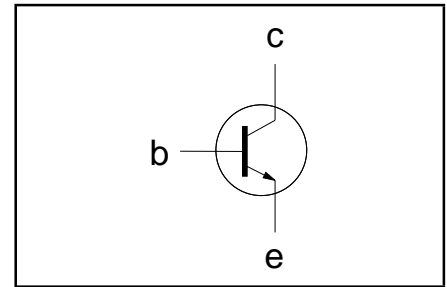

LIMITING VALUES

Limiting values in accordance with the Absolute Maximum Rating System (IEC 134)

SYMBOL	PARAMETER	CONDITIONS	MIN.			MAX.			UNIT
			BUX	86P	87P	BUX	86P	87P	
V_{CESM} V_{CEO}	Collector-emitter voltage peak value	$V_{BE} = 0 V$	-	800	1000	-	800	1000	V
	Collector-emitter voltage (open base)		-	400	450	-	400	450	V
V_{EBO}	Emitter-base voltage (open collector)	$T_{mb} \leq 25 ^\circ C$	-	5		-	5		V
I_C	Collector current (DC)		-	0.5		-	0.5		A
I_{CM}	Collector current (peak value) $t_p = 2 ms$		-	1		-	1		A
I_B	Base current (DC)	$T_{mb} \leq 25 ^\circ C$	-	0.2		-	0.2		A
I_{BM}	Base current (peak value)		-	0.3		-	0.3		A
$-I_{BM}$	Reverse base current (peak value) ¹		-	0.3		-	0.3		A
P_{tot}	Total power dissipation	$T_{mb} \leq 25 ^\circ C$	-	42		-	42		W
T_{stg}	Storage temperature	$T_{mb} \leq 25 ^\circ C$	-40	150		-40	150		$^\circ C$
T_j	Junction temperature		-	150		-	150		$^\circ C$

¹ Turn-off current.

Silicon Diffused Power Transistor

BUX86P
BUX87P

THERMAL RESISTANCES

SYMBOL	PARAMETER	CONDITIONS	TYP.	MAX.	UNIT
$R_{th\ j-mb}$	Junction to mounting base		-	3	K/W
$R_{th\ j-a}$	Junction to ambient	in free air	100	-	K/W

STATIC CHARACTERISTICS

 $T_{mb} = 25\text{ }^{\circ}\text{C}$ unless otherwise specified

SYMBOL	PARAMETER	CONDITIONS	MIN.	TYP.	MAX.	UNIT
I_{CES}		$V_{BE} = 0\text{ V}; V_{CE} = V_{CESMmax}$	-	-	100	μA
I_{CES}		$V_{BE} = 0\text{ V}; V_{CE} = V_{CESMmax}$	-	-	1.0	mA
I_{EBO}	Emitter cut-off current	$T_j = 125\text{ }^{\circ}\text{C}$ $V_{EB} = 5\text{ V}; I_C = 0\text{ A}$	-	-	1	mA
V_{CEsat}	Collector-emitter saturation voltages	$I_C = 0.1\text{ A}; I_B = 10\text{ mA}$	-	-	0.8	V
V_{CEsat}		$I_C = 0.2\text{ A}; I_B = 20\text{ mA}$	-	-	1	V
V_{BEsat}	Base-emitter saturation voltage	$I_C = 0.2\text{ A}; I_B = 20\text{ mA}$	-	-	1	V
h_{FE}	DC current gain	$I_C = 50\text{ mA}; V_{CE} = 5\text{ V}$	26	50	125	
$V_{CEOsust}$	Collector-emitter sustaining voltage	$I_C = 100\text{ mA};$	400	-	-	V
		$I_{Boff} = 0; L = 25\text{ mH}$	BUX86P BUX87P	450	-	-

DYNAMIC CHARACTERISTICS

 $T_{mb} = 25\text{ }^{\circ}\text{C}$ unless otherwise specified

SYMBOL	PARAMETER	CONDITIONS	TYP.	MAX.	UNIT
	Switching times (resistive load).	$I_C = 0.2\text{ A}; I_{Bon} = 20\text{ mA}; -I_{Boff} = 40\text{ mA};$ $V_{CC} = 250\text{ V}$			
t_{on}	Turn-on time		0.25	0.5	μs
t_s	Turn-off storage time		2	3.5	μs
t_f	Turn-off fall time		0.28	-	μs
t_f	Turn-off fall time	$T_{mb} = 95\text{ }^{\circ}\text{C}$	-	1.3	μs

Silicon Diffused Power Transistor

BUX86P
BUX87P

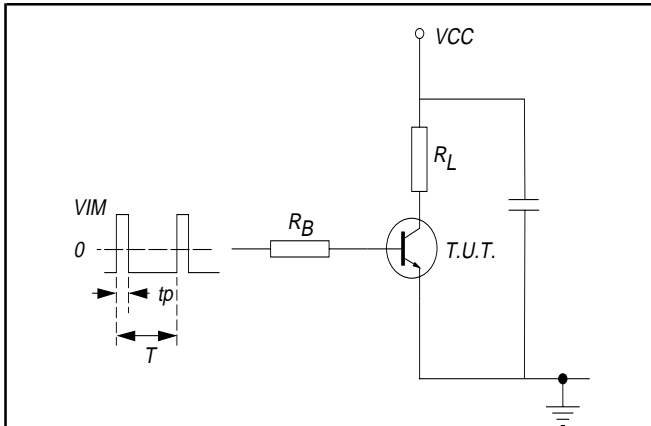

Fig. 1. Test circuit resistive load. $V_{IM} = -6$ to $+8$ V
 $V_{CC} = 250$ V; $t_p = 20 \mu s$; $\delta = t_p / T = 0.01$.
 R_B and R_L calculated from I_{Con} and I_{Bon} requirements.

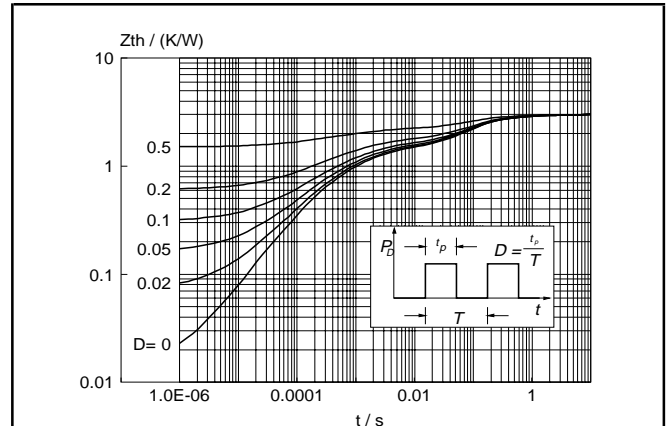

Fig. 4. Transient thermal impedance.
 $Z_{thj-mb} = f(t)$; parameter $D = t_p / T$

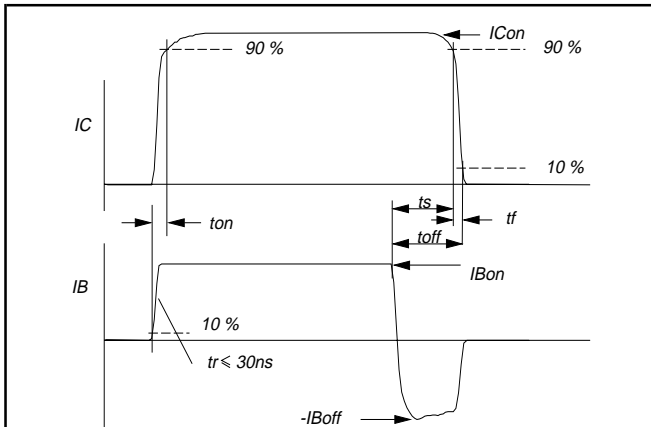

Fig. 2. Switching times waveforms with resistive load.

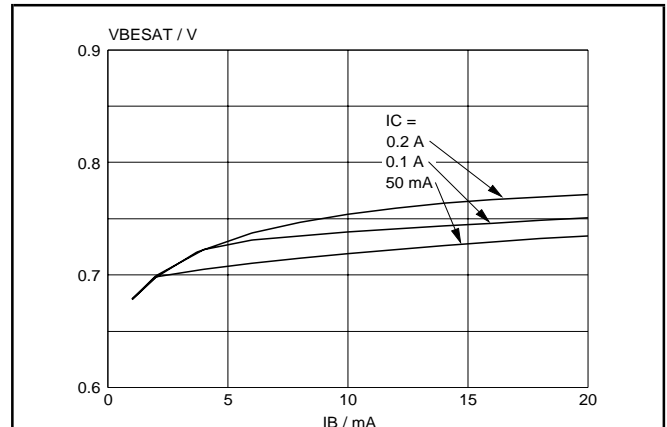

Fig. 5. Typical base-emitter saturation voltage.
 $V_{BEsat} = f(I_B)$; parameter I_C

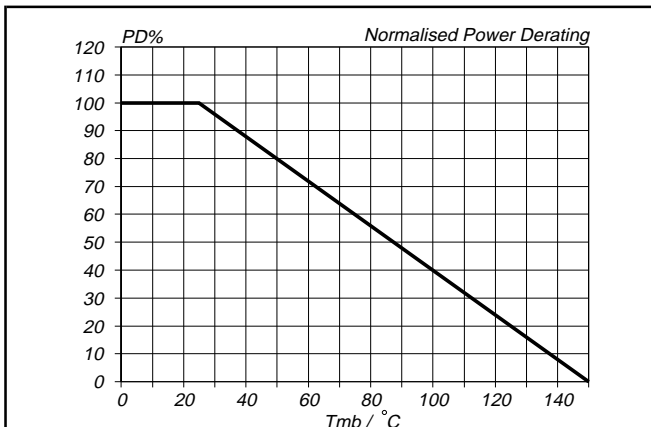

Fig. 3. Normalised power dissipation.
 $PD\% = 100 \cdot PD / PD_{25^\circ C} = f(T_{mb})$

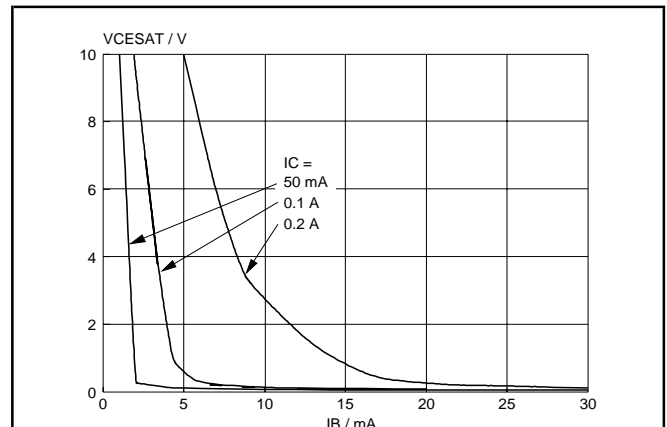
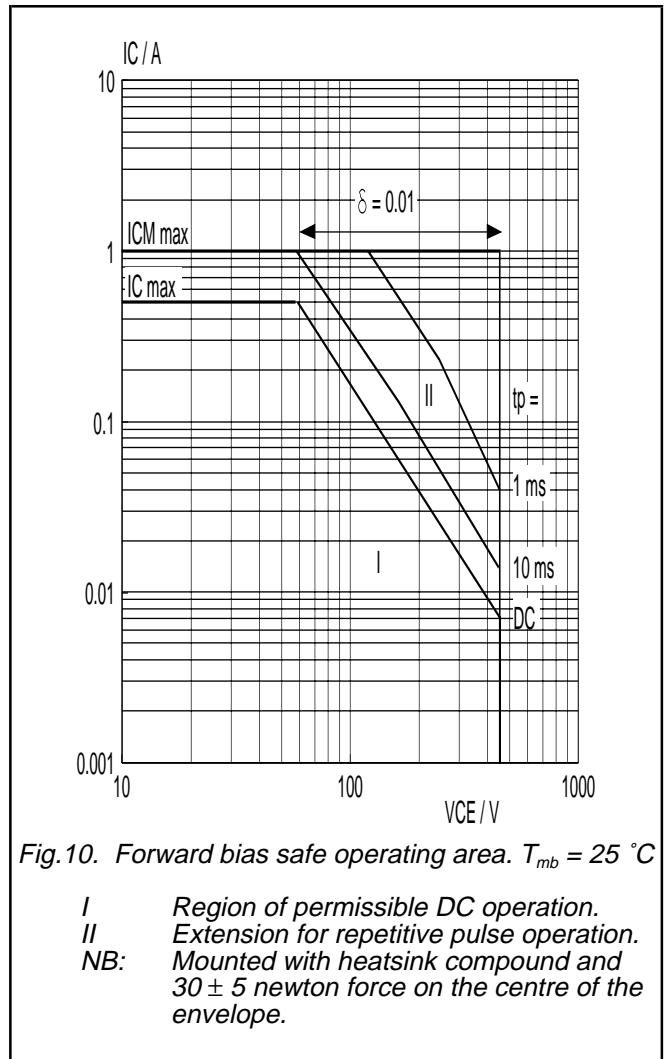
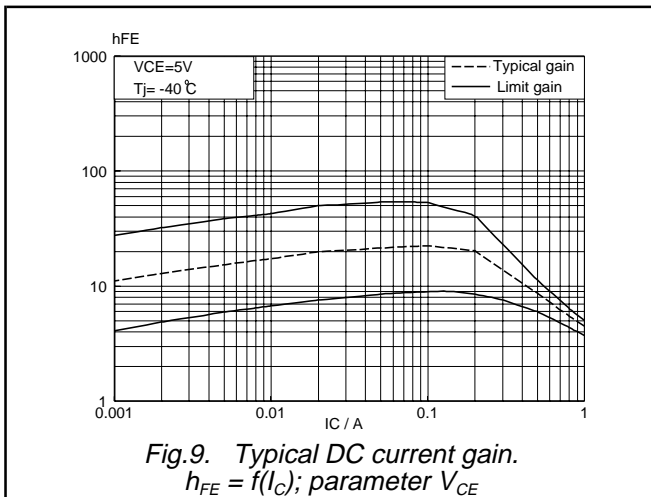
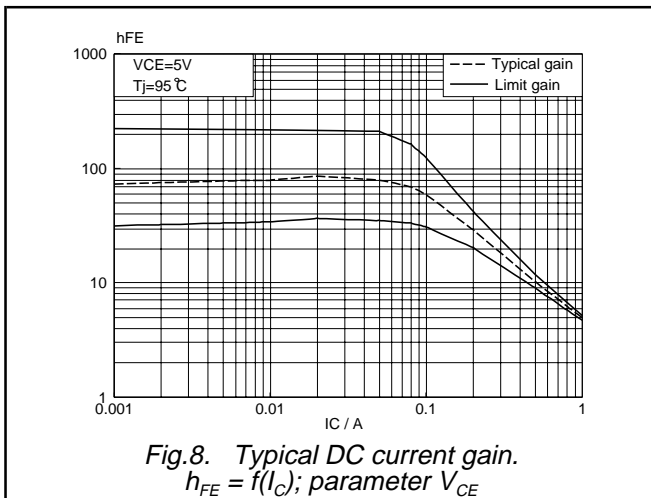
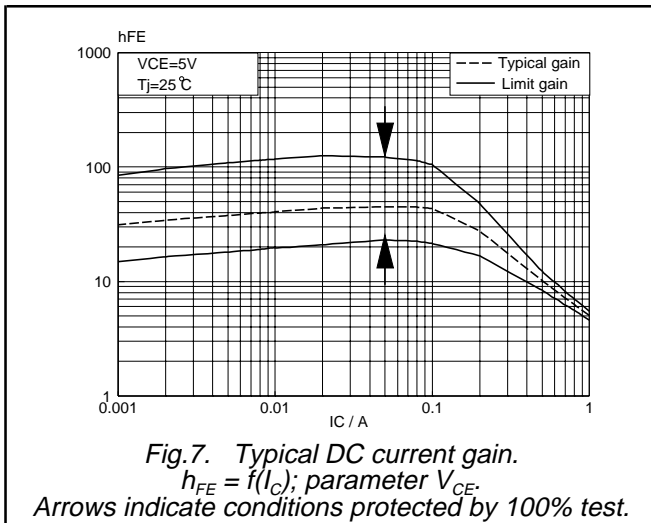

Fig. 6. Typical collector-emitter saturation voltage.
 $V_{CESat} = f(I_B)$; parameter I_C

Silicon Diffused Power Transistor

BUX86P
BUX87P



Silicon Diffused Power Transistor

BUX86P
BUX87P

MECHANICAL DATA

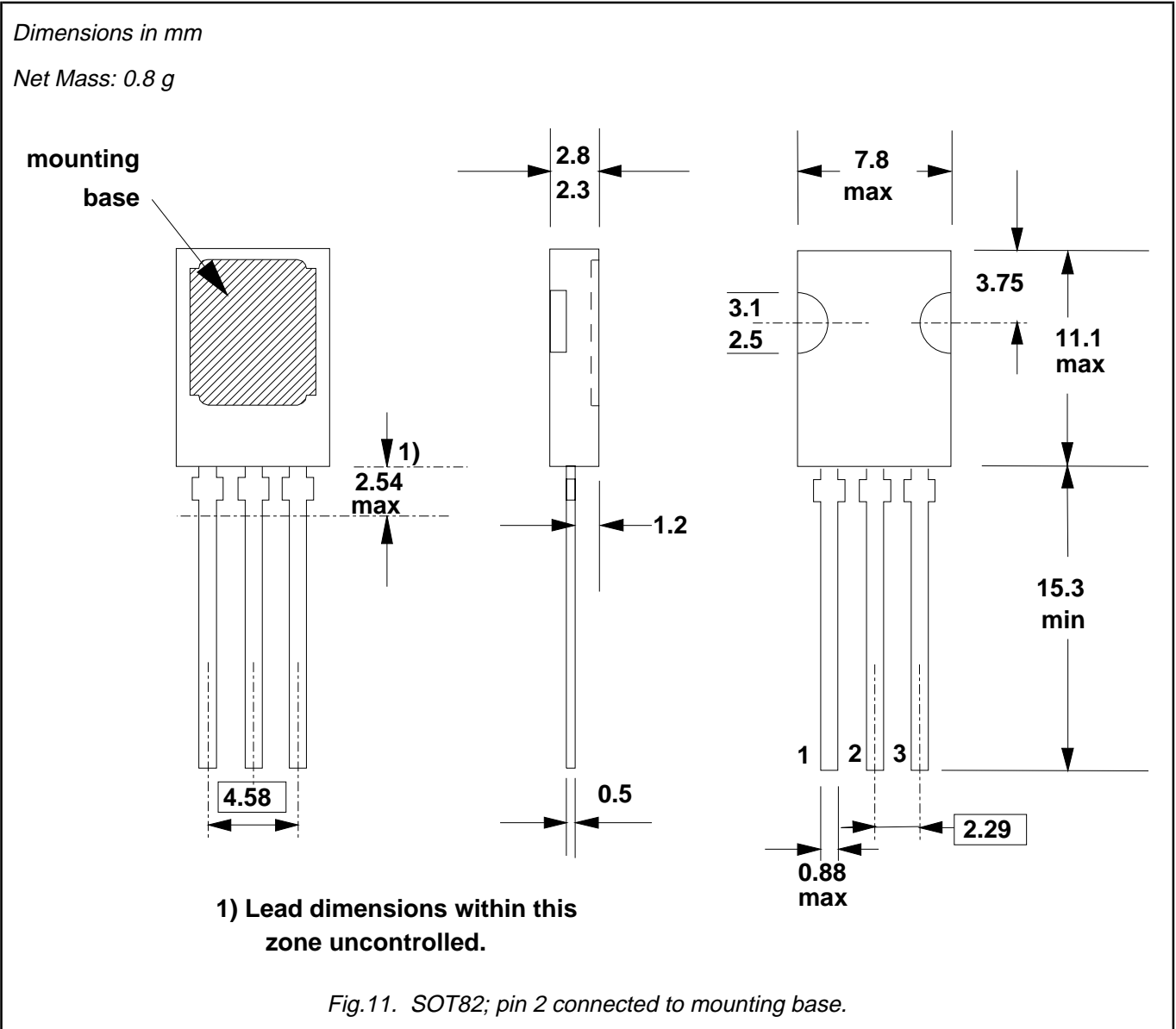

Notes

1. Refer to mounting instructions for SOT82 envelopes.
2. Epoxy meets UL94 V0 at 1/8".

Silicon Diffused Power Transistor

BUX86P
BUX87P**DEFINITIONS**

Data sheet status	
Objective specification	This data sheet contains target or goal specifications for product development.
Preliminary specification	This data sheet contains preliminary data; supplementary data may be published later.
Product specification	This data sheet contains final product specifications.
Limiting values	
Limiting values are given in accordance with the Absolute Maximum Rating System (IEC 134). Stress above one or more of the limiting values may cause permanent damage to the device. These are stress ratings only and operation of the device at these or at any other conditions above those given in the Characteristics sections of this specification is not implied. Exposure to limiting values for extended periods may affect device reliability.	
Application information	
Where application information is given, it is advisory and does not form part of the specification.	
© Philips Electronics N.V. 1997	
All rights are reserved. Reproduction in whole or in part is prohibited without the prior written consent of the copyright owner.	
The information presented in this document does not form part of any quotation or contract, it is believed to be accurate and reliable and may be changed without notice. No liability will be accepted by the publisher for any consequence of its use. Publication thereof does not convey nor imply any license under patent or other industrial or intellectual property rights.	

LIFE SUPPORT APPLICATIONS

These products are not designed for use in life support appliances, devices or systems where malfunction of these products can be reasonably expected to result in personal injury. Philips customers using or selling these products for use in such applications do so at their own risk and agree to fully indemnify Philips for any damages resulting from such improper use or sale.