



5A ULDO LINEAR REGULATORS FAMILY

- UP TO 5A OUTPUT CURRENT
- $\pm 2\%$ PRECISE OUTPUT VOLTAGES
- FAST TRANSIENT RESPONSE
- 0.75V TYP. DROP OUT VOLTAGE AT 5A
- OPERATING INPUT VOLTAGE FROM 4.5V
- ADJUSTABLE VERSION:
 - $V_O = 1.26V$
 - INHIBIT ($I_Q = 120\mu A$ TYP.)
 - POWER GOOD
 - PROGRAMMABLE CURRENT LIMIT
 - HEPTAWATT PACKAGE
- FIXED VERSION:
 - 3.3V, 5.1V OUTPUTS
 - VERSAWATT PACKAGE
- VERY LOW QUIESCENT CURRENT
- SHORT CIRCUIT PROTECTION (Foldback function)
- THERMAL SHUTDOWN

APPLICATIONS

- PENTIUM™ AND POWER PC™ SUPPLIES
- POST REGULATOR FOR SMPS
- LOW COST SOLUTION FOR 5V TO 3.3V CONVERSION
- LOW COST BATTERY CHARGER
- CONSTANT CURRENT REGULATOR
- SUITABLE FOR APPLICATION WITH STANDBY FEATURE

DESCRIPTION

The L4955 is a family of monolithic ultra very low drop linear regulators designed to supply the most recent microprocessors.

TYPICAL APPLICATIONS

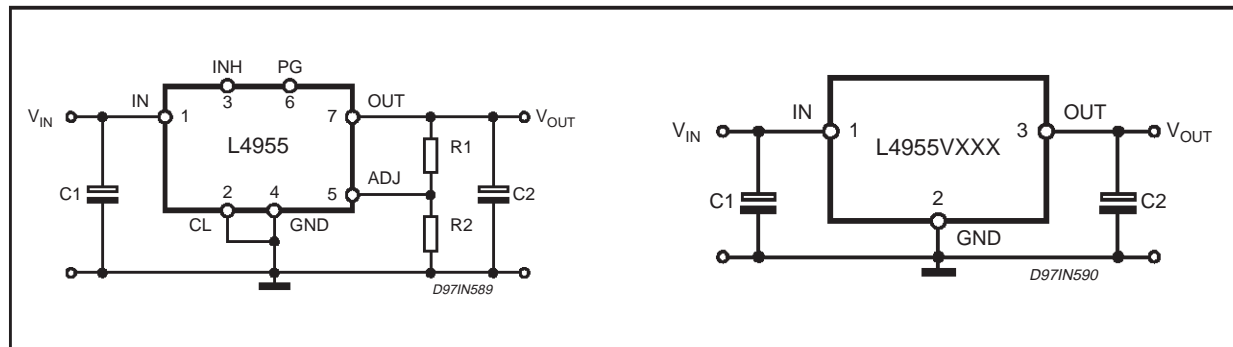

MULTIPOWER BCD TECHNOLOGY

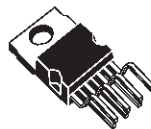

HEPTAWATT

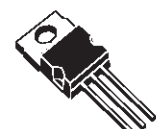

VERSAWATT (TO-220)

ORDERING NUMBERS	OUTPUT VOLTAGE	PACKAGE
L4955	1.26V ADJ	HEPTAWATT
L4955V3.3	3.3V	VERSAWATT
L4955V5.1	5.1V	VERSAWATT

The dropout voltage is only 0.75V (Typ.) at 5A, directly dependent on the output current conditions.

Realized in BCDII technology, it has on board a charge pump to properly drive an N-channel power mos Transistor with 150mΩ of $R_{DS(ON)}$.

It operates from a 4.5V minimum supply, with a very low quiescent current irrespective of the load; a minimum of 22μF output capacitor is required for stability.

The on-chip trimming techniques improve the precision of the available output voltages to $\pm 2\%$.

Ancillary functions like power good, inhibit with low power consumption, programmable output voltage and current limiting make the flexible heptawatt version usable in applications where power management, stand-by, features, post regulation and adjustable current generators for battery chargers are important.

ABSOLUTE MAXIMUM RATINGS

Symbol	Parameter	Value	Unit
V_{IN}	Supply Input Voltage	24	V
	ADJ and CL pins	-0.3 to 4	V
	PG and INH pins	0 to V_{IN}	V
P_{TOT}	Power Dissipation @ $T_{amb} = 50^{\circ}C$	2	W
	Power Dissipation @ $T_{case} = 90^{\circ}C$	15	W
T_{st}, T_i	Storage Temperature	-40 to +150	$^{\circ}C$

PIN CONNECTIONS (Top views)

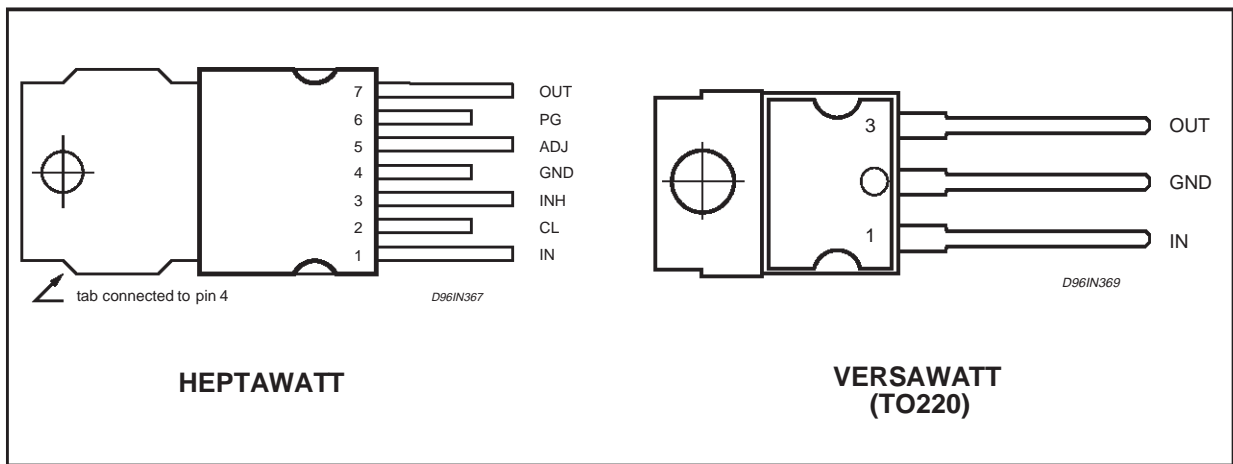

BLOCK DIAGRAM

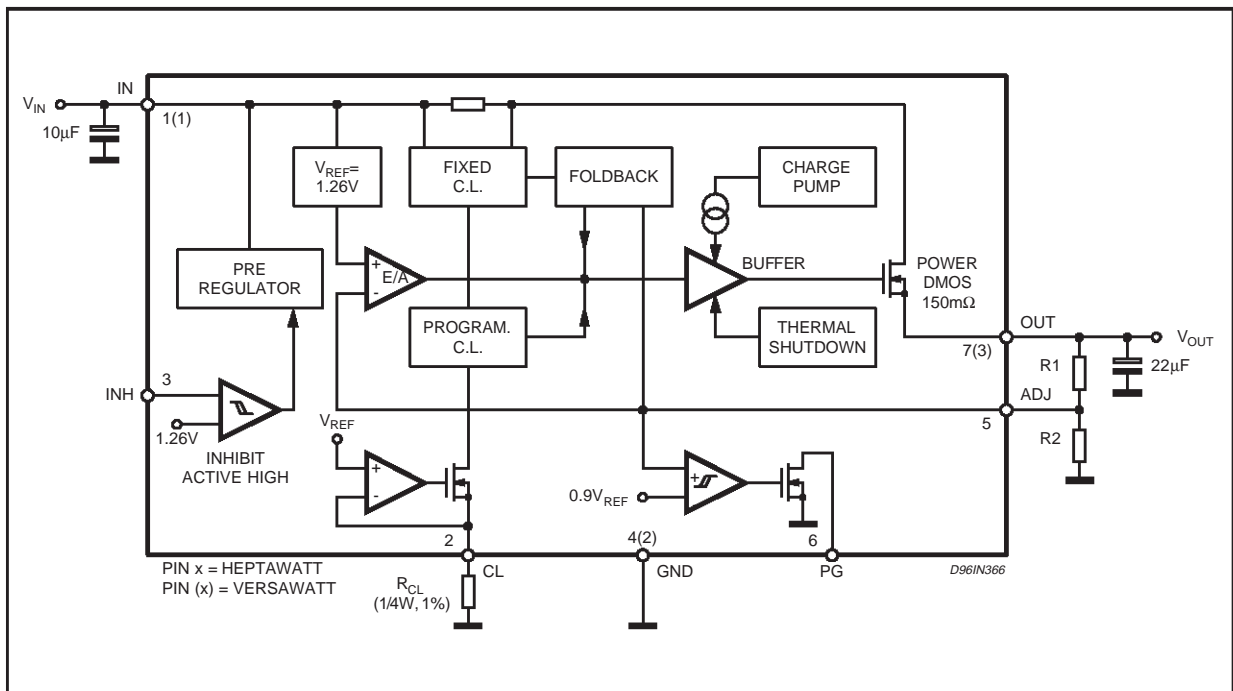

PIN FUNCTIONS

HW	VW	Name	Function
1	1	IN	Unregulated input voltage; this pin must be bypassed with a capacitor larger than 10 μ F.
2	–	CL	A resistor connected between this pin and ground sets the programmable current limiting value. When the programmable current limiting is not used the pin must be connected to GND.
3	–	INH	TTL-CMOS input. A logic high level on this input disables the device. An internal pull-down insures full functionality even if the pin is open.
4	2	GND	Ground.
5	–	ADJ	The output is connected directly to this terminal for 1.26V operation; it is connected to the output through a resistive divider for higher voltages.
6	–	PG	Open drain output, this signal is low when the output voltage is lower than 90%, otherwise is high.
7	3	OUT	Regulated output voltage. A minimum bypass capacitor of 22 μ F is required to insure stability.

THERMAL DATA (HEPTAWATT & VERSAWATT packages)

Symbol	Parameter	Value	Unit
R _{th j-case}	Thermal Resistance Junction-case	Max. 2.5	°C/W
R _{th j-amb}	Thermal Resistance Junction-ambient	Max. 50	°C/W
	Thermal Shutdown	Typ. 150	°C
	Thermal Hysteresis	Typ. 20	°C

L4955 - ELECTRICAL CHARACTERISTICS (T_J = 25°C, V_{in} = 12V, unless otherwise specified).

● = Specifications referred to T_J from 0°C to +125°C.

Symbol	Parameter	Test Condition	Min.	Typ.	Max.	Unit
V _{IN}	Operating Supply Voltage		4.5		22	V
V _O	Output Voltage (1)	0.1A < I _O < 5A; 4.5V < V _{IN} < 12V	1.235	1.26	1.285	V
		4.5V < V _{IN} < 12V; 0.1A < I _O < 5A	● 1.222	1.26	1.298	V
Δ V _O	Line regulation (1)	4.5V < V _{IN} < 22V; I _O = 10mA		2	10	mV
Δ V _O	Load regulation (1)	0.1A < I _O < 5A		2	10	mV
V _O	Dropout Voltage	I _O = 5A		0.75	1.1	V
		V _{IN} \geq 4.5V	●	1.1	1.5	V
		I _O = 2A	●	0.55	0.75	V
I _O	Current Limiting		● 5.1	6.3	7.5	A
	Short Circuit Current	V _O = 0V	●	1.8		A
	Programmable Current Limiting	R _{lim} = 13k Ω	● 2.55	3	3.45	A
		R _{lim} = 47k Ω	● 0.70	0.85	1.00	A
I _Q	Quiescent Current	0.1A < I _O < 5A		2	3	mA
		C _L = 0 C _L = 13k		2.7	4	mA
	Stand By Current	INH = 5V		120	200	μ A
	Inhibit Threshold	Rising Edge	● 1.1	1.26	1.42	V
	Inhibit Hysteresis			0.2		V
	Inhibit Bias Sink Current	INH = 5V or 0.8V		20	60	μ A
	Power Good Threshold	Rising Edge		0.9 x V _O		V
	Power Good Hysteresis		●	0.2		V
	Power Good Saturation	I _{PG} = 4mA	●	0.1	0.4	V
	Ripple Rejection	f = 120Hz, I _O = 5A V _{IN} = 6V Δ V _{IN} = 2V _{PP}	60	75		dB

(1) Output voltage connected to ADJ.

L4955

L4955V3.3 - ELECTRICAL CHARACTERISTICS ($T_J = 25^\circ\text{C}$, $V_{in} = 5\text{V}$, unless otherwise specified)

● = Specifications referred to T_J from 0°C to $+125^\circ\text{C}$.

Symbol	Parameter	Test Condition		Min.	Typ.	Max.	Unit
V_{IN}	Operating Input Voltage			4.5		22	V
V_O	Output Voltage	$4.75\text{V} < V_{IN} < 12\text{V}$; $0.1\text{A} < I_O < 5\text{A}$		3.234	3.300	3.366	V
		$4.75\text{V} < V_{IN} < 12\text{V}$; $0.1\text{A} < I_O < 5\text{A}$	●	3.201	3.300	3.399	V
ΔV_O	Line regulation	$4.5\text{V} < V_{IN} < 12\text{V}$; $I_O = 10\text{mA}$			2	10	mV
ΔV_O	Load regulation	$0.1\text{A} < I_O < 5\text{A}$			3	15	mV
I_O	Current Limiting		●	5.1	6.3	7.5	A
	Short Circuit Current	$V_O = 0\text{V}$	●		1.8		A
I_Q	Quiescent Current	$0.1\text{A} < I_O < 5\text{A}$			2	3	mA
	Ripple Rejection	$f = 120\text{Hz}$, $I_O = 5\text{A}$ $V_{IN} = 6\text{V}$ $\Delta V_{IN} = 2V_{PP}$		57	70		dB

L4955V5.1 - ELECTRICAL CHARACTERISTICS ($T_J = 25^\circ\text{C}$, $V_{in} = 8\text{V}$, unless otherwise specified)

● = Specifications referred to T_J from 0°C to $+125^\circ\text{C}$.

Symbol	Parameter	Test Condition		Min.	Typ.	Max.	Unit
V_{IN}	Operating Input Voltage			$V_O + V_D$		22	V
V_O	Output Voltage	$6.75\text{V} < V_{IN} < 15\text{V}$; $0.1\text{A} < I_O < 5\text{A}$		5.000	5.100	5.200	V
		$6.75\text{V} < V_{IN} < 15\text{V}$; $0.1\text{A} < I_O < 5\text{A}$	●	4.950	5.100	5.250	V
V_D	Drop-out Voltage	$I_O = 5\text{A}$			0.75	1.1	V
			●		1.1	1.5	V
		$I_O = 2\text{A}$	●		0.55	0.75	V
ΔV_O	Line regulation	$6.5\text{V} < V_{IN} < 15\text{V}$; $I_O = 10\text{mA}$			2	10	mV
ΔV_O	Load regulation	$0.1\text{A} < I_O < 5\text{A}$			5	20	mV
I_O	Current Limiting		●	5.1	6.3	7.5	A
	Short Circuit Current	$V_O = 0\text{V}$	●		1.8		A
I_Q	Quiescent Current	$0.1\text{A} < I_O < 5\text{A}$			2	3	mA
	Ripple Rejection	$f = 120\text{Hz}$, $I_O = 5\text{A}$ $V_{IN} = 8\text{V}$ $\Delta V_{IN} = 2V_{PP}$		55	65		dB

L4955

Figure 1: L4955 DC Operating Area

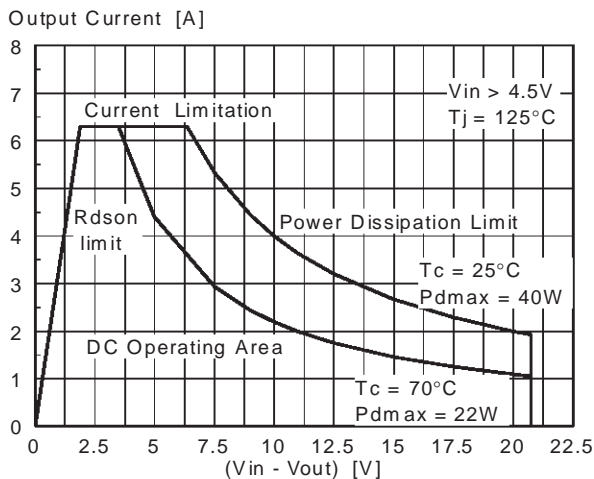

Figure 3: Line Regulation vs. Junction Temperature

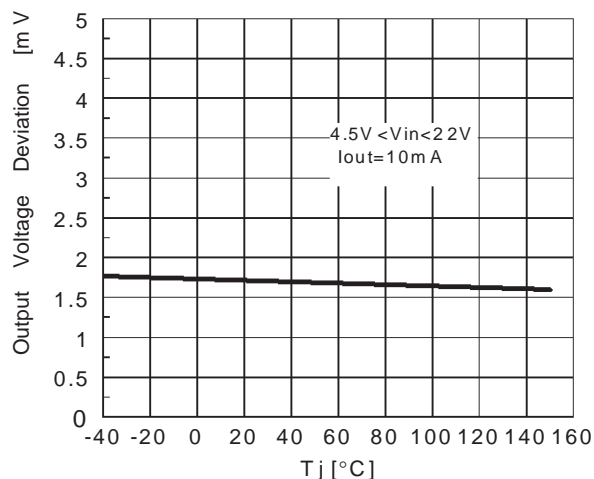

Figure 5: Dropout Voltage

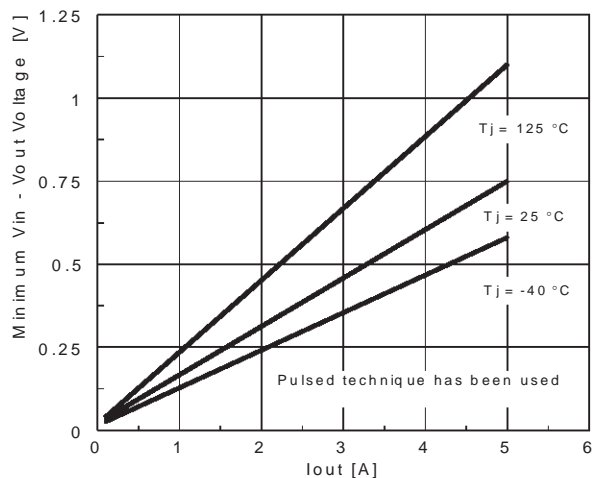

Figure 2: Output Voltage Stability vs. Junction Temperature

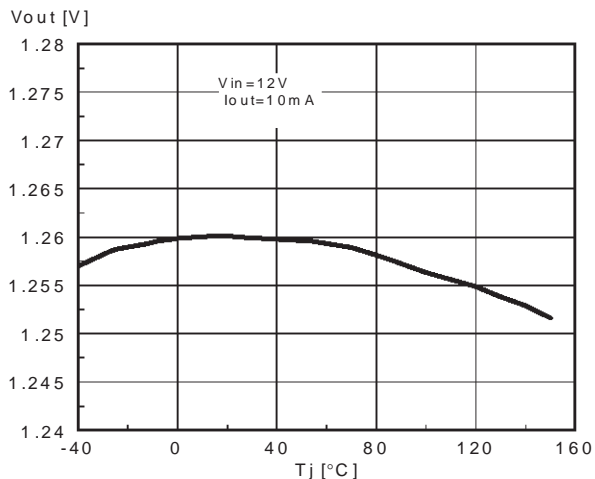

Figure 4: Load Regulation

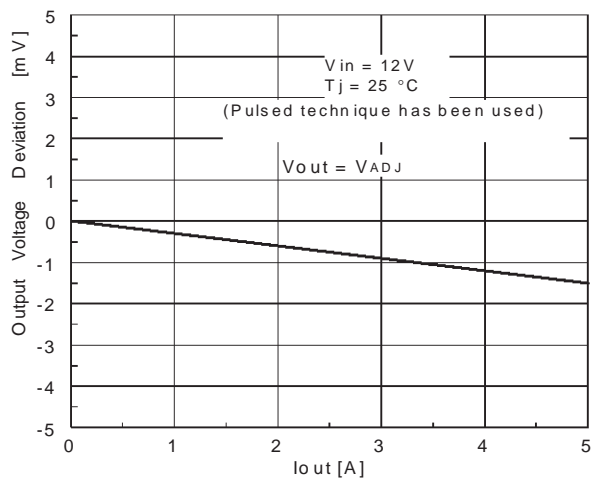
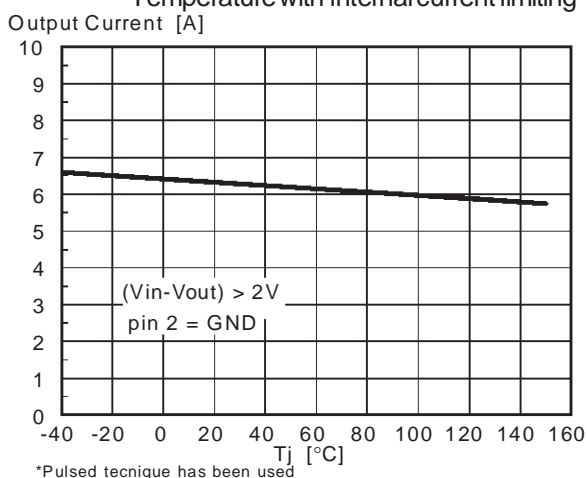

Figure 6: Maximum Output Current vs. Junction Temperature with internal current limiting



L4955

Figure 7: Short-circuit Current vs. Junction Temperature with Programmable Current Limiting

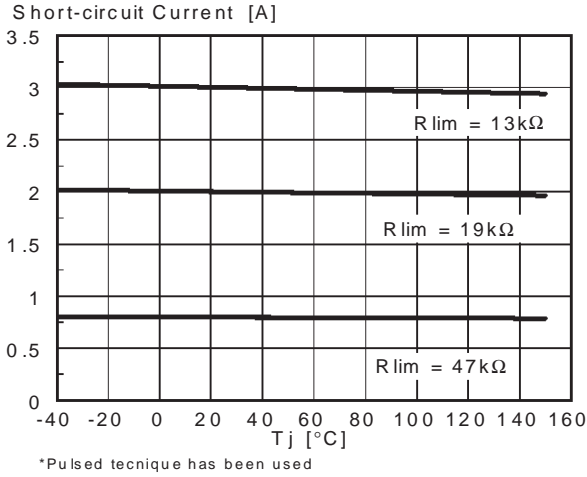

Figure 8: Quiescent Current vs. Temperature (CL = 0V)

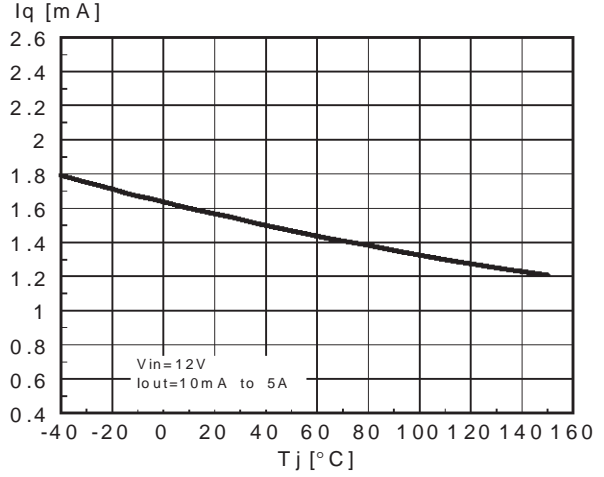

Figure 9: Quiescent Current vs. Supply voltage (CL = 0V)

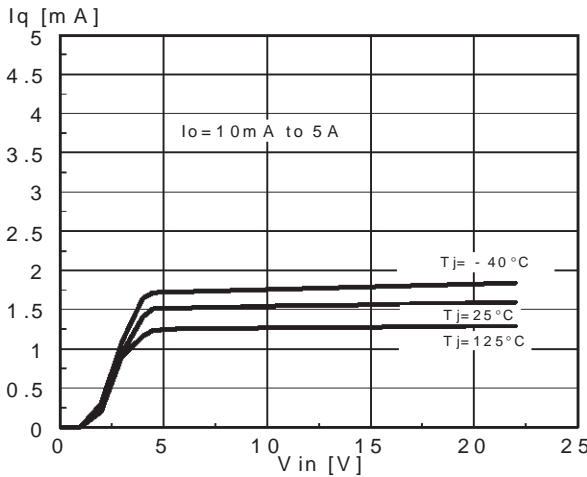

Figure 10: Quiescent Current vs. Supply Voltage with Programmable Current Limiting

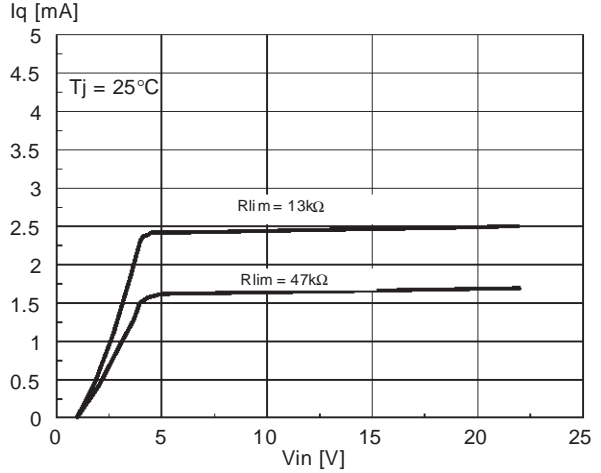

Figure 11: Stand-by Current vs. Supply Voltage with INH = LOGIC HIGH

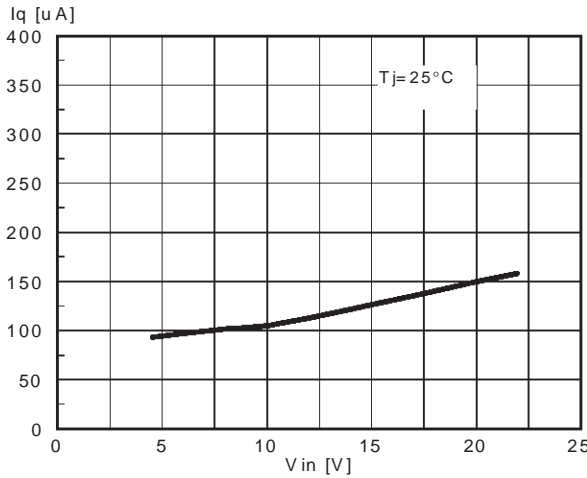
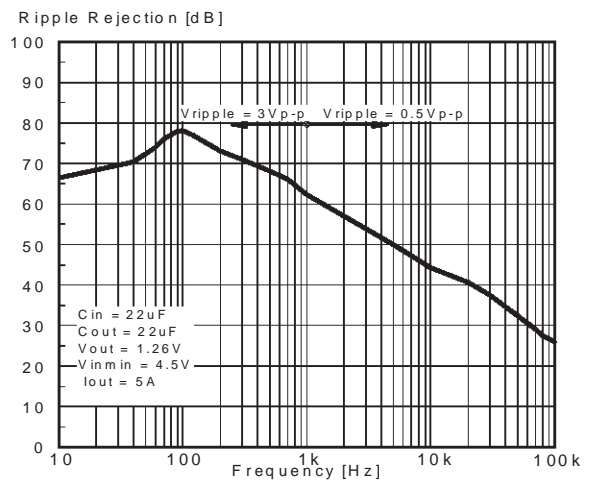

Figure 12: Ripple Rejection vs. Frequency



L4955

Figure 13: Ripple Rejection vs. Output Current

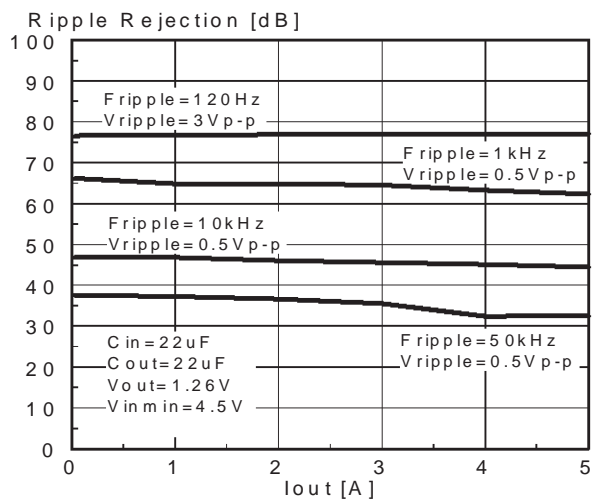

Figure 14: Power Good Function

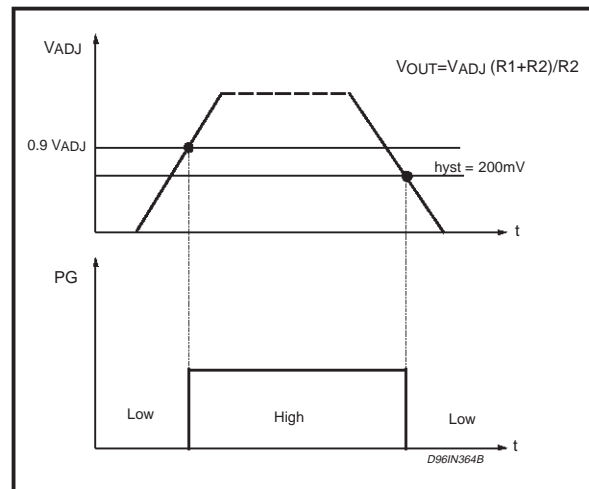
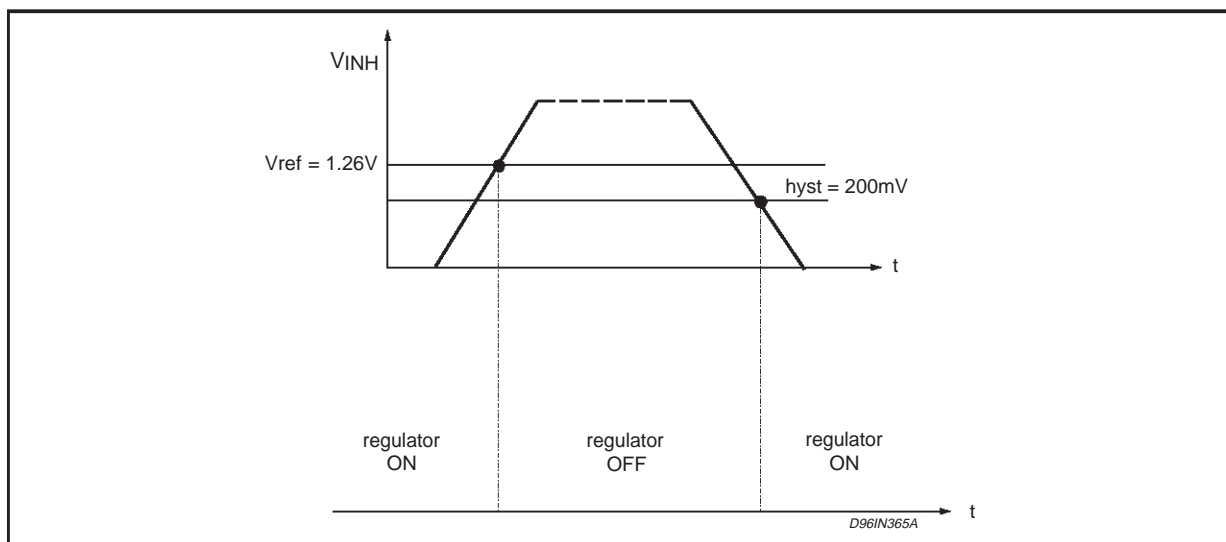

Figure 15: Inhibit Function



LINE TRANSIENT RESPONSE

Figure 16.

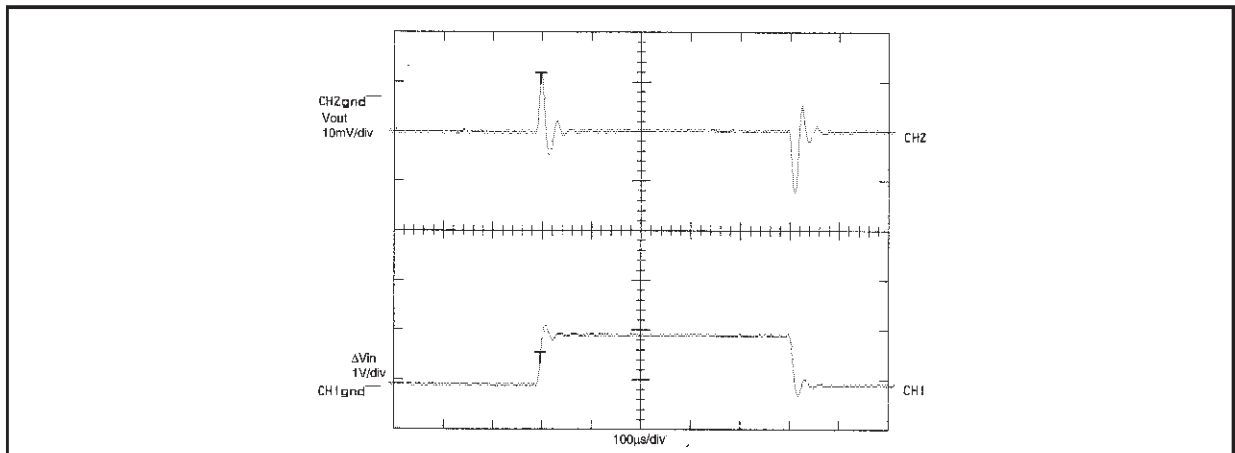

Figure 17.

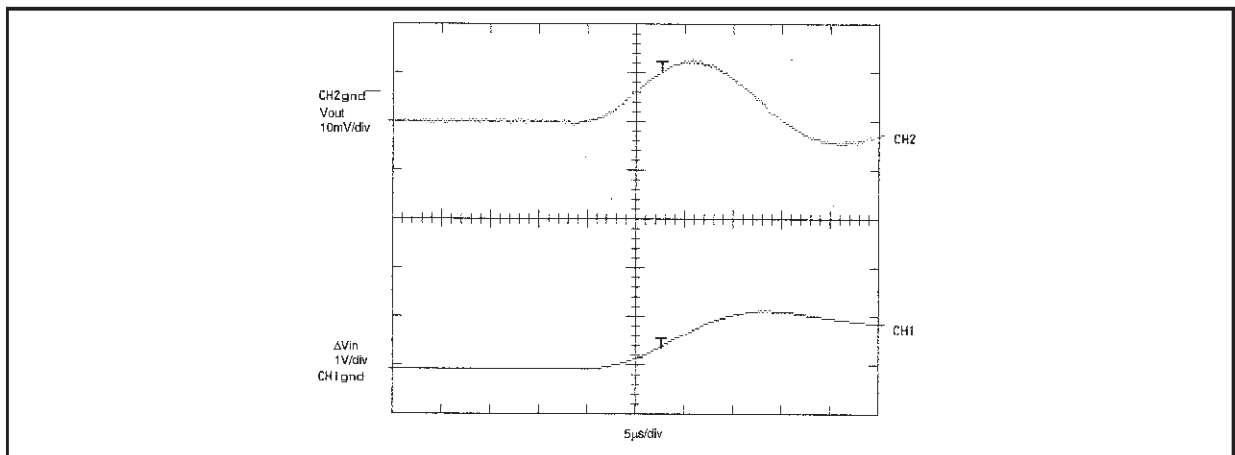
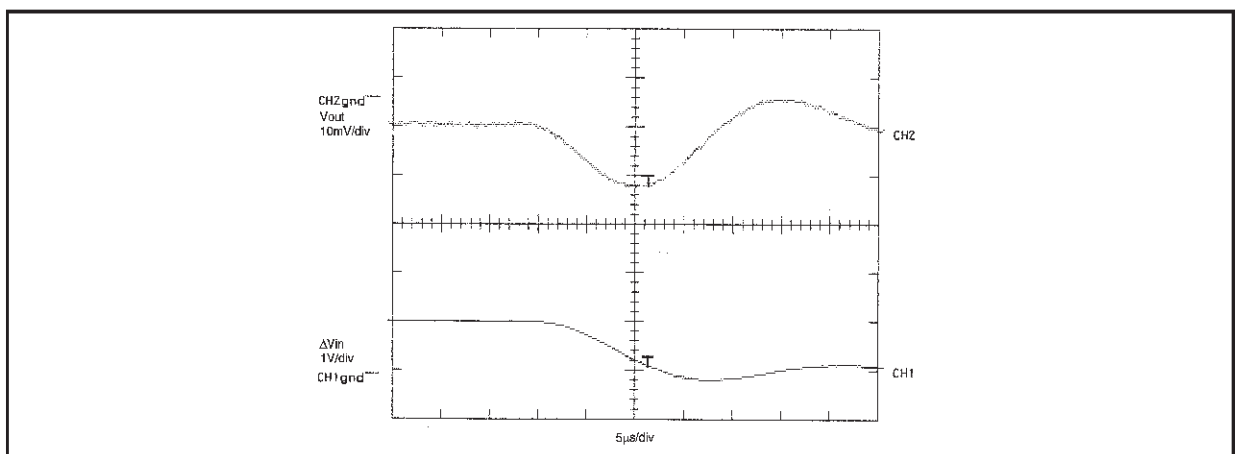

Figure 18.



Test condition: $V_{IN} = 12V$; $\Delta V_{IN} = 1V$; $V_O = 3.3V$; $I_O = 200mA$; $C_{IN} = 10\mu F$ (electrolytic capacitor);
 $C_{out} = 22\mu F$ (electrolytic capacitor); $dV/dt = 0.1 V/\mu s$; $T_J = 25^\circ C$

LOAD TRANSIENT RESPONSE

Figure 19.

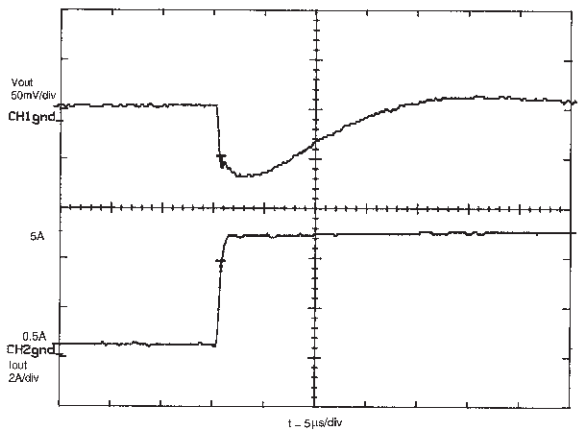

Figure 20.

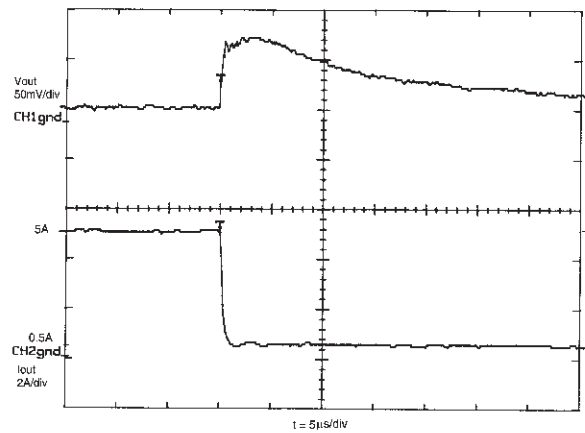
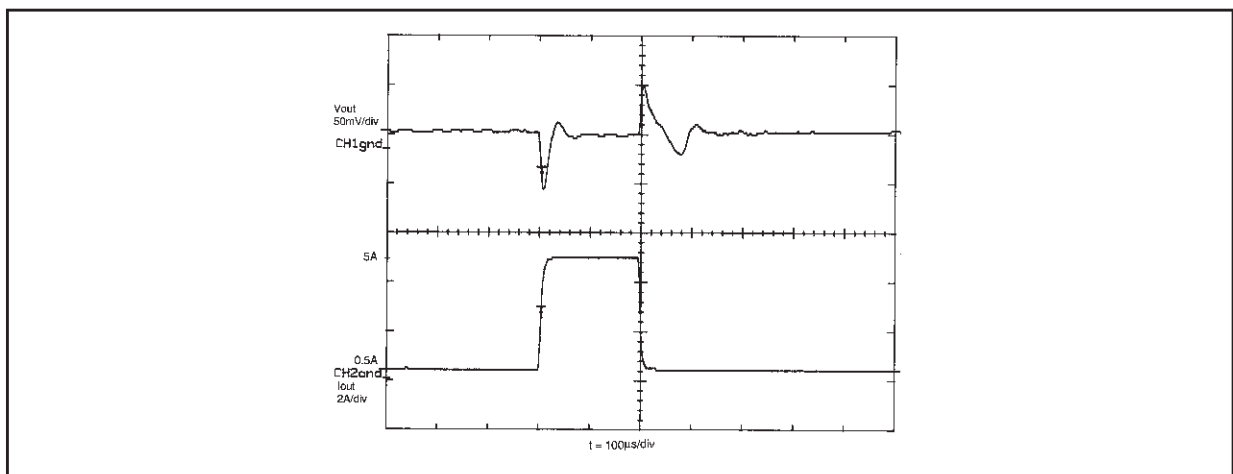
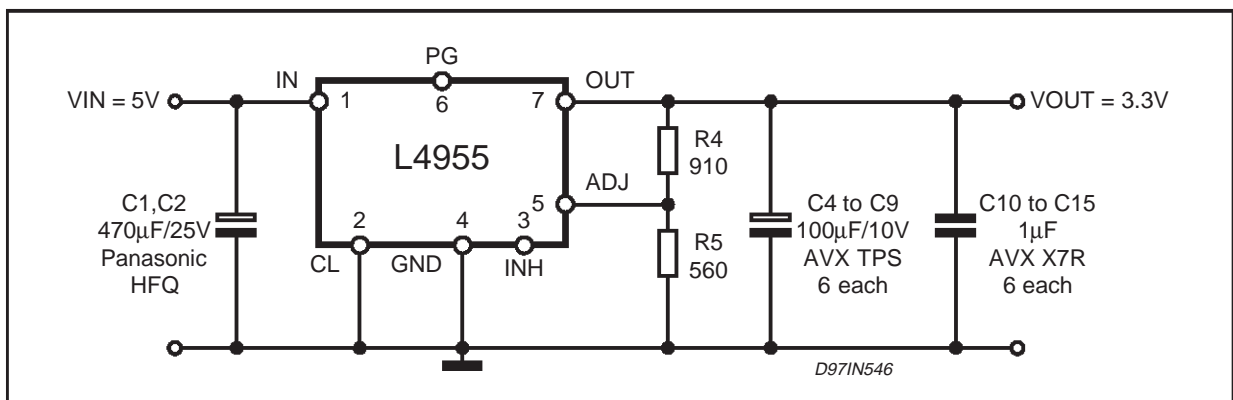

Figure 21.



Test condition: $V_{IN} = 5V$, $V_{OUT} = 3.3V$; Load Transient from 0.5A to 5A; $\frac{dI_{out}}{dt} = 20A/\mu s$; $T_J = 25^\circ C$

Figure 22: Load transient test circuit.



L4955V3.3

Figure 23: DC operating area.

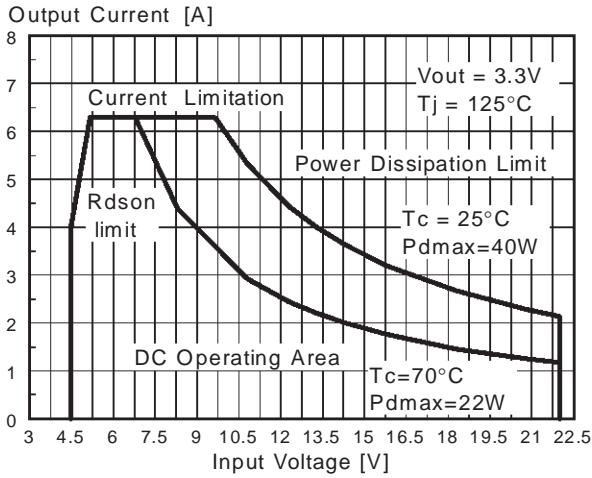

Figure 25: Quiescent Current vs. Temperature.

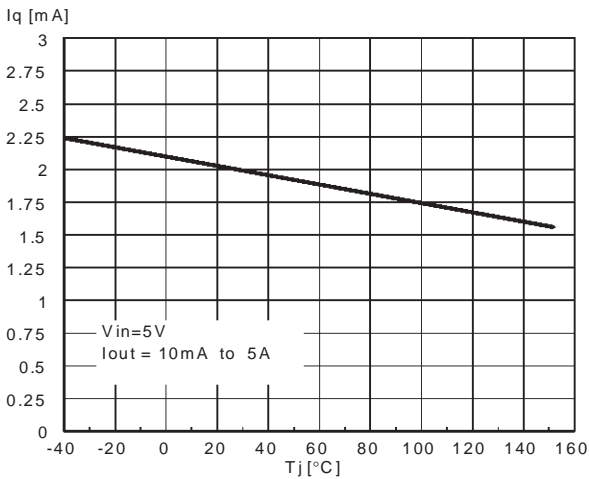

Figure 27: Line regulation vs. Junction Temperature.

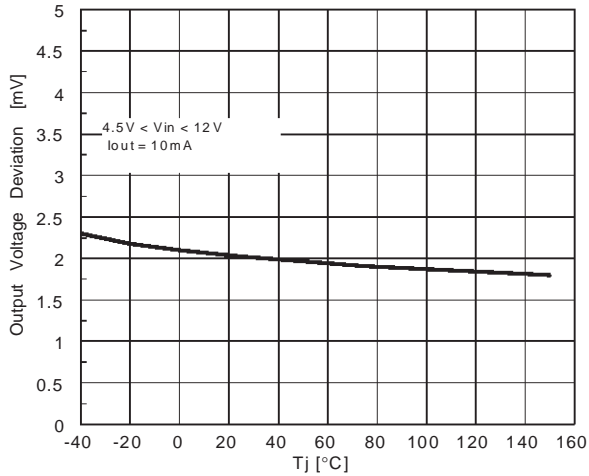

Figure 24: Output Voltage Stability vs. Junction Temperature.

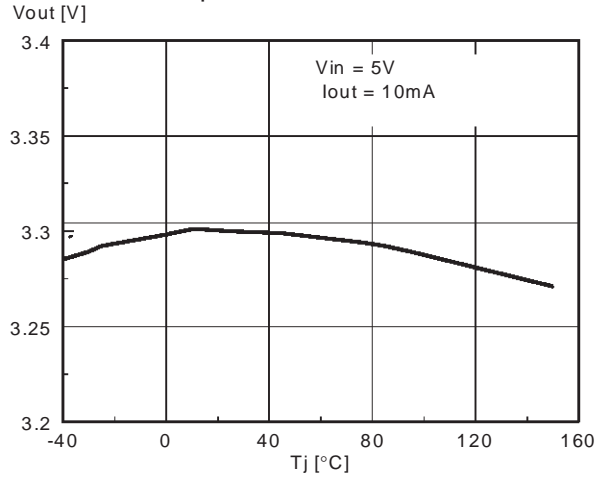

Figure 26: Load Regulation

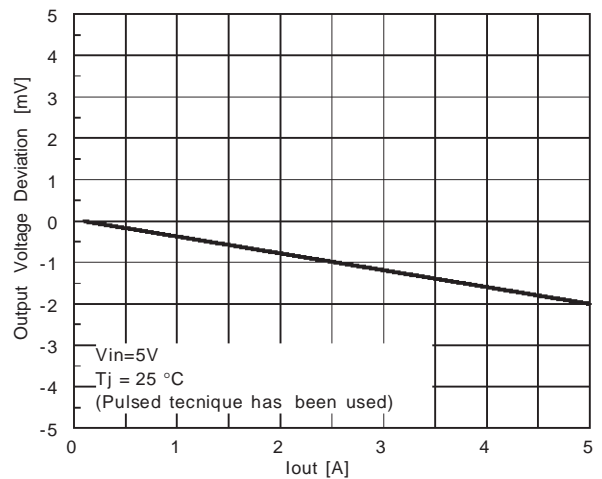
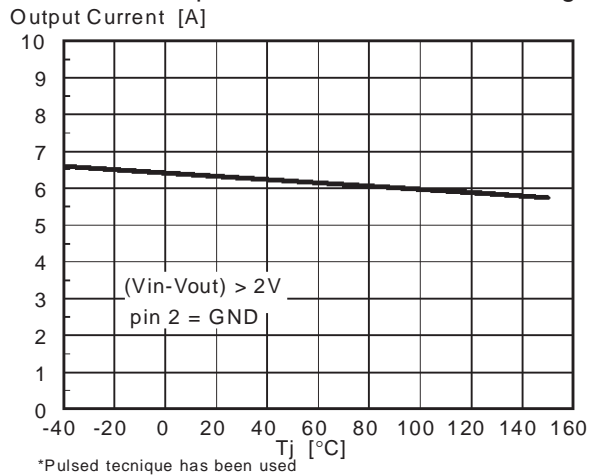

Figure 28: Maximum Output Current vs. Junction Temperature with internal current limiting



*Pulsed technique has been used

L4955V5.1

Figure 29: DC operating area.

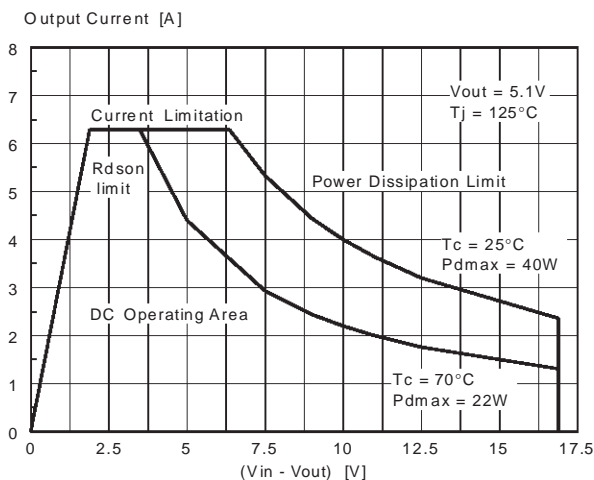

Figure 31: Quiescent Current vs. Temperature.

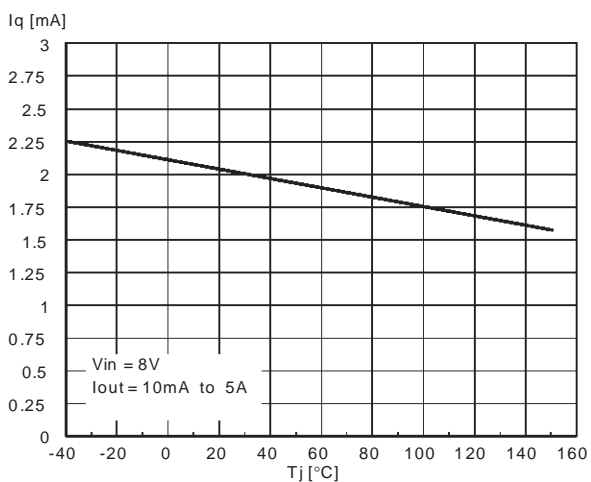

Figure 33: Line regulation vs. Junction Temperature.

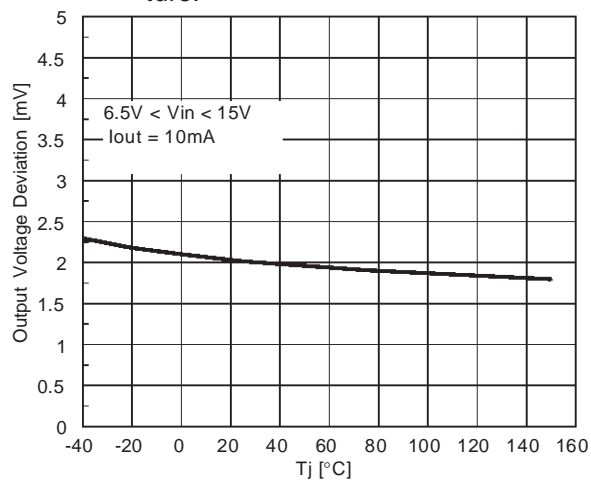

Figure 30: Output Voltage Stability vs. Junction Temperature.

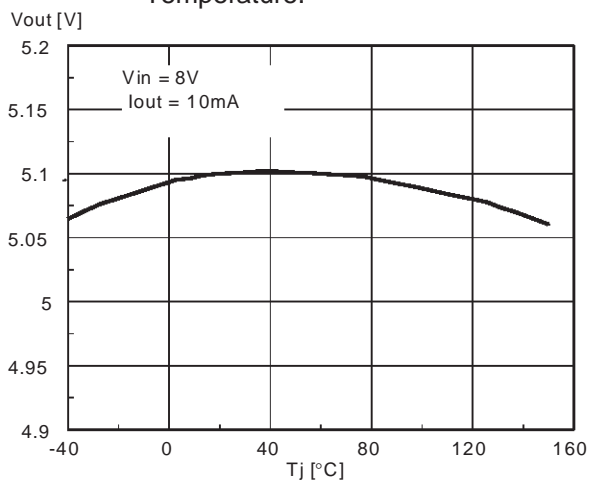

Figure 32: Load Regulation

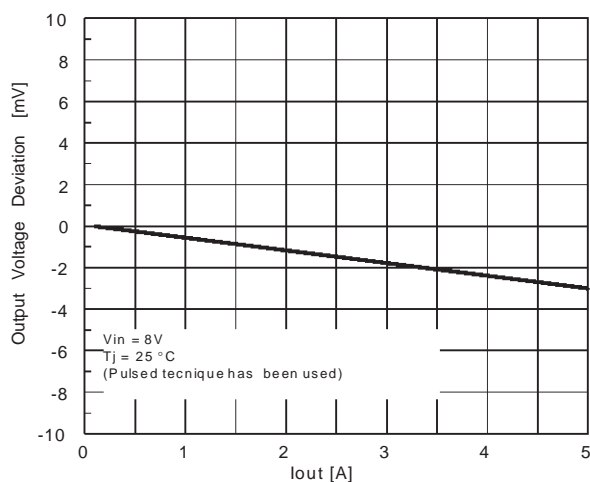
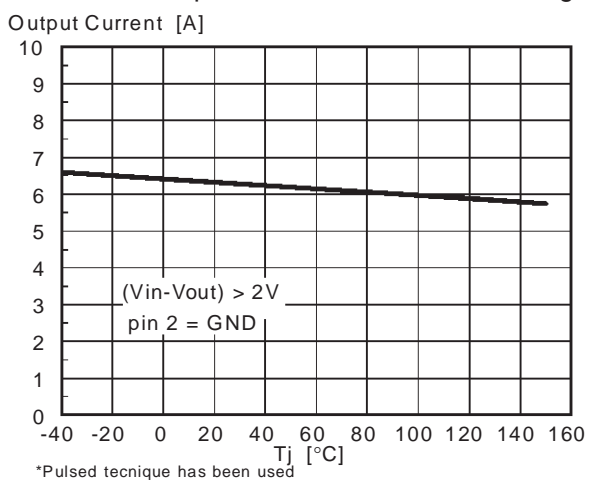
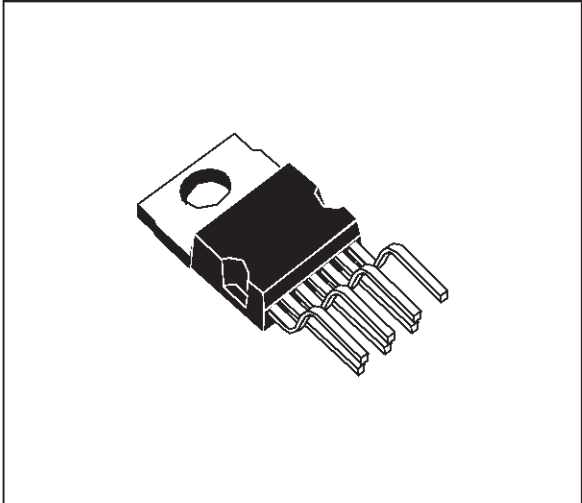

Figure 34: Maximum Output Current vs. Junction Temperature with internal current limiting



DIM.	mm			inch		
	MIN.	TYP.	MAX.	MIN.	TYP.	MAX.
A			4.8			0.189
C			1.37			0.054
D	2.4		2.8	0.094		0.110
D1	1.2		1.35	0.047		0.053
E	0.35		0.55	0.014		0.022
E1	0.7		0.97	0.028		0.038
F	0.6		0.8	0.024		0.031
F1			0.9			0.035
G	2.34	2.54	2.74	0.095	0.100	0.105
G1	4.88	5.08	5.28	0.193	0.200	0.205
G2	7.42	7.62	7.82	0.295	0.300	0.307
H2			10.4			0.409
H3	10.05		10.4	0.396		0.409
L	16.7	16.9	17.1	0.657	0.668	0.673
L1		14.92			0.587	
L2	21.24	21.54	21.84	0.386	0.848	0.860
L3	22.27	22.52	22.77	0.877	0.891	0.896
L4			1.29			0.051
L5	2.6	2.8	3	0.102	0.110	0.118
L6	15.1	15.5	15.8	0.594	0.610	0.622
L7	6	6.35	6.6	0.236	0.250	0.260
L9		0.2			0.008	
M	2.55	2.8	3.05	0.100	0.110	0.120
M1	4.83	5.08	5.33	0.190	0.200	0.210
V4	40° (typ.)					
Dia	3.65		3.85	0.144		0.152

OUTLINE AND MECHANICAL DATA



Heptawatt V

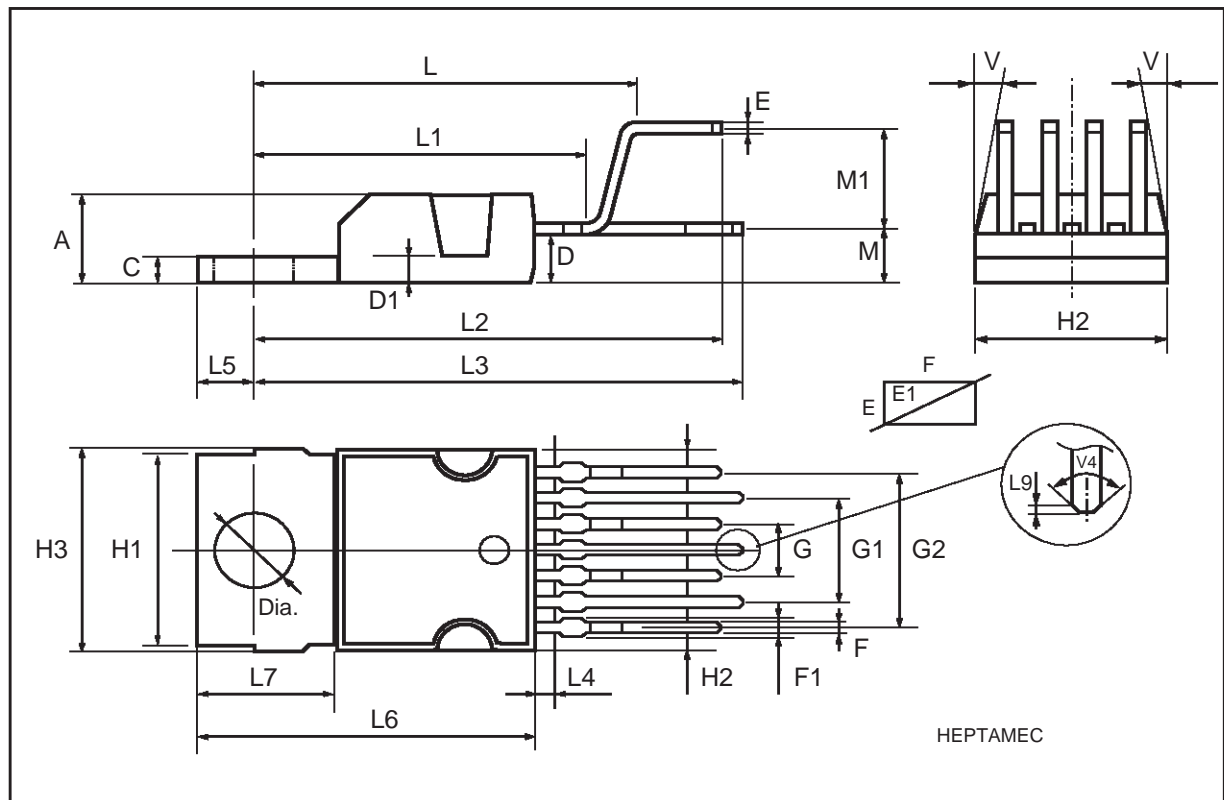

DIM.	mm			inch		
	MIN.	TYP.	MAX.	MIN.	TYP.	MAX.
A	4.40		4.60	0.173		0.181
C	1.23		1.32	0.048		0.051
D	2.40		2.72	0.094		0.107
E	0.49		0.70	0.019		0.027
F	0.61		0.88	0.024		0.034
F1	1.14		1.70	0.044		0.067
F2	1.14		1.70	0.044		0.067
G	4.95		5.15	0.194		0.203
G1	2.40		2.70	0.094		0.106
H2	10.0		10.4	0.393		0.409
L2		16.4			0.645	
L4	13.0		14.0	0.511		0.551
L5	2.65		2.95	0.104		0.116
L6	15.25		15.75	0.600		0.620
L7	6.20		6.60	0.244		0.260
L9	3.50		3.93	0.137		0.154
M		2.6			0.102	
Dia	3.75		3.85	0.147		0.151

OUTLINE AND MECHANICAL DATA

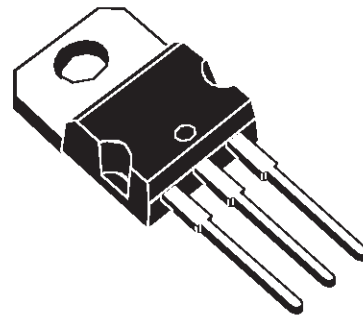

Versawatt (TO220)

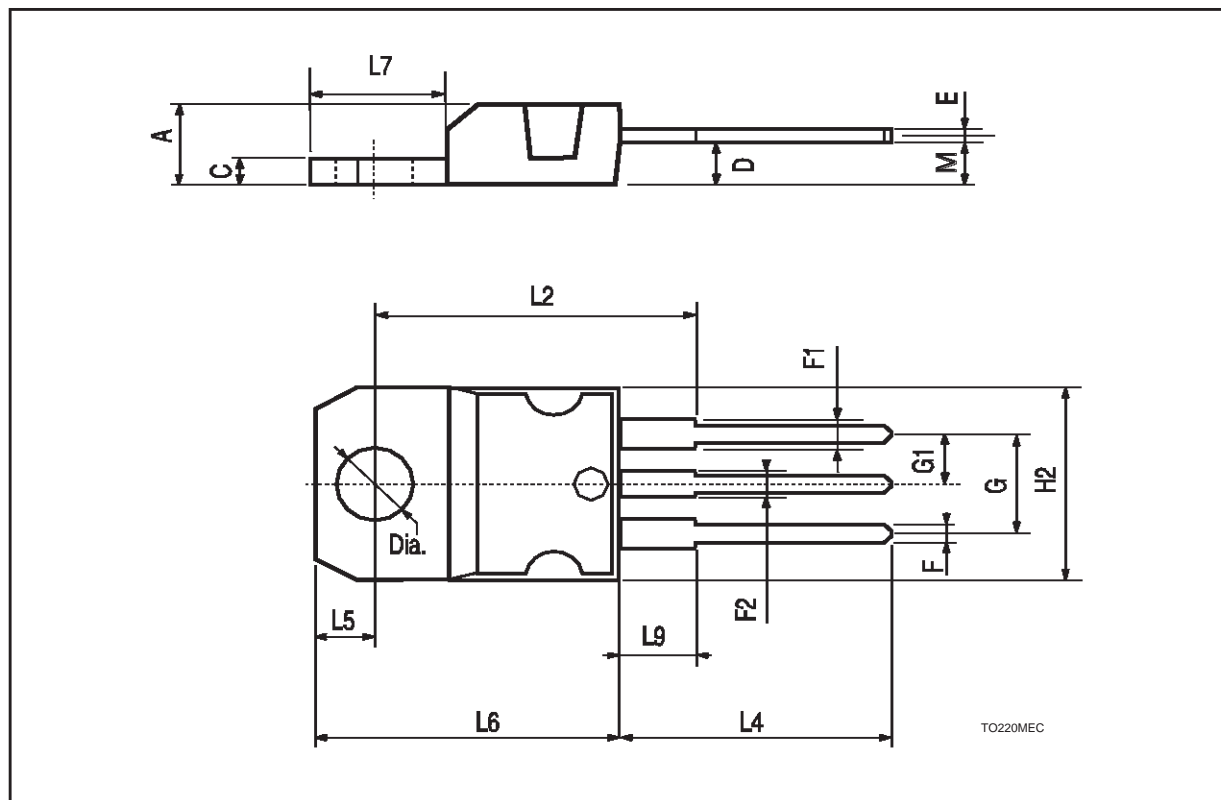

Information furnished is believed to be accurate and reliable. However, STMicroelectronics assumes no responsibility for the consequences of use of such information nor for any infringement of patents or other rights of third parties which may result from its use. No license is granted by implication or otherwise under any patent or patent rights of STMicroelectronics. Specification mentioned in this publication are subject to change without notice. This publication supersedes and replaces all information previously supplied. STMicroelectronics products are not authorized for use as critical components in life support devices or systems without express written approval of STMicroelectronics.

The ST logo is a registered trademark of STMicroelectronics

© 1999 STMicroelectronics – Printed in Italy – All Rights Reserved

STMicroelectronics GROUP OF COMPANIES

Australia - Brazil - Canada - China - France - Germany - Italy - Japan - Korea - Malaysia - Malta - Mexico - Morocco - The Netherlands - Singapore - Spain - Sweden - Switzerland - Taiwan - Thailand - United Kingdom - U.S.A.

<http://www.st.com>