

# μA703

## RF-IF AMPLIFIER

### FAIRCHILD LINEAR INTEGRATED CIRCUITS

**GENERAL DESCRIPTION** — The μA703 is a monolithic RF-IF Amplifier constructed using the Fairchild Planar\* epitaxial process and is intended for use as a limiting or non-limiting amplifier, harmonic mixer, or oscillator to 150 MHz. The low internal feedback of the device insures a higher stability-limited gain than that available from conventional circuitry. Including the biasing network in the same package reduces the number of external components required, thereby increasing the reliability and versatility of the device.

- 29 mmho **MINIMUM FORWARD TRANSADMITTANCE**
- 1.0 mmho/0.05 mmho **MAXIMUM INPUT/OUTPUT CONDUCTANCE**
- 18 pF/4.0 pF **MAXIMUM INPUT/OUTPUT CAPACITANCE**

#### ABSOLUTE MAXIMUM RATINGS

Supply Voltage	20 V
Output Collector Voltage	24 V
Voltage Between Input Terminals	±5.0 V
Internal Power Dissipation	200 mW
Operating Temperature Range (μA703)	-55°C to +125°C
Operating Temperature Range (μA703C)	0°C to +70°C
Storage Temperature Range	-65°C to +150°C
Pin Temperature (Soldering, 10 s)	300°C

**CONNECTION DIAGRAM**  
**8-PIN METAL CAN**  
 (TOP VIEW)  
 PACKAGE OUTLINE 5C  
 PACKAGE CODE H

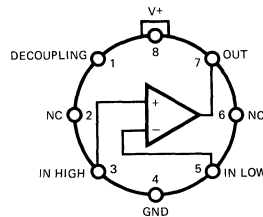

**ORDER INFORMATION**

TYPE	PART NO.
μA703	μA703HM
μA703C	μA703HC

#### EQUIVALENT CIRCUIT

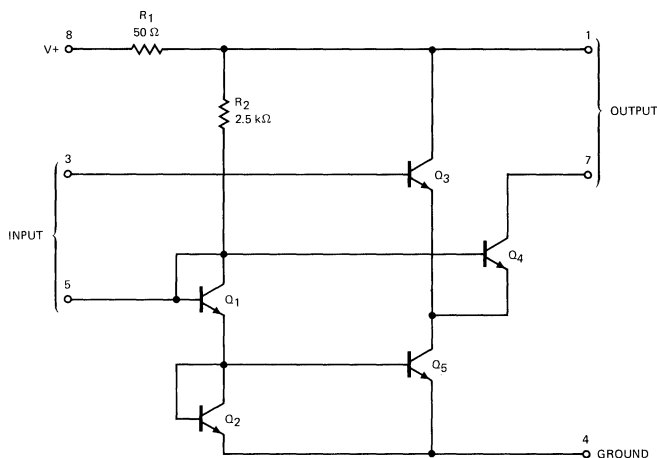

\*Planar is a patented Fairchild process.

FAIRCHILD •  $\mu A703$

$\mu A703$

**ELECTRICAL CHARACTERISTICS:**  $T_A = 25^\circ C$ ,  $V_+ = 12 V$  unless otherwise specified

CHARACTERISTICS	CONDITIONS	MIN	TYP	MAX	UNITS
Power Consumption	$e_{IN} = 0$		110	170	mW
Quiescent Output Current	$e_{IN} = 0$	2.1	2.5	3.1	mA
Peak-to-Peak Output Current	$e_{IN} = 400 \text{ mV rms, } f = 1 \text{ kHz}$	4.0			mA
Output Saturation Voltage				1.7	V
Forward Transadmittance	$e_{IN} = 10 \text{ mV rms } f \leq 1 \text{ kHz}$	29	35		mmbo
Input Conductance	$e_{IN} < 10 \text{ mV rms, } f \leq 5 \text{ MHz}$		0.30	0.43	mmbo
Input Capacitance	$e_{IN} < 10 \text{ mV rms, } f \leq 5 \text{ MHz}$		7.0	16.0	pF
Output Capacitance	$f \leq 5 \text{ MHz}$		2.0	3.0	pF
Output Conductance	$e_O \leq 100 \text{ mV rms, } f \leq 5 \text{ MHz}$		0.02	0.04	mmbo
The following specifications apply for $-55^\circ C \leq T_A \leq +125^\circ C$					
Quiescent Output Current	$e_{IN} = 0$	1.7		3.1	mA
Peak-to-Peak Output Current	$e_{IN} = 400 \text{ mV rms, } f = 1 \text{ kHz}$	3.2			mA
Output Saturation Voltage				1.8	V
Forward Transadmittance	$e_{IN} = 10 \text{ mV rms, } f \leq 1 \text{ kHz}$	21			mmbo
Input Conductance	$e_{IN} < 10 \text{ mV rms, } f \leq 5 \text{ MHz}$			1.2	mmbo
Output Conductance	$e_O \leq 100 \text{ mV rms, } f \leq 5 \text{ MHz}$			0.05	mmbo

$\mu A703C$

**ELECTRICAL CHARACTERISTICS:**  $T_A = 25^\circ C$ ,  $V_+ = 12 V$  unless otherwise specified)

CHARACTERISTICS	CONDITIONS	MIN.	TYP.	MAX.	UNITS
Supply Current	$e_{IN} = 0$		9.0	14	mA
Power Consumption	$e_{IN} = 0$		110	170	mW
Quiescent Output Current	$e_{IN} = 0$	1.5	2.5	3.3	mA
Peak-to-Peak Output Current	$e_{IN} = 400 \text{ mV rms, } f = 1 \text{ kHz}$	3.0			mA
Output Saturation Voltage	$I_7 = 2.5 \text{ mA}$			1.7	V
Forward Transadmittance	$e_{IN} = 10 \text{ mV rms, } f = 1 \text{ kHz}$	29	33		mmho
Input Conductance	$e_{IN} < 10 \text{ mV rms, } f = 10.7 \text{ MHz}$		0.35	1.0	mmho
Input Capacitance	$e_{IN} < 10 \text{ mV rms, } f = 10.7 \text{ MHz}$		9.0	18	pF
Output Conductance	$e_{OUT} = 100 \text{ mV rms, } f = 10.7 \text{ MHz}$		0.03	0.05	mmho
Output Capacitance	$e_{OUT} = 100 \text{ mV rms, } f = 10.7 \text{ MHz}$		2.0	4.0	pF
Noise Figure	$f = 10.7 \text{ MHz, } R_S = 500 \Omega$		6.0		dB
	$f = 100 \text{ MHz, } R_S = 500 \Omega$		8.0		dB

TYPICAL PERFORMANCE CURVES FOR  $\mu A703$

INPUT RESISTANCE AND CAPACITANCE AS A FUNCTION OF INPUT VOLTAGE

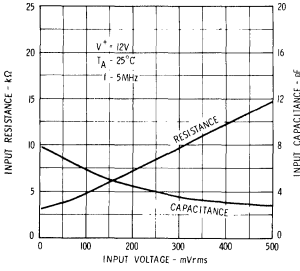

INPUT ADMITTANCE AS A FUNCTION OF FREQUENCY

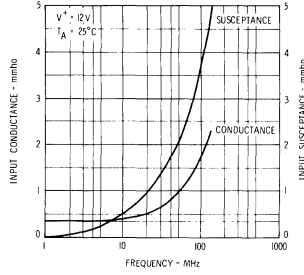

OUTPUT ADMITTANCE AS A FUNCTION OF FREQUENCY

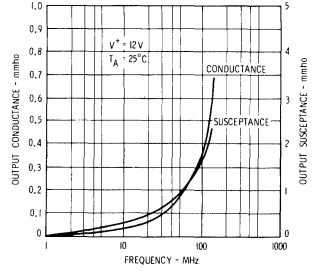

FORWARD TRANSMITTANCE AS A FUNCTION OF FREQUENCY

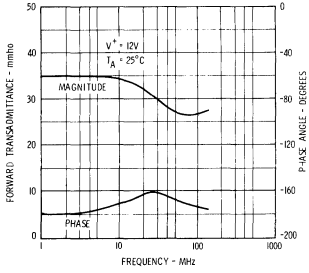

MAXIMUM REVERSE TRANSMITTANCE AS A FUNCTION OF FREQUENCY

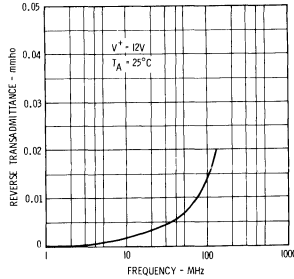

OUTPUT CURRENT AS A FUNCTION OF INPUT VOLTAGE

