

TL601, TL604, TL607, TL610 P-MOS ANALOG SWITCHES

SLAS042 – D2161, JUNE 1976 — REVISED OCTOBER 1986

- Switch ± 10 -V Analog Signals
- TTL Logic Capability
- 5-to 30-V Supply Ranges
- Low (100Ω) On-State Resistance
- High ($10^{11} \Omega$) Off-State Resistance
- 8-Pin Functions

description

The TL601, TL604, TL607, and TL610 are a family of monolithic P-MOS analog switches that provide fast switching speeds with high r_{off}/r_{on} ratio and no offset voltage. The p-channel enhancement-type MOS switches accept analog signals up to ± 10 V and are controlled by TTL-compatible logic inputs. The monolithic structure is made possible by BI-MOS technology, which combines p-channel MOS with standard bipolar transistors.

These switches are particularly useful in military, industrial, and commercial applications such as data acquisition, multiplexers, A/D and D/A converters, MODEMS, sample-and-hold systems, signal multiplexing, integrators, programmable operational amplifiers, programmable voltage regulators, crosspoint switching networks, logic interface, and many other analog systems.

The TL601 is an SPDT switch with two logic control inputs. The TL604 is a dual complementary SPST switch with a single control input. The TL607 is an SPDT switch with one logic control input and one enable input. The TL610 is an SPST switch with three logic control inputs. The TL610 features a higher r_{off}/r_{on} ratio than the other members of the family.

The TL601C, TL604C, TL607C, and TL610C are characterized for operation from 0°C to 70°C , the TL601I, TL604I, TL607I, and TL610I are characterized for operation from -25°C to 85°C , and the TL601M, TL604M, TL607M, and TL610M are characterized for operation over the full military temperature range of -55°C to 125°C .

JG OR P PACKAGE (TOP VIEW)

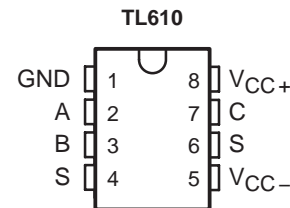
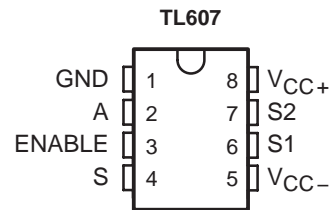
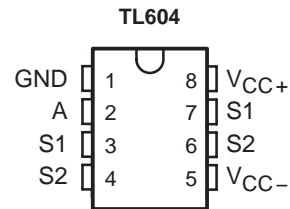
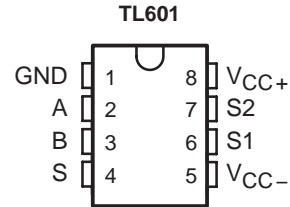

schematics of inputs and outputs

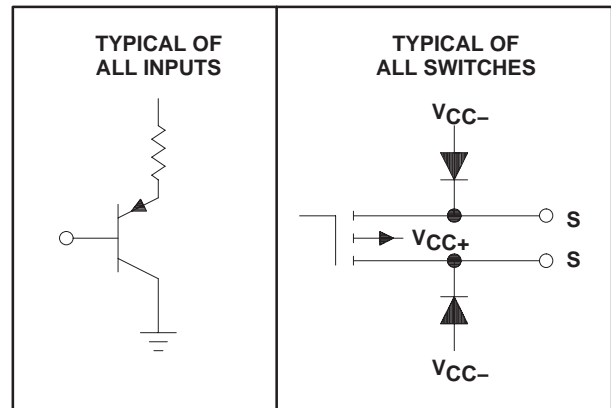

TL601, TL604, TL607, TL610 P-MOS ANALOG SWITCHES

D2161, JUNE 1976 — REVISED OCTOBER 1986

logic symbols† and switch diagrams

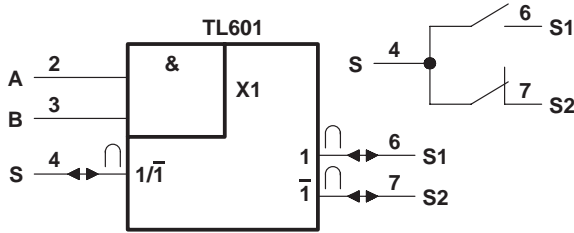

FUNCTION TABLE

INPUTS		ANALOG SWITCHES	
A	B	S1	S2
L	X	Off (open)	On (closed)
X	L	Off (open)	On (closed)
H	H	On (closed)	Off (open)

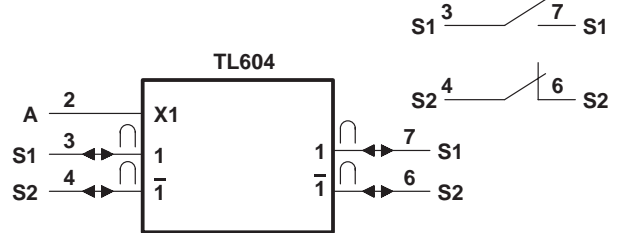

FUNCTION TABLE

INPUT	ANALOG SWITCHES	
A	S1	S2
H	On (closed)	Off (open)
L	Off (open)	On (closed)

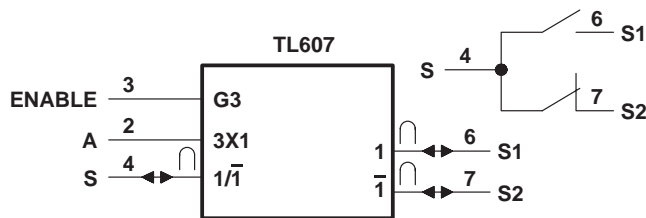

FUNCTION TABLE

INPUTS		ANALOG SWITCHES	
A	ENABLE	S1	S2
X	L	Off (open)	Off (open)
L	H	Off (open)	On (closed)
H	H	On (closed)	Off (open)

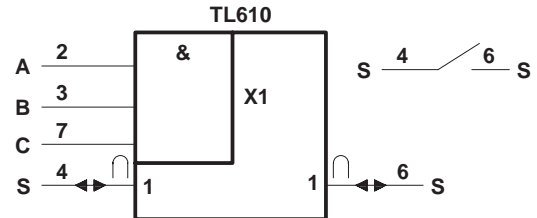

FUNCTION TABLE

INPUTS			ANALOG SWITCHES
A	B	C	S
L	X	X	Off (open)
X	L	X	Off (open)
X	X	L	Off (open)
X	H	H	On (closed)

† These symbols are in accordance with ANSI/IEEE Std 91-1984.

TL607 logic diagram (positive logic)

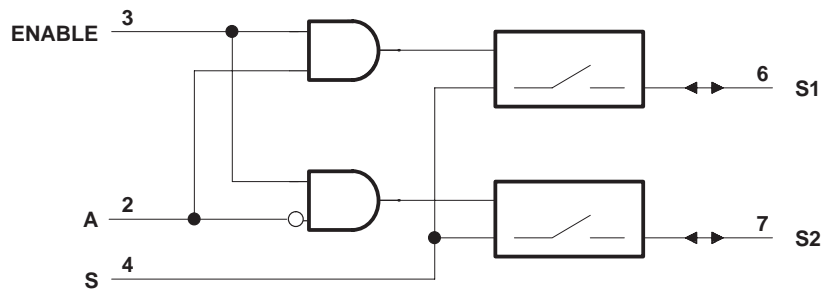

TL601, TL604, TL607, TL610 P-MOS ANALOG SWITCHES

D2161, JUNE 1976 — REVISED OCTOBER 1986

absolute maximum ratings over operating free-air temperature range (unless otherwise noted)

Supply voltage, V_{CC+} (see Note 1)	30 V
Supply voltage, V_{CC-}	-30 V
V_{CC+} to V_{CC-} supply voltage differential	35 V
Control input voltage	V_{CC+}
Switch off-state voltage	30 V
Switch on-state current	10 mA
Operating free-air temperature range:	
TL601C, TL604C, TL607C, TL610C	0°C to 70°C
TL601I, TL604I, TL607I, TL610I	-25°C to 85°C
TL601M, TL604M, TL607M, TL610M	-55°C to 125°C
Storage temperature range	-65°C to 150°C
Lead temperature (1,6 mm) 1/16 inch from case for 60 seconds: JG package	300°C
Lead temperature (1,6 mm) 1/16 inch from case for 10 seconds: P package	260°C

NOTE 1: All voltage values are with respect to network ground terminal.

recommended operating conditions

	TL601C, TL604C TL607C, TL610C			TL601I, TL604I TL607I, TL610I			TL601M, TL604M TL607M, TL610M			UNIT
	MIN	TYP	MAX	MIN	TYP	MAX	MIN	TYP	MAX	
Supply voltage, V_{CC+} (see Figure 1)	5	10	25	5	10	25	5	10	25	V
Supply voltage, V_{CC-} (see Figure 1)	-5	-20	-25	-5	-20	-25	-5	-20	-25	V
V_{CC+} to V_{CC-} supply voltage differential (see Figure 1)	15		30	15		30	15		30	V
High-level control input voltage, V_{IH}	2		5.5	2		5.5	2		5.5	V
Low-level control input voltage, V_{IL}	All inputs			0.8			0.8			
Voltage at any analog switch (S) terminal	$V_{CC-} + 8$		V_{CC+}	$V_{CC-} + 8$		V_{CC+}	$V_{CC-} + 8$		V_{CC+}	V
Switch on-state current	10			10			10			mA
Operating free-air temperature, T_A	0		70	25		85	-55		125	°C



TL601, TL604, TL607, TL610 P-MOS ANALOG SWITCHES

D2161, JUNE 1976 — REVISED OCTOBER 1986

electrical characteristics over recommended operating free-air temperature range, $V_{CC+} = 10\text{ V}$, $V_{CC-} = -20\text{ V}$, analog switch test current = 1 mA (unless otherwise noted)

PARAMETER	TEST CONDITIONS†	TL6 __ C			TL6 __ M TL6 __ I			UNIT		
		MIN	TYP‡	MAX	MIN	TYP‡	MAX			
I_{IH} High-level input current	$V_I = 5.5\text{ V}$		0.5	10		0.5	10	μA		
I_{IL} Low-level input current	$V_I = 0.4\text{ V}$		-50	-250		-50	-250	μA		
I_{off} Switch off-state current	$V_{I(sw)} = -10\text{ V}$, See Note 2	$T_A = 25^\circ\text{C}$		-500		-400		pA		
		$T_A = \text{MAX}^\dagger$		-10	-20		-50	-100	nA	
r_{on} Switch on-state resistance	$V_{I(sw)} = 10\text{ V}$, $I_{O(sw)} = -1\text{ mA}$	TL601 TL604 TL607		75	200		55	100	Ω	
		TL610		40	100		40	80		
	$V_{I(sw)} = -10\text{ V}$, $I_{O(sw)} = -1\text{ mA}$	TL601 TL604 TL607		220	600		220	400		
		TL610		120	300		120	300		
r_{off} Switch off-state resistance			20		20		$\text{G}\Omega$			
C_{on} Switch on-state input capacitance	$V_{I(sw)} = 0\text{ V}$, $f = 1\text{ MHz}$		16		16		pF			
C_{off} Switch off-state input capacitance	$V_{I(sw)} = 0\text{ V}$, $f = 1\text{ MHz}$		8		8		pF			
I_{CC+} Supply current from V_{CC+}	Logic input(s) at 5.5 V, All switch terminals open	TL601 TL604		5	10		5	10	mA	
		TL607	ENABLE high		5	10		5		10
			ENABLE low		3	5		3		5
		TL610		5	10		5	10		
I_{CC-} Supply current from V_{CC-}	Logic input(s) at 5.5 V, All switch terminals open	TL601 TL604		-1.2	-2.5		-1.2	-2.5	mA	
		TL607	ENABLE high		-2.5	-5		-2.5		-5
			ENABLE low		-0.05	-0.5		-0.05		-0.5
		TL610		-1.2	-2.5		-1.2	-2.5		

† MAX is 70°C for C-suffix types, 85°C for I-suffix types, and 125°C for M-suffix types.

‡ All typical values are at $T_A = 25^\circ\text{C}$ except for I_{off} at $T_A = \text{MAX}$.

NOTE 2: The other terminal of the switch under test is at $V_{CC+} = 10\text{ V}$.

switching characteristics, $V_{CC+} = 10\text{ V}$, $V_{CC-} = -20\text{ V}$, $T_A = 25^\circ\text{C}$

PARAMETER	TEST CONDITIONS	MIN	TYP	MAX	UNIT
t_{off} Switch turn-off time	$R_L = 1\text{ k}\Omega$, $C_L = 35\text{ pF}$, See Figure 2		400	500	ns
t_{on} Switch turn-on time			100	150	



PARAMETER MEASUREMENT INFORMATION

Figure 1 shows power supply boundary conditions for proper operation of the TL601 Series. The range of operation for supply V_{CC+} from 5 V to 25 V is shown on the vertical axis. The range of V_{CC-} from -5 V to -25 V is shown on the horizontal axis. A recommended 30-V maximum voltage differential from V_{CC+} to V_{CC-} governs the maximum V_{CC+} for a chosen V_{CC-} (or vice versa). A minimum recommended difference of 15 V from V_{CC+} to V_{CC-} and the boundaries shown in Figure 1 allow the designer to select the proper combinations of the two supplies.

The designer-selected V_{CC+} supply value for a chosen V_{CC-} supply value limits the maximum input voltage that can be applied to either switch terminal; that is, the input voltage should be between $V_{CC-} + 8$ V and V_{CC+} to keep the on-state resistance within specified limits.

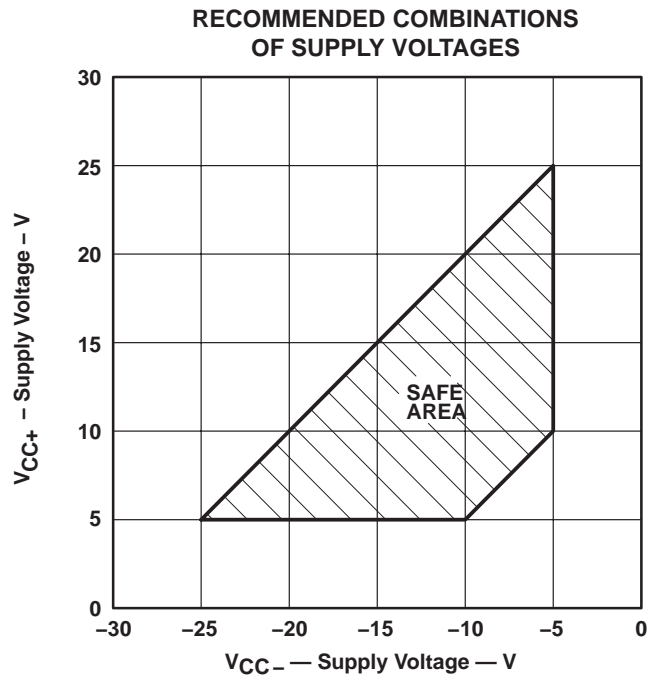
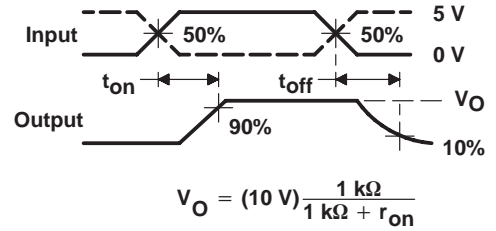
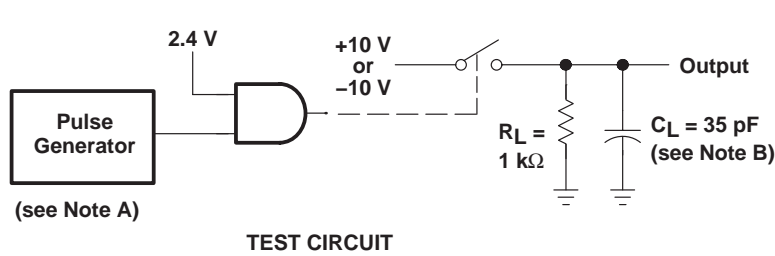

Figure 1

TL601, TL604, TL607, TL610 P-MOS ANALOG SWITCHES

D2161, JUNE 1976 — REVISED OCTOBER 1986

PARAMETER MEASUREMENT INFORMATION



NOTES: A. The pulse generator has the following characteristics: $Z_O = 50\ \Omega$, $t_r \geq 15\text{ ns}$, $t_f \geq 15\text{ ns}$, $t_w = 500\text{ ns}$.
B. C_L includes probe and jig capacitance.

Figure 2

TYPICAL CHARACTERISTICS

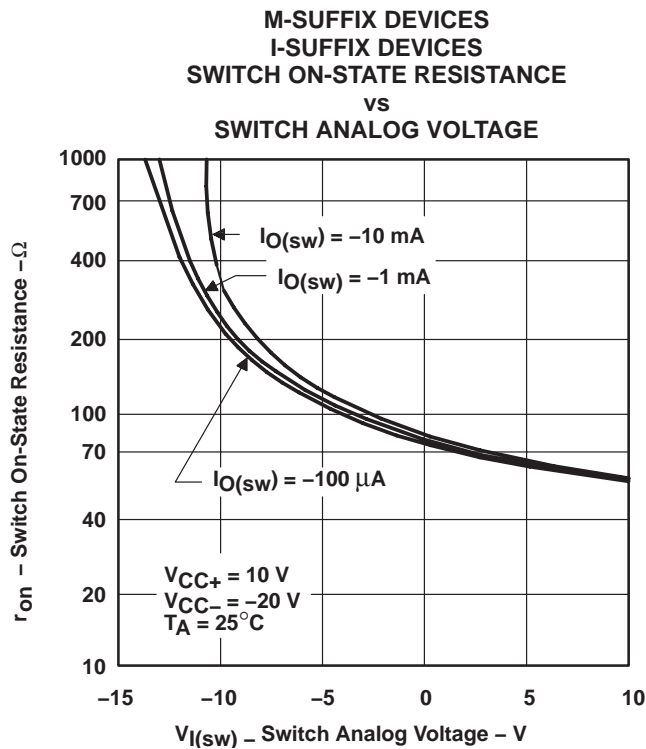

Figure 3

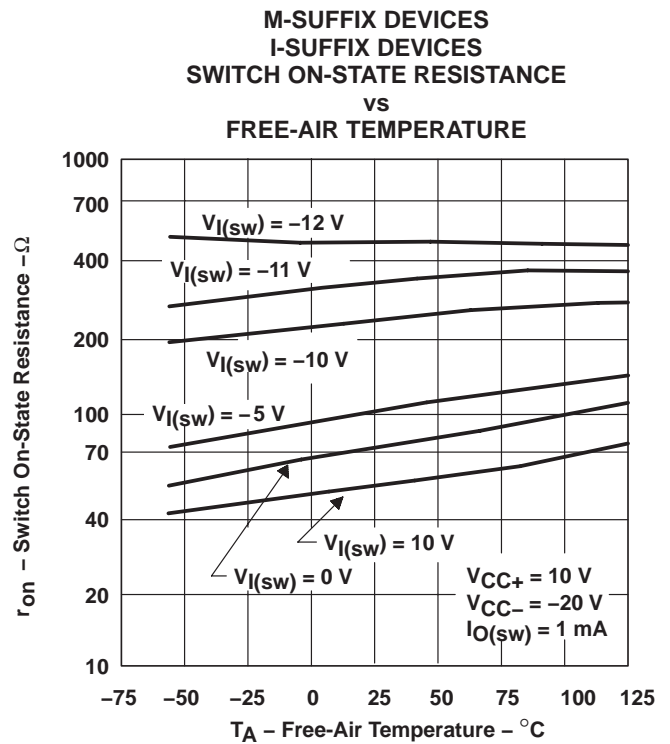

Figure 4

PACKAGING INFORMATION

Orderable Device	Status ⁽¹⁾	Package Type	Package Drawing	Pins	Package Qty	Eco Plan ⁽²⁾	Lead/Ball Finish	MSL Peak Temp ⁽³⁾
TL601CP	OBSOLETE	PDIP	P	8		TBD	Call TI	Call TI
TL601IP	OBSOLETE	PDIP	P	8		TBD	Call TI	Call TI
TL604CP	OBSOLETE	PDIP	P	8		TBD	Call TI	Call TI
TL607CP	OBSOLETE	PDIP	P	8		TBD	Call TI	Call TI
TL610CP	OBSOLETE	PDIP	P	8		TBD	Call TI	Call TI

⁽¹⁾ The marketing status values are defined as follows:

ACTIVE: Product device recommended for new designs.

LIFEBUY: TI has announced that the device will be discontinued, and a lifetime-buy period is in effect.

NRND: Not recommended for new designs. Device is in production to support existing customers, but TI does not recommend using this part in a new design.

PREVIEW: Device has been announced but is not in production. Samples may or may not be available.

OBSOLETE: TI has discontinued the production of the device.

⁽²⁾ Eco Plan - The planned eco-friendly classification: Pb-Free (RoHS) or Green (RoHS & no Sb/Br) - please check <http://www.ti.com/productcontent> for the latest availability information and additional product content details.

TBD: The Pb-Free/Green conversion plan has not been defined.

Pb-Free (RoHS): TI's terms "Lead-Free" or "Pb-Free" mean semiconductor products that are compatible with the current RoHS requirements for all 6 substances, including the requirement that lead not exceed 0.1% by weight in homogeneous materials. Where designed to be soldered at high temperatures, TI Pb-Free products are suitable for use in specified lead-free processes.

Green (RoHS & no Sb/Br): TI defines "Green" to mean Pb-Free (RoHS compatible), and free of Bromine (Br) and Antimony (Sb) based flame retardants (Br or Sb do not exceed 0.1% by weight in homogeneous material)

⁽³⁾ MSL, Peak Temp. -- The Moisture Sensitivity Level rating according to the JEDEC industry standard classifications, and peak solder temperature.

Important Information and Disclaimer:The information provided on this page represents TI's knowledge and belief as of the date that it is provided. TI bases its knowledge and belief on information provided by third parties, and makes no representation or warranty as to the accuracy of such information. Efforts are underway to better integrate information from third parties. TI has taken and continues to take reasonable steps to provide representative and accurate information but may not have conducted destructive testing or chemical analysis on incoming materials and chemicals. TI and TI suppliers consider certain information to be proprietary, and thus CAS numbers and other limited information may not be available for release.

In no event shall TI's liability arising out of such information exceed the total purchase price of the TI part(s) at issue in this document sold by TI to Customer on an annual basis.

P (R-PDIP-T8)

PLASTIC DUAL-IN-LINE PACKAGE



4040082/E 04/2010

- NOTES:
- A. All linear dimensions are in inches (millimeters).
 - B. This drawing is subject to change without notice.
 - C. Falls within JEDEC MS-001 variation BA.

IMPORTANT NOTICE

Texas Instruments Incorporated and its subsidiaries (TI) reserve the right to make corrections, modifications, enhancements, improvements, and other changes to its products and services at any time and to discontinue any product or service without notice. Customers should obtain the latest relevant information before placing orders and should verify that such information is current and complete. All products are sold subject to TI's terms and conditions of sale supplied at the time of order acknowledgment.

TI warrants performance of its hardware products to the specifications applicable at the time of sale in accordance with TI's standard warranty. Testing and other quality control techniques are used to the extent TI deems necessary to support this warranty. Except where mandated by government requirements, testing of all parameters of each product is not necessarily performed.

TI assumes no liability for applications assistance or customer product design. Customers are responsible for their products and applications using TI components. To minimize the risks associated with customer products and applications, customers should provide adequate design and operating safeguards.

TI does not warrant or represent that any license, either express or implied, is granted under any TI patent right, copyright, mask work right, or other TI intellectual property right relating to any combination, machine, or process in which TI products or services are used. Information published by TI regarding third-party products or services does not constitute a license from TI to use such products or services or a warranty or endorsement thereof. Use of such information may require a license from a third party under the patents or other intellectual property of the third party, or a license from TI under the patents or other intellectual property of TI.

Reproduction of TI information in TI data books or data sheets is permissible only if reproduction is without alteration and is accompanied by all associated warranties, conditions, limitations, and notices. Reproduction of this information with alteration is an unfair and deceptive business practice. TI is not responsible or liable for such altered documentation. Information of third parties may be subject to additional restrictions.

Resale of TI products or services with statements different from or beyond the parameters stated by TI for that product or service voids all express and any implied warranties for the associated TI product or service and is an unfair and deceptive business practice. TI is not responsible or liable for any such statements.

TI products are not authorized for use in safety-critical applications (such as life support) where a failure of the TI product would reasonably be expected to cause severe personal injury or death, unless officers of the parties have executed an agreement specifically governing such use. Buyers represent that they have all necessary expertise in the safety and regulatory ramifications of their applications, and acknowledge and agree that they are solely responsible for all legal, regulatory and safety-related requirements concerning their products and any use of TI products in such safety-critical applications, notwithstanding any applications-related information or support that may be provided by TI. Further, Buyers must fully indemnify TI and its representatives against any damages arising out of the use of TI products in such safety-critical applications.

TI products are neither designed nor intended for use in military/aerospace applications or environments unless the TI products are specifically designated by TI as military-grade or "enhanced plastic." Only products designated by TI as military-grade meet military specifications. Buyers acknowledge and agree that any such use of TI products which TI has not designated as military-grade is solely at the Buyer's risk, and that they are solely responsible for compliance with all legal and regulatory requirements in connection with such use.

TI products are neither designed nor intended for use in automotive applications or environments unless the specific TI products are designated by TI as compliant with ISO/TS 16949 requirements. Buyers acknowledge and agree that, if they use any non-designated products in automotive applications, TI will not be responsible for any failure to meet such requirements.

Following are URLs where you can obtain information on other Texas Instruments products and application solutions:

Products		Applications	
Amplifiers	amplifier.ti.com	Audio	www.ti.com/audio
Data Converters	dataconverter.ti.com	Automotive	www.ti.com/automotive
DLP® Products	www.dlp.com	Communications and Telecom	www.ti.com/communications
DSP	dsp.ti.com	Computers and Peripherals	www.ti.com/computers
Clocks and Timers	www.ti.com/clocks	Consumer Electronics	www.ti.com/consumer-apps
Interface	interface.ti.com	Energy	www.ti.com/energy
Logic	logic.ti.com	Industrial	www.ti.com/industrial
Power Mgmt	power.ti.com	Medical	www.ti.com/medical
Microcontrollers	microcontroller.ti.com	Security	www.ti.com/security
RFID	www.ti-rfid.com	Space, Avionics & Defense	www.ti.com/space-avionics-defense
RF/IF and ZigBee® Solutions	www.ti.com/lprf	Video and Imaging	www.ti.com/video
		Wireless	www.ti.com/wireless-apps