

Single Operational Amplifier with Darlington Input

TCA 332
TCA 335

Features

- High input impedance
- Wide common-mode range
- Large supply-voltage range
- Large control range
- High output current
- Simple frequency compensation
- Wide temperature range (TCA 332)
- NPN Darlington input
- Open collector output

Bipolar IC

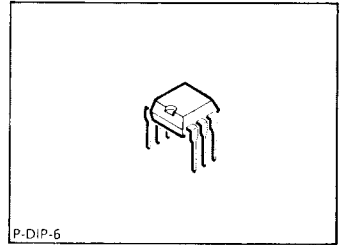

Applications

- Amplifier
- Comparator
- Level converter
- Impedance converter
- Driver

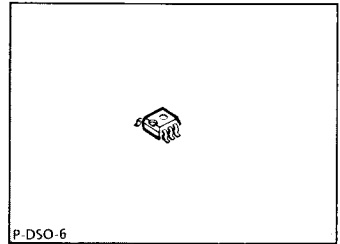

Type	Ordering Code	Package	Color Code
■ □ TCA 332 A	Q67000-A2272	P-DIP-6	—
■ TCA 332 G	Q67000-A2270	P-DSO 6 (SMD)	orange/yellow
■ □ TCA 335 A	Q67000-A563	P-DIP-6	—
■ □ TCA 335 G	Q67000-A1018-G403	P-DSO-6	blue/yellow

■ = Not for new design

For TCA 315 and TCA 325 see **chapter “Comparators”**.

These op amps are particularly economic and versatile. Owing to their excellent performance characteristics they are well suited for a wide scope of applications, such as measuring and control engineering, automotive electronics, AF circuits, analog computers, etc. The low input current of these amplifiers is particularly advantageous for application in measuring and control systems.

Circuit Diagram

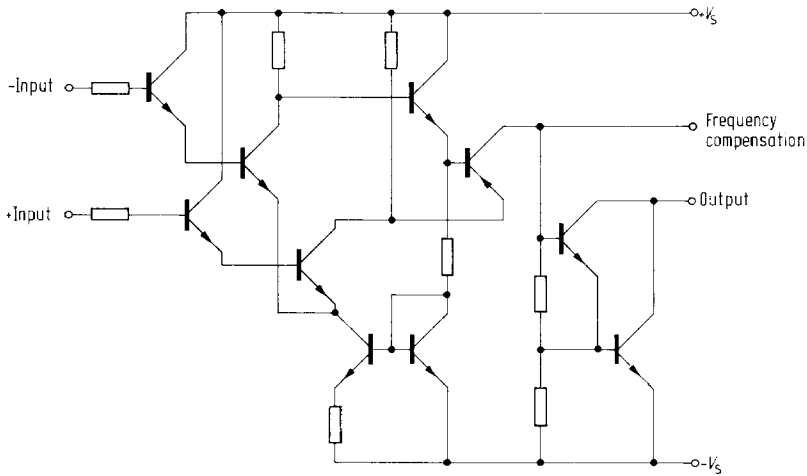

**Pin Configurations
(top view)**

**TCA 332 A
TCA 335 A**

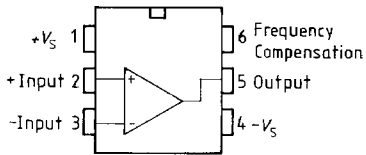

**TCA 332 G
TCA 335 G**

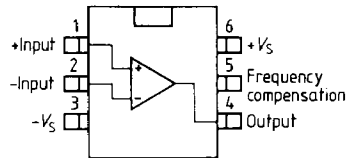

Connection Diagram

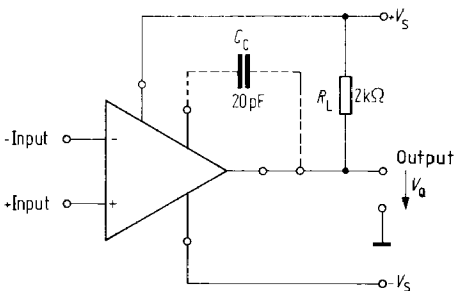

C_C = output frequency compensation
 R_L = load resistance (collector resistance)

Absolute Maximum Ratings

Parameter	Symbol	Limit Values	Unit
Supply voltage	V_S	± 15	V
Output current	I_Q	70	mA
Differential input voltage: $V_S = 13$ to 15 V	V_{ID}	± 13	V
Differential input voltage: $V_S = 2$ to 13 V	V_{ID}	$\pm V_S$	V
Junction temperature	T_j	150	$^{\circ}\text{C}$
Storage temperature range	T_{stg}	-55 to 125	$^{\circ}\text{C}$
Thermal resistance system – air	TCA 332 A TCA 332 G R_{thSA} R_{thSA}	115 200	K/W K/W

Operating Range

Supply voltage	V_S	± 2 to ± 15	V
Ambient temperature	T_A	-55 to 125	$^{\circ}\text{C}$

Characteristics

$V_S = \pm 5$ V to ± 15 V

$R_L = 2$ k Ω , unless otherwise specified

Parameter	Symbol	Limit Values $T_A = 25^{\circ}\text{C}$			Limit Values $T_A = -55$ to 125°C		Unit
		min.	typ.	max.	min.	max.	
Open-loop supply current consumption	I_S		1.5	2.5		2.5	mA
Input offset voltage $R_G = 50$ Ω	V_{IO}	-10		10	-15	15	mV
Input offset current	I_{JO}	-5		5	-10	10	nA
Input current	I_I		5	15		25	nA
Input current $V_{ID} = \pm 13$ V	I_I			200			nA
Control range							
$V_S = \pm 15$ V	V_{Qpp}	14.9		-14.0	14.8	-14.0	V
$R_L = 620$ Ω , $V_S = \pm 15$ V	V_{Qpp}	14.9		-12.5	14.8	-12.0	V
$V_S = \pm 15$ V, $f = 100$ kHz	V_{Qpp}		± 10				V

Characteristics
 $V_S = \pm 5 \text{ V}$ to $\pm 15 \text{ V}$; $R_L = 2 \text{ k}\Omega$, unless otherwise specified

Parameter	Symbol	Limit Values $T_A = 25^\circ\text{C}$			Limit Values $T_A = -55$ to 125°C		Unit
		min.	typ.	max.	min.	max.	
Input impedance $f = 1 \text{ kHz}$	Z_I		3				$\text{M}\Omega$
Open-loop voltage gain $f = 1 \text{ kHz}$ $R_L = 10 \text{ k}\Omega$, $f = 1 \text{ kHz}$ $f = 1 \text{ MHz}$	G_{V0} G_{V0} G_{V0}	80	83 88 43		75		dB dB dB
Common-mode input voltage range	V_{IC}	$-V_S+2$		V_S-2	$-V_S+3$	V_S-3	V
Common-mode rejection $R_L = 2 \text{ k}\Omega$	k_{CMR}	75	80		70		dB
Supply voltage rejection $G_V = 100$	k_{SVR}		25	200		200	$\mu\text{V/V}$
Temperature coefficient of V_{IO} $R_G = 50 \Omega$ Temperature coefficient of I_{IO} $R_G = 50 \Omega$	α_{VIO} α_{IIO}		12 50	50		50	$\mu\text{V/K}$ pA/K
Slew rate of V_O for non-inverting operation ¹⁾ (see TAA 765, test circuit 1)	SR		9				$\text{V}/\mu\text{s}$
Slew rate of V_O for inverting operation ¹⁾ (see TAA 765, test circuit 2)	SR		18				$\text{V}/\mu\text{s}$
Output saturation voltage $I_Q = 10 \text{ mA}$	V_{Qsat}			1			V
Output reverse current	I_{QR}			1		5	μA

Characteristics
 $V_S = \pm 2 \text{ V}$, $R_L = 2 \text{ k}\Omega$

Input offset voltage $R_G = 50 \Omega$	V_{IO}	-10		10	-15	15	mV
Input offset current Input current	I_{IO} I_I	-5	5	5 15	-10	10 25	nA nA
Open-loop voltage gain $f = 1 \text{ kHz}$	G_{V0}	75			70		dB

¹⁾ For the relationship between power bandwidth and slew rate refer to "Introduction to Operational Amplifiers"

Absolute Maximum Ratings

Parameter	Symbol	Limit Values	Unit
Supply voltage	V_S	± 15	V
Output current	I_Q	70	mA
Differential input voltage: $V_S = 13$ to 15 V	V_{ID}	± 13	V
Differential input voltage: $V_S = 2$ to 13 V	V_{ID}	$\pm V_S$	V
Junction temperature	T_j	150	$^{\circ}\text{C}$
Storage temperature range	T_{stg}	-55 to 125	$^{\circ}\text{C}$
Thermal resistance system – air	TCA 335 A TCA 335 G	$R_{th SA}$ $R_{th SA}$	K/W K/W
		115 200	

Operating Range

Supply voltage	V_S	± 2 to ± 15	V
Ambient temperature	T_A	-25 to 85	$^{\circ}\text{C}$

Characteristics

$V_S = \pm 5$ V to ± 15 V; $R_L = 2$ k Ω ,
unless otherwise specified

Parameter	Symbol	Limit Values $T_A = 25^{\circ}\text{C}$			Limit Values $T_A = -25$ to 85°C		Unit
		min.	typ.	max.	min.	max.	
Open-loop supply current consumption	I_S		1.5	2.5		2.5	mA
Input offset voltage $R_G = 50 \Omega$	V_{IO}	-15		15	-18	18	mV
Input offset current	I_{IO}	-10		10	-20	20	nA
Input current	I_I		5	25		35	nA
Input current $V_{ID} = \pm 13$ V	I_I			200			nA
Control range $V_S = \pm 15$ V	$V_{Q pp}$	14.9		-14.0	14.8	-14.0	V
$R_L = 620 \Omega$, $V_S = \pm 15$ V	$V_{Q pp}$	14.9		-12.5	14.8	-12.0	V
$V_S = \pm 15$ V, $f = 100$ kHz	$V_{Q pp}$		± 10				V

Characteristics

$V_S = \pm 5 \text{ V}$ to $\pm 15 \text{ V}$; $R_L = 2 \text{ k}\Omega$,
unless otherwise specified

Parameter	Symbol	Limit Values $T_A = 25^\circ\text{C}$			Limit Values $T_A = -25$ to 85°C		Unit
		min.	typ.	max.	min.	max.	
Input impedance $f = 1 \text{ kHz}$	Z_I		3				$\text{M}\Omega$
Open-loop voltage gain $f = 1 \text{ kHz}$ $R_L = 10 \text{ k}\Omega$, $f = 1 \text{ kHz}$ $f = 1 \text{ MHz}$	G_{V0} G_{V0} G_{V0}	75	80 85 43		75		dB dB dB
Common-mode input voltage range	V_{IC}	$-V_S+2$		V_S-2	$-V_S+3$	V_S-3	V
Common-mode rejection	k_{CMR}	70	78		70		dB
Supply voltage rejection $G_V = 100$	k_{SVR}		25	200		200	$\mu\text{V/V}$
Temperature coefficient of V_{IO} $R_G = 50 \Omega$	α_{VIO}		12	50		50	$\mu\text{V/K}$
Temperature coefficient of I_{IO} $R_G = 50 \Omega$	α_{II0}		50				pA/K
Slew rate of V_O for non-inverting operation ¹⁾ (see TAA 765, test circuit 1)	SR		9				$\text{V}/\mu\text{s}$
Slew rate of V_O for inverting operation ¹⁾ (see TAA 765, test circuit 2)	SR		18				$\text{V}/\mu\text{s}$
Output saturation voltage $I_Q = 10 \text{ mA}$	V_{Qsat}			1			V
Output reverse current	I_{QR}			10		20	μA

Characteristics

$V_S = \pm 2 \text{ V}$, $R_L = 2 \text{ k}\Omega$

Input offset voltage $R_G = 50 \Omega$	V_{IO}	-17		17	-20	20	mV
Input offset current Input current	I_{IO} I_I	-10	5	10 25	-20	20 35	nA nA
Open-loop voltage gain $f = 1 \text{ kHz}$	G_{V0}	70			70		dB

¹⁾ For the relationship between power bandwidth and slew rate refer to "Introduction to Operational Amplifiers"

Input current versus ambient temperature
 $R_L = 2 \text{ k}\Omega$

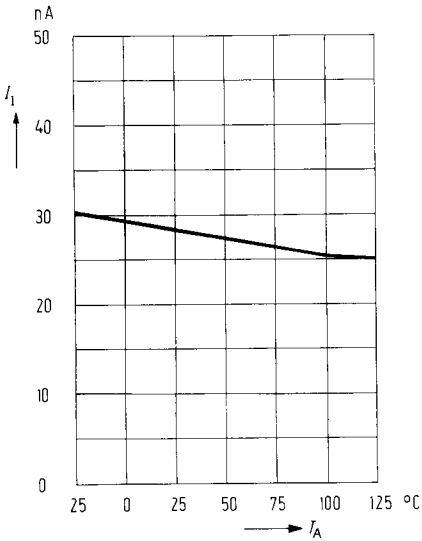

Input current versus supply voltage
 $T_A = 25^\circ\text{C}; R_L = 2 \text{ k}\Omega$

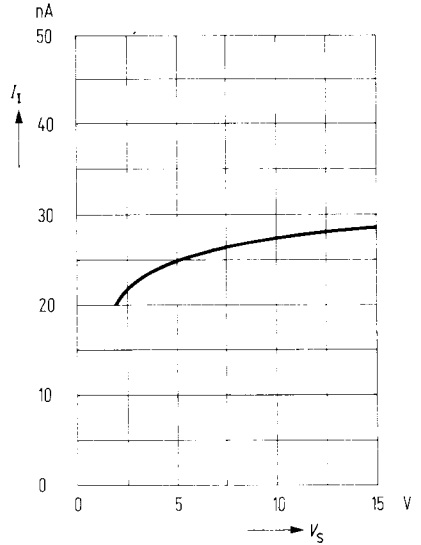

Input offset voltage versus supply voltage

