

# μA741, μA741Y GENERAL-PURPOSE OPERATIONAL AMPLIFIERS

SLOS094A – NOVEMBER 1970 – REVISED JANUARY 1992

- Short-Circuit Protection
- Offset-Voltage Null Capability
- Large Common-Mode and Differential Voltage Ranges
- No Frequency Compensation Required
- Low Power Consumption
- No Latch-Up
- Designed to Be Interchangeable With Fairchild μA741

## description

The μA741 is a general-purpose operational amplifier featuring offset-voltage null capability.

The high common-mode input voltage range and the absence of latch-up make the amplifier ideal for voltage-follower applications. The device is short-circuit protected and the internal frequency compensation ensures stability without external components. A low value potentiometer may be connected between the offset null inputs to null out the offset voltage as shown in Figure 2.

The μA741C is characterized for operation from 0°C to 70°C. The μA741I is characterized for operation from -40°C to 85°C. The μA741M is characterized for operation over the full military temperature range of -55°C to 125°C.

## symbol

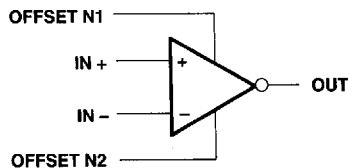

μA741M ... J PACKAGE  
(TOP VIEW)

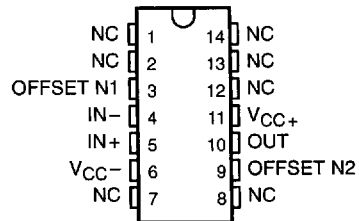

μA741M ... JG PACKAGE  
μA741C, μA741I ... D, P, OR PW PACKAGE  
(TOP VIEW)

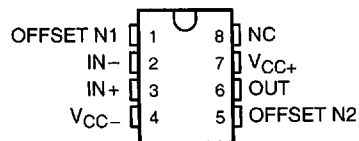

μA741M ... U PACKAGE  
(TOP VIEW)

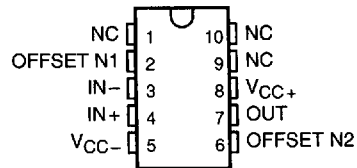

μA741M ... FK PACKAGE  
(TOP VIEW)

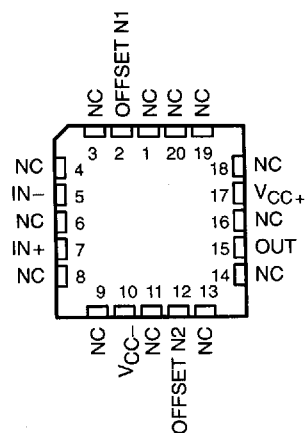

NC – No internal connection

■ 8961724 0108030 670 ■

PRODUCTION DATA information is current as of publication date. Products conform to specifications per the terms of Texas Instruments standard warranty. Production processing does not necessarily include testing of all parameters.

**TEXAS  
INSTRUMENTS**

POST OFFICE BOX 655303 • DALLAS, TEXAS 75265

Copyright © 1992, Texas Instruments Incorporated

# $\mu$ A741, $\mu$ A741Y GENERAL-PURPOSE OPERATIONAL AMPLIFIERS

SLOS094A – NOVEMBER 1970 – REVISED JANUARY 1992

## AVAILABLE OPTIONS

T <sub>A</sub>	PACKAGED DEVICES							CHIP FORM (Y)
	SMALL OUTLINE (D)	CHIP CARRIER (FK)	CERAMIC DIP (J)	CERAMIC DIP (JG)	PLASTIC DIP (P)	TSSOP (PW)	FLAT PACK (U)	
0°C to 70°C	$\mu$ A741CD				$\mu$ A741CP	$\mu$ A741CPW		$\mu$ A741Y
-40°C to 85°C	$\mu$ A741ID				$\mu$ A741IP			
-55°C to 125°C		$\mu$ A741MFK	$\mu$ A741MJ	$\mu$ A741MJG			$\mu$ A741MU	

The D package is available taped and reeled. Add the suffix R (e.g.,  $\mu$ A741CDR).

## schematic

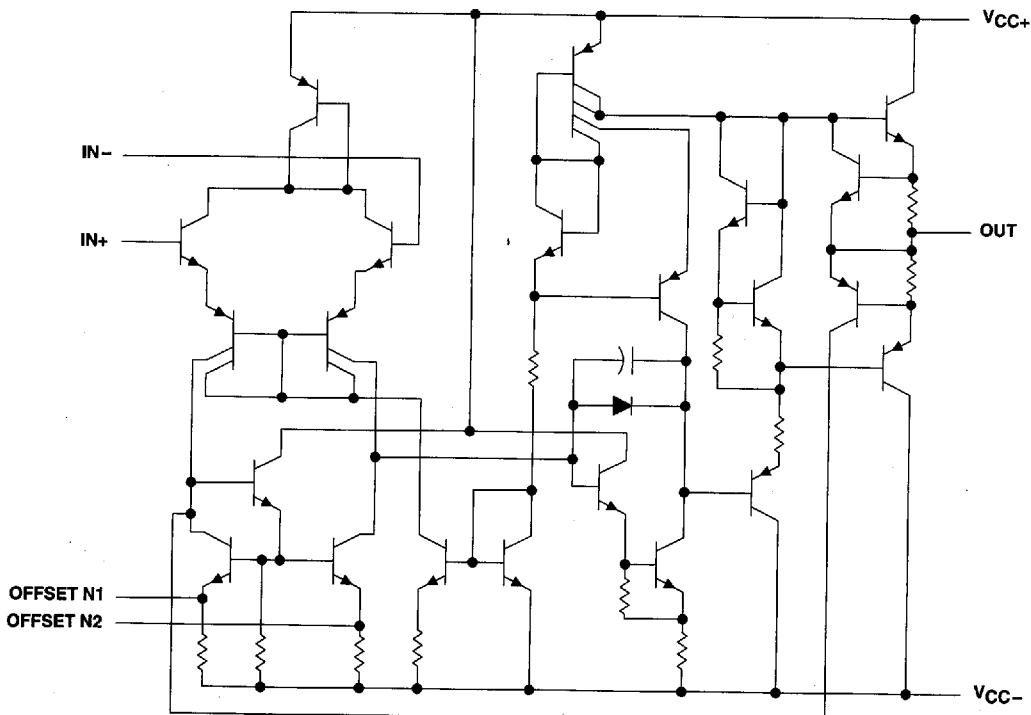

Component Count	
Transistors	22
Resistors	11
Diode	1
Capacitor	1

8961724 0108031 507

 **TEXAS  
INSTRUMENTS**

POST OFFICE BOX 655303 • DALLAS, TEXAS 75265

# $\mu$ A741, $\mu$ A741Y GENERAL-PURPOSE OPERATIONAL AMPLIFIERS

SLOS094A - NOVEMBER 1970 - REVISED JANUARY 1992

## $\mu$ A741Y chip information

This chip, when properly assembled, displays characteristics similar to the  $\mu$ A741C. Thermal compression or ultrasonic bonding may be used on the doped-aluminum bonding pads. Chips may be mounted with conductive epoxy or a gold-silicon preform.

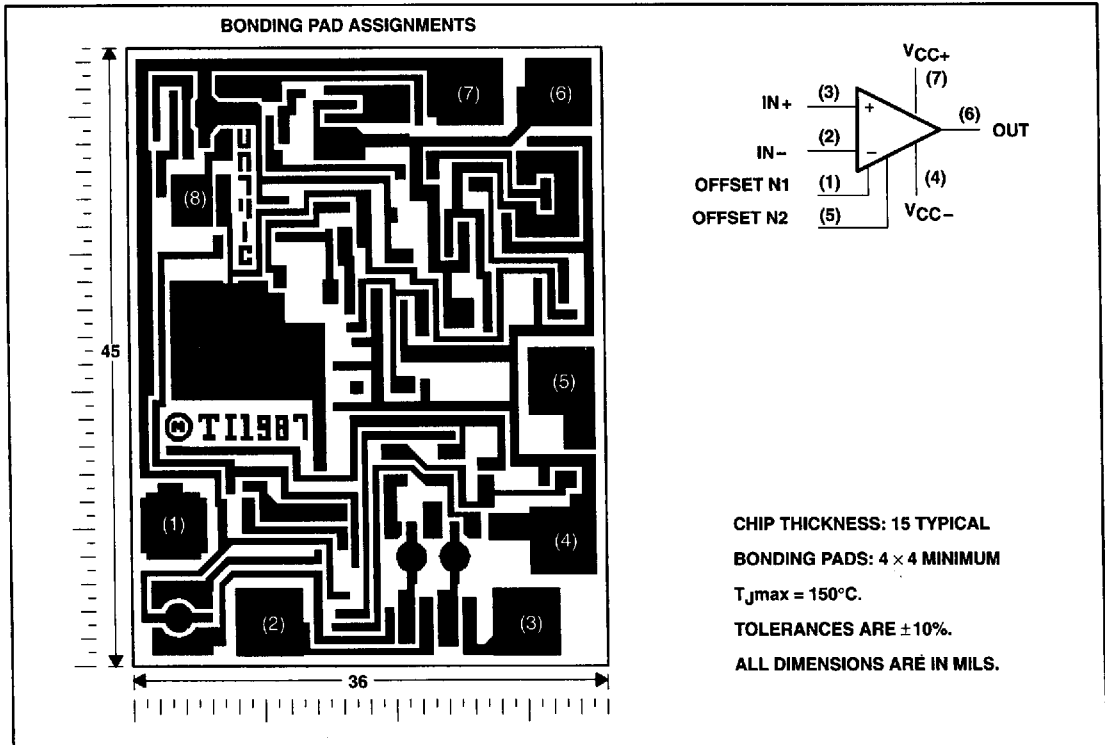

8961724 0108032 443

 **TEXAS  
INSTRUMENTS**

POST OFFICE BOX 655303 • DALLAS, TEXAS 75265

6-911

# $\mu$ A741, $\mu$ A741Y GENERAL-PURPOSE OPERATIONAL AMPLIFIERS

SLOS094A – NOVEMBER 1970 – REVISED JANUARY 1992

## absolute maximum ratings over operating free-air temperature range (unless otherwise noted)<sup>†</sup>

	$\mu$ A741C	$\mu$ A741I	$\mu$ A741M	UNIT
Supply voltage, $V_{CC+}$ (see Note 1)	18	22	22	V
Supply voltage, $V_{CC-}$ (see Note 1)	-18	-22	-22	V
Differential input voltage, $V_{ID}$ (see Note 2)	$\pm 15$	$\pm 30$	$\pm 30$	V
Input voltage, $V_I$ any input (see Notes 1 and 3)	$\pm 15$	$\pm 15$	$\pm 15$	V
Voltage between offset null (either OFFSET N1 or OFFSET N2) and $V_{CC-}$	$\pm 15$	$\pm 0.5$	$\pm 0.5$	V
Duration of output short circuit (see Note 4)	unlimited	unlimited	unlimited	
Continuous total power dissipation	See Dissipation Rating Table			
Operating free-air temperature range, $T_A$	0 to 70	-40 to 85	-55 to 125	$^{\circ}$ C
Storage temperature range	-65 to 150	-65 to 150	-65 to 150	$^{\circ}$ C
Case temperature for 60 seconds	FK package		260	$^{\circ}$ C
Lead temperature 1,6 mm (1/16 inch) from case for 60 seconds	J, JG, or U package		300	$^{\circ}$ C
Lead temperature 1,6 mm (1/16 inch) from case for 10 seconds	D, P, or PW package		260	$^{\circ}$ C

<sup>†</sup> Stresses beyond those listed under "absolute maximum ratings" may cause permanent damage to the device. These are stress ratings only, and functional operation of the device at these or any other conditions beyond those indicated under "recommended operating conditions" is not implied. Exposure to absolute-maximum-rated conditions for extended periods may affect device reliability.

- NOTES:
1. All voltage values, unless otherwise noted, are with respect to the midpoint between  $V_{CC+}$  and  $V_{CC-}$ .
  2. Differential voltages are at  $IN+$  with respect to  $IN-$ .
  3. The magnitude of the input voltage must never exceed the magnitude of the supply voltage or 15 V, whichever is less.
  4. The output may be shorted to ground or either power supply. For the  $\mu$ A741M only, the unlimited duration of the short circuit applies at (or below) 125 $^{\circ}$ C case temperature or 75 $^{\circ}$ C free-air temperature.

DISSIPATION RATING TABLE

PACKAGE	$T_A \leq 25^{\circ}$ C POWER RATING	DERATING FACTOR	DERATE ABOVE $T_A$	$T_A = 70^{\circ}$ C POWER RATING	$T_A = 85^{\circ}$ C POWER RATING	$T_A = 125^{\circ}$ C POWER RATING
D	500 mW	5.8 mW/ $^{\circ}$ C	64 $^{\circ}$ C	464 mW	377 mW	N/A
FK	500 mW	11.0 mW/ $^{\circ}$ C	105 $^{\circ}$ C	500 mW	500 mW	275 mW
J	500 mW	11.0 mW/ $^{\circ}$ C	105 $^{\circ}$ C	500 mW	500 mW	275 mW
JG	500 mW	8.4 mW/ $^{\circ}$ C	90 $^{\circ}$ C	500 mW	500 mW	210 mW
P	500 mW	N/A	N/A	500 mW	500 mW	N/A
PW	525 mW	4.2 mW/ $^{\circ}$ C	25 $^{\circ}$ C	336 mW	N/A	N/A
U	500 mW	5.4 mW/ $^{\circ}$ C	57 $^{\circ}$ C	432 mW	351 mW	135 mW

8961724 0108033 3&T

 **TEXAS  
INSTRUMENTS**

# μA741, μA741Y GENERAL-PURPOSE OPERATIONAL AMPLIFIERS

SLOS094A – NOVEMBER 1970 – REVISED JANUARY 1992

**electrical characteristics at specified free-air temperature,  $V_{CC\pm} = \pm 15\text{ V}$  (unless otherwise noted)**

PARAMETER	TEST CONDITIONS	$T_A$ †	μA741C			μA741I, μA741M			UNIT
			MIN	TYP	MAX	MIN	TYP	MAX	
$V_{IO}$ Input offset voltage	$V_O = 0$	25°C		1	6		1	5	mV
		Full range			7.5			6	
$\Delta V_{IO(adj)}$ Offset voltage adjust range	$V_O = 0$	25°C		±15			±15		mV
$I_{IO}$ Input offset current	$V_O = 0$	25°C		20	200		20	200	nA
		Full range			300			500	
$I_{IB}$ Input bias current	$V_O = 0$	25°C		80	500		80	500	nA
		Full range			800			1500	
$V_{ICR}$ Common-mode input voltage range		25°C	±12	±13		±12	±13		V
		Full range	±12			±12			
$V_{OM}$ Maximum peak output voltage swing	$R_L = 10\text{ k}\Omega$	25°C	±12	±14		±12	±14		V
	$R_L \geq 10\text{ k}\Omega$	Full range	±12			±12			
	$R_L = 2\text{ k}\Omega$	25°C	±10	±13		±10	±13		
	$R_L \geq 2\text{ k}\Omega$	Full range	±10			±10			
$A_{VD}$ Large-signal differential voltage amplification	$R_L \geq 2\text{ k}\Omega$	25°C	20	200		50	200		V/mV
	$V_O = \pm 10\text{ V}$	Full range	15			25			
$r_i$ Input resistance		25°C	0.3	2		0.3	2		MΩ
$r_o$ Output resistance	$V_O = 0$ , See Note 5	25°C		75			75		Ω
$C_i$ Input capacitance		25°C		1.4			1.4		pF
CMRR Common-mode rejection ratio	$V_{IC} = V_{ICRmin}$	25°C	70	90		70	90		dB
		Full range	70			70			
$k_{SVS}$ Supply voltage sensitivity ( $\Delta V_{IO}/\Delta V_{CC}$ )	$V_{CC} = \pm 9\text{ V to } \pm 15\text{ V}$	25°C		30	150		30	150	μV/V
		Full range			150			150	
$I_{OS}$ Short-circuit output current		25°C		±25	±40		±25	±40	mA
$I_{CC}$ Supply current	$V_O = 0$ , No load	25°C		1.7	2.8		1.7	2.8	mA
		Full range			3.3			3.3	
$P_D$ Total power dissipation	$V_O = 0$ , No load	25°C		50	85		50	85	mW
		Full range			100			100	

† All characteristics are measured under open-loop conditions with zero common-mode input voltage unless otherwise specified. Full range for the μA741C is 0°C to 70°C, the μA741I is -40°C to 85°C, and the μA741M is -55°C to 125°C.

NOTE 5: This typical value applies only at frequencies above a few hundred hertz because of the effects of drift and thermal feedback.

## operating characteristics, $V_{CC\pm} = \pm 15\text{ V}$ , $T_A = 25^\circ\text{C}$

PARAMETER	TEST CONDITIONS	μA741C			μA741I, μA741M			UNIT
		MIN	TYP	MAX	MIN	TYP	MAX	
$t_r$ Rise time	$V_I = 20\text{ mV}$ , $R_L = 2\text{ k}\Omega$		0.3			0.3		μs
Overshoot factor	$C_L = 100\text{ pF}$ , See Figure 1		5%			5%		
SR Slew rate at unity gain	$V_I = 10\text{ V}$ , $R_L = 2\text{ k}\Omega$ , $C_L = 100\text{ pF}$ , See Figure 1		0.5			0.5		V/μs

8961724 0108034 216

 **TEXAS  
INSTRUMENTS**

POST OFFICE BOX 655303 • DALLAS, TEXAS 75265

6-913

# $\mu$ A741, $\mu$ A741Y GENERAL-PURPOSE OPERATIONAL AMPLIFIERS

SLOS094A – NOVEMBER 1970 – REVISED JANUARY 1992

electrical characteristics at specified free-air temperature,  $V_{CC\pm} = \pm 15$  V,  $T_A = 25^\circ\text{C}$  (unless otherwise noted)

PARAMETER	TEST CONDITIONS	$\mu$ A741Y			UNIT
		MIN	TYP	MAX	
$V_{IO}$ Input offset voltage	$V_O = 0$		1	6	mV
$\Delta V_{IO(\text{adj})}$ Offset voltage adjust range	$V_O = 0$		$\pm 15$		mV
$I_{IO}$ Input offset current	$V_O = 0$		20	200	nA
$I_{IB}$ Input bias current	$V_O = 0$		80	500	nA
$V_{ICR}$ Common-mode input voltage range		$\pm 12$	$\pm 13$		V
$V_{OM}$ Maximum peak output voltage swing	$R_L = 10$ k $\Omega$	$\pm 12$	$\pm 14$		V
	$R_L = 2$ k $\Omega$	$\pm 10$	$\pm 13$		
$A_{VD}$ Large-signal differential voltage amplification	$R_L \geq 2$ k $\Omega$	20	200		V/mV
$r_i$ Input resistance		0.3	2		M $\Omega$
$r_o$ Output resistance	$V_O = 0$ , See Note 5		75		$\Omega$
$C_i$ Input capacitance			1.4		pF
CMRR Common-mode rejection ratio	$V_{IC} = V_{ICR\text{min}}$	70	90		dB
k <sub>SVS</sub> Supply voltage sensitivity ( $\Delta V_{IO}/\Delta V_{CC}$ )	$V_{CC} = \pm 9$ V to $\pm 15$ V		30	150	$\mu\text{V/V}$
$I_{OS}$ Short-circuit output current			$\pm 25$	$\pm 40$	mA
$I_{CC}$ Supply current	$V_O = 0$ , No load		1.7	2.8	mA
$P_D$ Total power dissipation	$V_O = 0$ , No load		50	85	mW

† All characteristics are measured under open-loop conditions with zero common-mode voltage unless otherwise specified.

NOTE 5: This typical value applies only at frequencies above a few hundred hertz because of the effects of drift and thermal feedback.

operating characteristics,  $V_{CC\pm} = \pm 15$  V,  $T_A = 25^\circ\text{C}$

PARAMETER	TEST CONDITIONS	$\mu$ A741Y			UNIT
		MIN	TYP	MAX	
$t_r$ Rise time	$V_I = 20$ mV, $R_L = 2$ k $\Omega$ , $C_L = 100$ pF, See Figure 1		0.3		$\mu\text{s}$
Overshoot factor			5%		
SR Slew rate at unity gain	$V_I = 10$ V, $R_L = 2$ k $\Omega$ , $C_L = 100$ pF, See Figure 1		0.5		V/ $\mu\text{s}$

8961724 0108035 152

 **TEXAS  
INSTRUMENTS**

POST OFFICE BOX 655303 • DALLAS, TEXAS 75265

PARAMETER MEASUREMENT INFORMATION

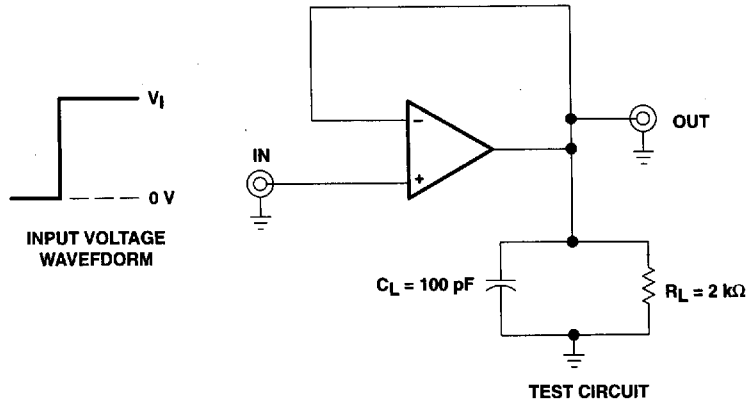

Figure 1. Rise Time, Overshoot, and Slew Rate

APPLICATION INFORMATION

Figure 2 shows a diagram for an input offset voltage null circuit.

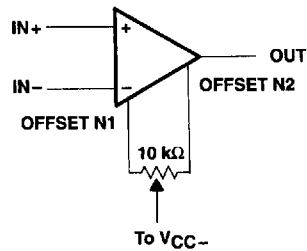

Figure 2. Input Offset Voltage Null Circuit

8961724 0108036 099

**μA741, μA741Y**  
**GENERAL-PURPOSE OPERATIONAL AMPLIFIERS**

SLOS094A – NOVEMBER 1970 – REVISED JANUARY 1992

**TYPICAL CHARACTERISTICS†**

**INPUT OFFSET CURRENT**  
**vs**  
**FREE-AIR TEMPERATURE**

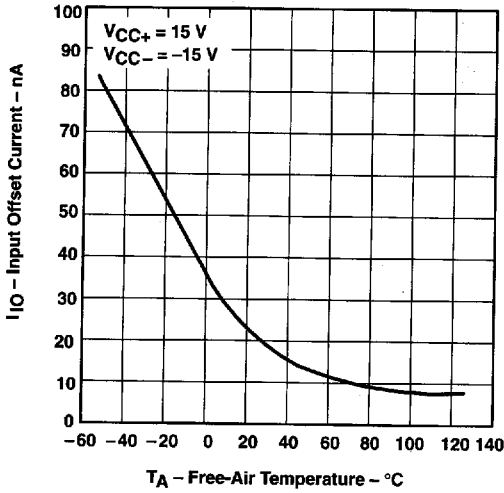

**Figure 3**

**INPUT BIAS CURRENT**  
**vs**  
**FREE-AIR TEMPERATURE**

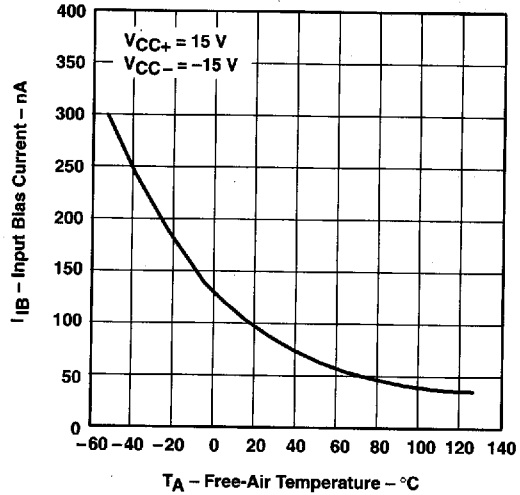

**Figure 4**

**MAXIMUM PEAK OUTPUT VOLTAGE**  
**vs**  
**LOAD RESISTANCE**

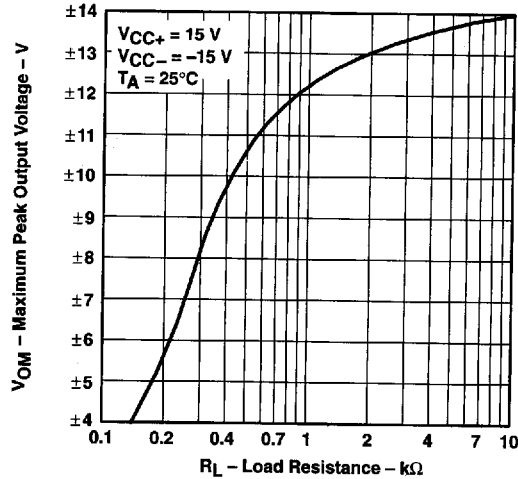

**Figure 5**

† Data at high and low temperatures are applicable only within the rated operating free-air temperature ranges of the various devices.



8961724 0108037 T25



$\mu$ A741,  $\mu$ A741Y  
GENERAL-PURPOSE OPERATIONAL AMPLIFIERS

SLOS094A – NOVEMBER 1970 – REVISED JANUARY 1992

**TYPICAL CHARACTERISTICS**

**MAXIMUM PEAK OUTPUT VOLTAGE  
vs  
FREQUENCY**

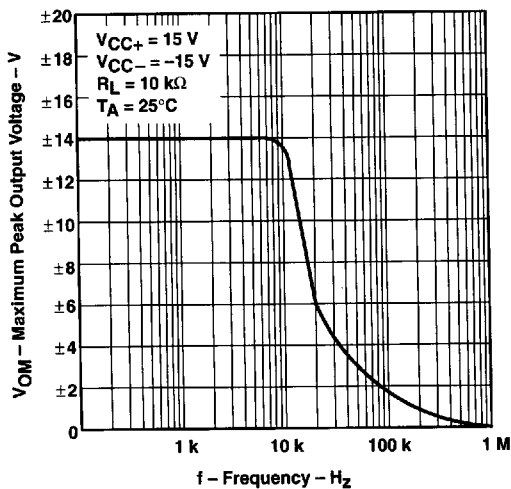

**OPEN-LOOP SIGNAL DIFFERENTIAL  
VOLTAGE AMPLIFICATION  
vs  
SUPPLY VOLTAGE**

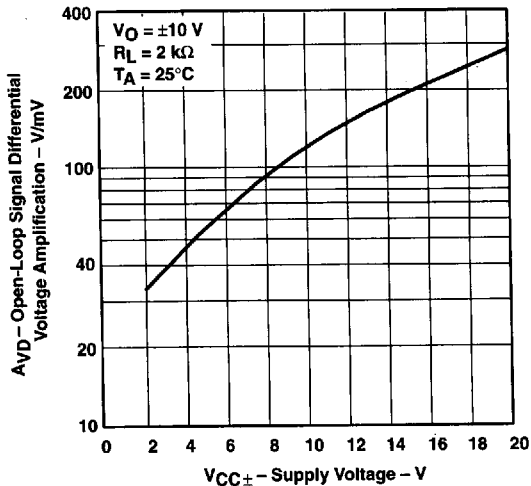

**OPEN-LOOP LARGE-SIGNAL DIFFERENTIAL  
VOLTAGE AMPLIFICATION  
vs  
FREQUENCY**

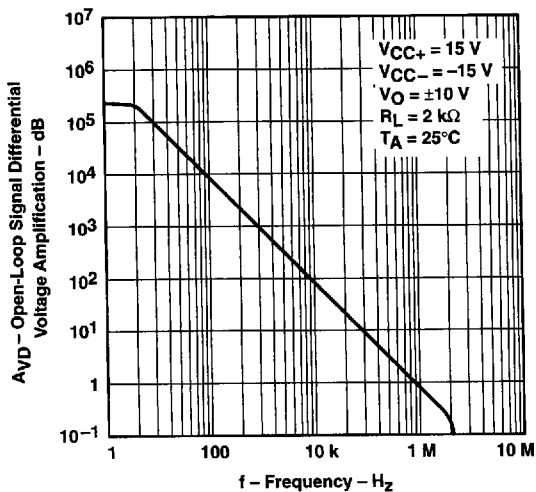

8961724 0108038 961

 **TEXAS  
INSTRUMENTS**

POST OFFICE BOX 655303 • DALLAS, TEXAS 75265

**$\mu$ A741,  $\mu$ A741Y**  
**GENERAL-PURPOSE OPERATIONAL AMPLIFIERS**

SLOS094A – NOVEMBER 1970 – REVISED JANUARY 1992

**TYPICAL CHARACTERISTICS**

**COMMON-MODE REJECTION RATIO  
 vs  
 FREQUENCY**

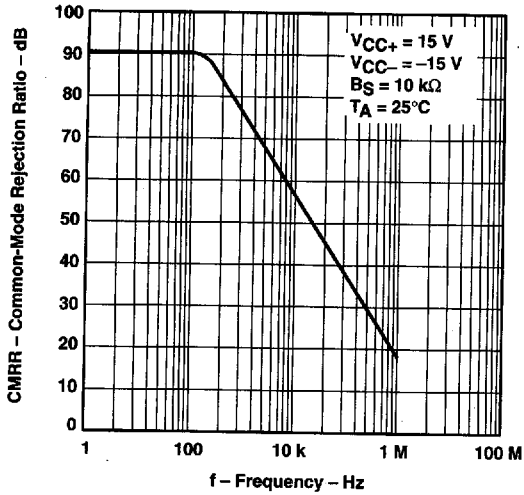

**Figure 9**

**OUTPUT VOLTAGE  
 vs  
 ELAPSED TIME**

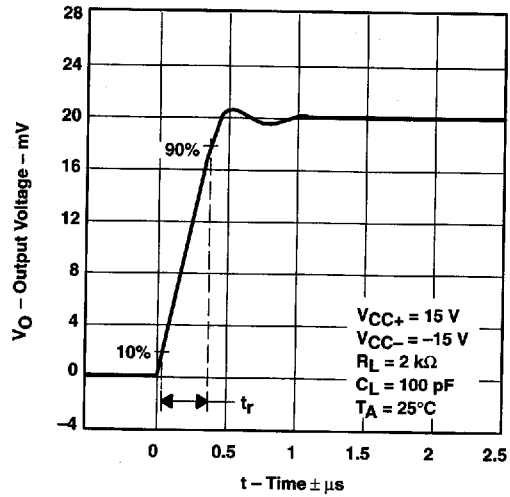

**Figure 10**

**VOLTAGE-FOLLOWER  
 LARGE-SIGNAL PULSE RESPONSE**

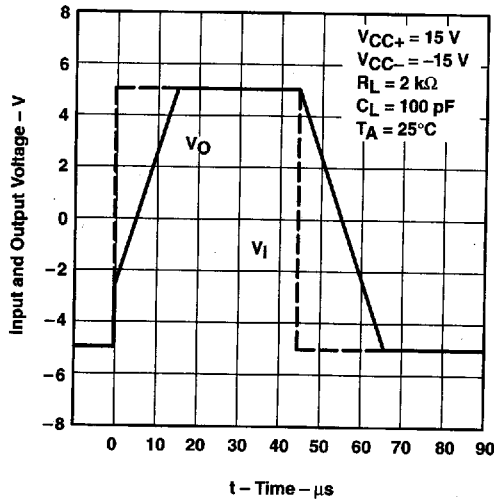

**Figure 11**

8961724 0108039 8T8



POST OFFICE BOX 655303 • DALLAS, TEXAS 75265