

# LINEAR INTEGRATED CIRCUITS



## HIGH-VOLTAGE, HIGH-CURRENT 7 DARLINGTON ARRAYS

These high-voltage, high-current Darlington transistor arrays comprise seven NPN Darlington pairs on a common monolithic substrate. All units feature open collector outputs and integral suppression diodes for inductive loads. Peak currents of 600 mA can be withstood, making them ideal for driving tungsten filament lamps.

The L 201 is a general-purpose array which may be used with DTL, TTL, PMOS, CMOS, etc. It is pinned with inputs opposite outputs to facilitate circuit board layout and is priced to compete directly with discrete transistor alternatives.

The L 202 was specifically designed for use with 14 to 25V PMOS devices.

Each input has a Zener diode and resistor in series in order to limit the input current to a safe value.

The L203 has a series base resistor to each Darlington pair allowing operation directly with TTL or CMOS operating at a supply voltage of 5V.

The L204 has a series base resistor to each Darlington pair, allowing operation directly with PMOS or CMOS utilizing supply voltage of 6 to 15V.

In all cases, the individual Darlington pair collector current rating is 500 mA. However, outputs may be paralleled for higher load current capability. The devices are supplied in a 16-lead dual in-line plastic package with copper frame.

## ABSOLUTE MAXIMUM RATINGS

$V_i$	Input voltage (for L 202, L 203 and L 204)	30	V
$V_o$	Output voltage (collector-emitter)	50	V
$V_{CEO(sus)}$	Collector-emitter sustaining voltage	36	V
$I_C$	Collector current	500	mA
$I_B$	Base current (for L 201 only)	25	mA
$P_{tot}$	Total power dissipation at $T_{amb} = 25^\circ\text{C}$	1.8	W
$T_{op}$	Operating junction temperature	-25 to 150	$^\circ\text{C}$
$T_{stg}$	Storage temperature	-55 to 150	$^\circ\text{C}$

ORDERING NUMBERS: L201B, L203B  
L202B, L204B

## MECHANICAL DATA

Dimensions in mm

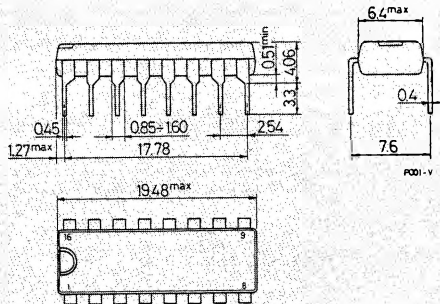



L201 L202  
L203 L204

## CONNECTION DIAGRAM (top view)

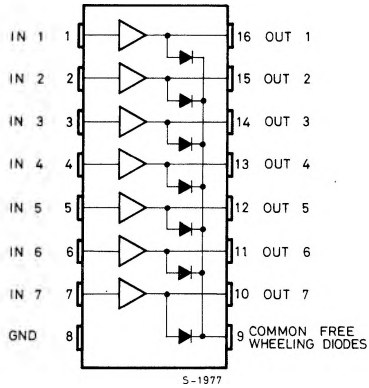

## SCHEMATIC DIAGRAM

For L 201

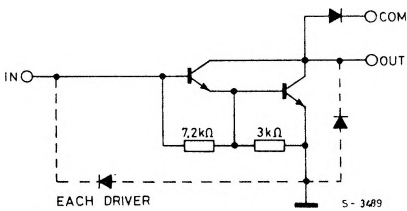

For L 202

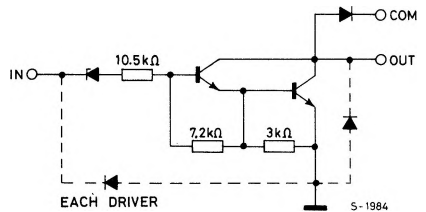

For L 203

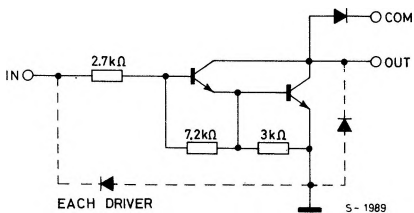

For L 204

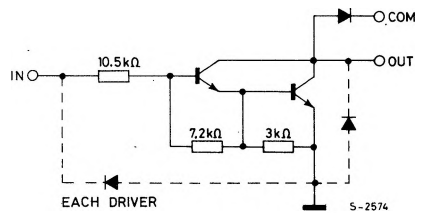



## THERMAL DATA

$R_{th\ j-amb}$	Thermal resistance junction-ambient	max.	70 °C/W
-----------------	-------------------------------------	------	---------

## ELECTRICAL CHARACTERISTICS ( $T_{amb} = 25^{\circ}C$ , unless otherwise specified)

Parameter	Test conditions	Min.	Typ.	Max.	Unit	Fig. No.
$I_{CEX}$	Collector cutoff current					
	for L 201 $V_{CE} = 50V$		0.2	3	$\mu A$	1
	for L 202 $V_{CE} = 50V$ $V_i = 7V$		0.2	3	$\mu A$	2
	for L 203, L 204 $V_{CE} = 50V$ $I_i = 0$		0.2	3	$\mu A$	1
$V_{CE(sat)}$	Collector-emitter saturation voltage					
	$I_C = 350\ mA$ $I_B = 500\ \mu A$		1.25	1.6	V	3
	$I_C = 200\ mA$ $I_B = 350\ \mu A$		1	1.3	V	
$I_C = 100\ mA$ $I_B = 250\ \mu A$		0.85	1.1	V		
$I_i$	Input current					
	for L 202 $V_i = 17V$		0.75	1.3	mA	5
	for L 203 $V_i = 3.85V$		0.9	1.35	mA	
	for L 204 $V_i = 5V$		0.35	0.5	mA	
$V_i = 12V$		1.1	1.45	mA		
$I_{C(off)}$	$V_{CE} = 50V$ $I_i = 25\ \mu A$			25	$\mu A$	4
$V_i$	Input voltage					
	for L 202 $I_C = 300\ mA$ $V_{CE} = 2V$		10.5	13	V	7
	for L 203 $I_C = 300\ mA$ $V_{CE} = 2V$		1.8	3	V	
	$I_C = 250\ mA$ $V_{CE} = 2V$		1.7	2.4	V	
	for L 204 $V_{CE} = 2V$ $I_C = 200\ mA$		4.5	6	V	
$V_{CE} = 2V$ $I_C = 350\ mA$		5	8	V		
$h_{FE}$	DC current gain (for L 201 only) $I_C = 350\ mA$ $V_{CE} = 2V$	1000	3000		—	3
$I_R$	Parallel diode reverse current $V_R = 50V$		0.5	50	$\mu A$	6
$V_F$	Parallel diode forward voltage $I_F = 350\ mA$		1.4	2	V	8
$t_{PLH}$	Turn-on delay time $0.5\ V_i$ to $0.5\ V_o$			5	$\mu s$	—
$t_{PHL}$	Turn-off delay time $0.5\ V_i$ to $0.5\ V_o$			5	$\mu s$	—

## TEST CIRCUITS

Fig 1 - For L 201, L 203 and L 204

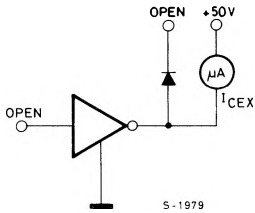

Fig. 2 - For L 202

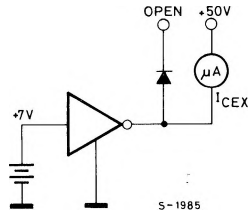

Fig. 3 - For L 201, L 202, L 203 and L 204

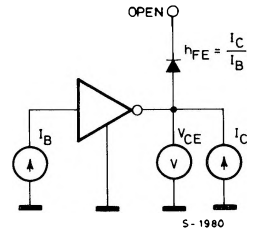

Fig. 4 - For L 201, L 202, L 203 and L 204

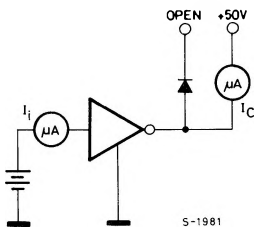

Fig. 5 - For L 202, L 203, and L 204

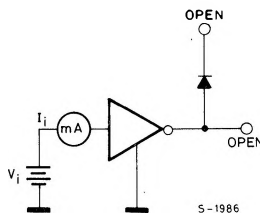

Fig. 6 - For L 201, L 202, L 203 and L 204

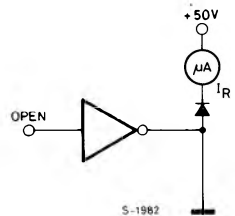

Fig. 7 - For L 202, L 203, and L 204

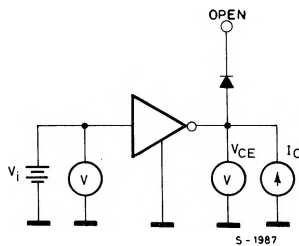
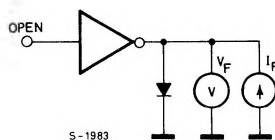
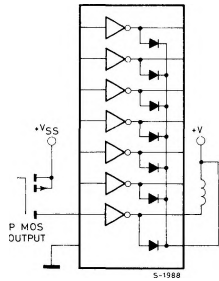

Fig. 8 - For L 201, L 202, L 203 and L 204



**APPLICATION CIRCUITS**

**PMOS to load (L 202 and L 204)**



**Fig. 9 - DC current gain, vs. collector current (for L 201)**

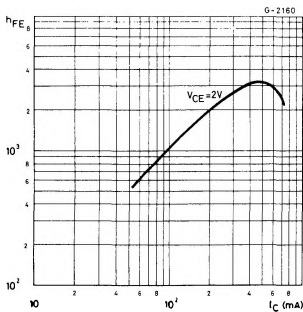

**Fig. 12 - Input current vs. input voltage (for L 202 and L 204)**

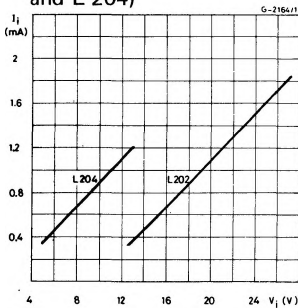

**Buffer for high current load (L 203 and L 204)**

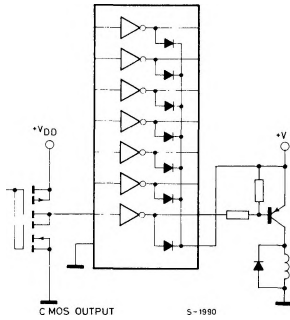

**Fig. 10 - Collector current vs. collector emitter saturation voltage**

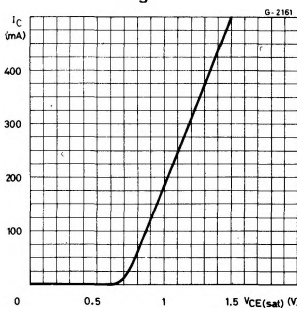

**Fig. 13 - Input current vs. input voltage (L 203)**

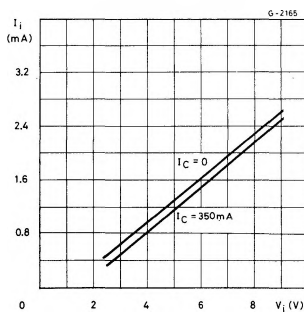

**TTL to load (L 203)**

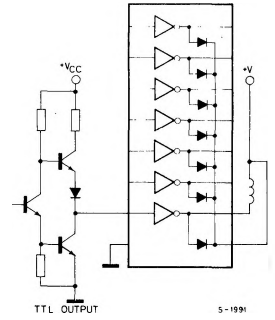

**Fig. 11 - Peak collector current as a function of duty cycle and number of outputs**

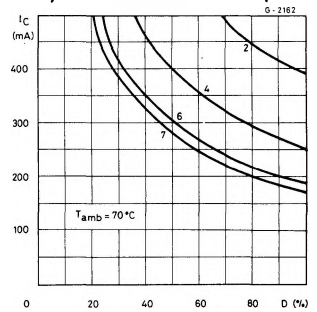

**Fig. 14 - Power rating chart**

