

# VCR7N Voltage Controlled Resistor JFET

## Features

- InterFET [N0001H Geometry](#)
- Low Leakage: 0.25 pA Typical
- Low Input Capacitance: 2.0 pF Typical
- High Input Impedance
- RoHS Compliant
- SMT, TH, and Bare Die Package options.

## Applications

- Voltage Controlled Resistor

## Description

The -15V InterFET VCR7N Voltage Controlled Resistor JFET are targeted for ultra high input impedance applications. Gate leakages are less than 1pA at room temperatures. The resistance range of the VCR7N is 4,000 Ohms to 8,000 Ohms. The TO-72 package is hermetically sealed and suitable for military applications.

TO-72 Bottom View

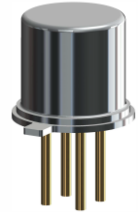
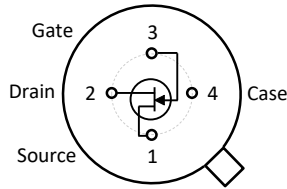

SOT23 Top View

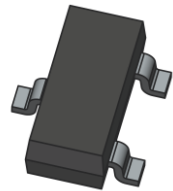
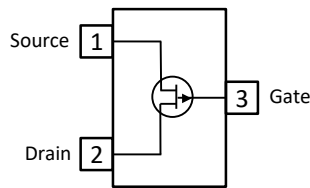

TO-92 Bottom View

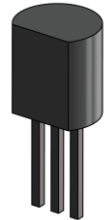
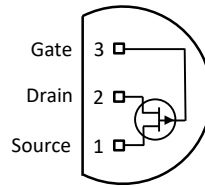

## Product Summary

Parameters		VCR7N Min	Unit
$BV_{GSS}$	Gate to Source Breakdown Voltage	-15	V
$V_{GS(off)}$	Gate to Source Cutoff Voltage	-2.5	V
$r_{ds(on)}$	Drain to Source ON Resistance	4,000	$\Omega$

## Ordering Information Custom Part and Binning Options Available

Part Number	Description	Case	Packaging
VCR7N	Through-Hole	TO-72	Bulk
PNVCR7N	Through-Hole	TO-92	Bulk
SMPVCR7N	Surface Mount	SOT23	Bulk
SMPVCR7NTR	7" Tape and Reel: Max 3,000 Pieces 13" Tape and Reel: Max 9,000 Pieces	SOT23	Minimum 1,000 Pieces Tape and Reel
VCR7NCOT	Chip Orientated Tray (COT Waffle Pack)	COT	400/Waffle Pack
VCR7NCFT	Chip Face-up Tray (CFT Waffle Pack)	CFT	400/Waffle Pack



**Disclaimer:** It is the Buyers responsibility for designing, validating and testing the end application under all field use cases and extreme use conditions. Guaranteeing the application meets required standards, regulatory compliance, and all safety and security requirements is the responsibility of the Buyer. These resources are subject to change without notice.

## Electrical Characteristics

### Maximum Ratings (@ $T_A = 25^\circ\text{C}$ , Unless otherwise specified)

Parameters	Value	Unit
$V_{RGS}$ Reverse Gate Source and Gate Drain Voltage	-15	V
$I_{FG}$ Continuous Forward Gate Current	10	mA
$P_D$ Continuous Device Power Dissipation	300	mW
P Power Derating	2.4	mW/ $^\circ\text{C}$
$T_J$ Operating Junction Temperature	-55 to 125	$^\circ\text{C}$
$T_{STG}$ Storage Temperature	-65 to 150	$^\circ\text{C}$

### Static Characteristics (@ $T_A = 25^\circ\text{C}$ , Unless otherwise specified)

Parameters	Conditions	VCR7N		Unit
		Min	Max	
$V_{(BR)GSS}$ Gate to Source Breakdown Voltage	$I_G = -1\mu\text{A}, V_{DS} = 0\text{V}$	-15		V
$I_{GSS}$ Gate to Source Reverse Current	$V_{GS} = -15\text{V}, V_{DS} = 0\text{V}$		-0.1	nA
$V_{GS(OFF)}$ Gate to Source Cutoff Voltage	$V_{DS} = 10\text{V}, I_D = -1\mu\text{A}$	-2.5	-5	V

### Dynamic Characteristics (@ $T_A = 25^\circ\text{C}$ , Unless otherwise specified)

Parameters	Conditions	VCR7N		Unit
		Min	Max	
$r_{ds(on)}$ Drain to Source ON Resistance	$I_D = 0\text{A}, V_{GS} = 0\text{V}, f = 1\text{kHz}$	4000	8000	$\Omega$
$C_{dg}$ Drain Gate Capacitance	$V_{DG} = 10\text{V}, I_S = 0\text{A}, f = 1\text{MHz}$		1.5	pF
$C_{sg}$ Source Gate Capacitance	$V_{DG} = 10\text{V}, I_D = 0\text{A}, f = 1\text{MHz}$		1.5	pF

## SOT23 (TO-236AB) Mechanical and Layout Data

### Package Outline Data



1. All linear dimensions are in millimeters.
2. Package weight approximately 0.12 grams
3. Molded plastic case UL 94V-0 rated
4. For Tape and Reel specifications refer to InterFET CTC-021 Tape and Reel Specification, Document number: IF39002
5. Bulk product is shipped in standard ESD shipping material
6. Refer to JEDEC standards for additional information.

### Suggested Pad Layout



1. All linear dimensions are in millimeters.
2. The suggested land pattern dimensions have been provided for reference only. A more robust pattern may be desired for wave soldering.



## TO-92 Mechanical and Layout Data

### Package Outline Data

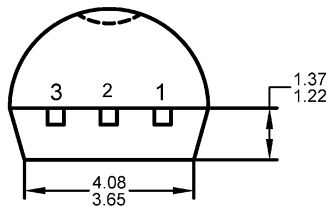
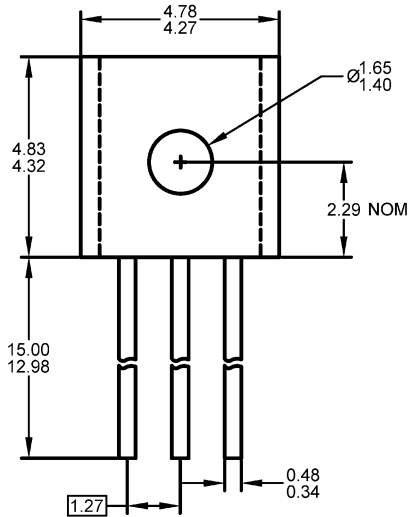

1. All linear dimensions are in millimeters.
2. Package weight approximately 0.19 grams
3. Molded plastic case UL 94V-0 rated
4. Bulk product is shipped in standard ESD shipping material
5. Refer to JEDEC standards for additional information.

### Suggested Through-Hole Layout

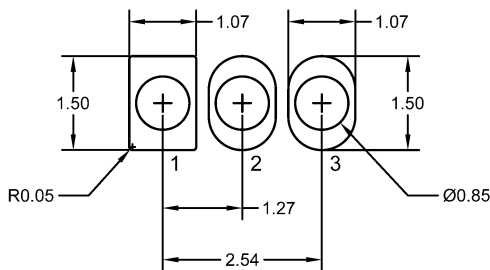

1. All linear dimensions are in millimeters.
2. The suggested land pattern dimensions have been provided as a straight lead reference only. A more robust pattern may be desired for wave soldering and/or bent lead configurations.

# Mouser Electronics

Authorized Distributor

Click to View Pricing, Inventory, Delivery & Lifecycle Information:

[InterFET:](#)

[VCR7N](#)