

Applications

- High frequency DC-DC converters

Benefits

- Low Gate-to-Drain Charge to Reduce Switching Losses
- Fully Characterized Capacitance Including Effective C_{OSS} to Simplify Design, (See App. Note AN1001)
- Fully Characterized Avalanche Voltage and Current

V_{DSS}	$R_{DS(on)}$ max	I_D
150V	0.045Ω	41A

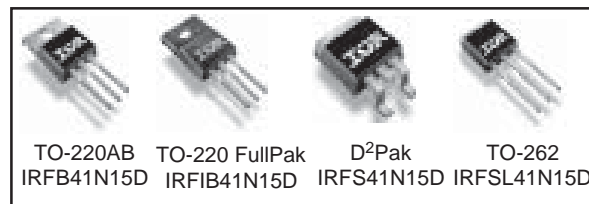

Absolute Maximum Ratings

	Parameter	Max.	Units
I_D @ $T_C = 25^\circ\text{C}$	Continuous Drain Current, V_{GS} @ 10V	41	A
I_D @ $T_C = 100^\circ\text{C}$	Continuous Drain Current, V_{GS} @ 10V	29	
I_{DM}	Pulsed Drain Current ①	164	
P_D @ $T_A = 25^\circ\text{C}$	Power Dissipation, D ² Pak	3.1	W
P_D @ $T_C = 25^\circ\text{C}$	Power Dissipation, TO-220	200	
P_D @ $T_C = 25^\circ\text{C}$	Power Dissipation, Fullpak	48	
	Linear Derating Factor, TO-220	1.3	W/ $^\circ\text{C}$
	Linear Derating Factor, Fullpak	0.32	
V_{GS}	Gate-to-Source Voltage	± 30	V
dv/dt	Peak Diode Recovery dv/dt ③	2.7	V/ns
T_J	Operating Junction and	-55 to + 175	$^\circ\text{C}$
T_{STG}	Storage Temperature Range		
	Soldering Temperature, for 10 seconds	300 (1.6mm from case)	
	Mounting torque, 6-32 or M3 screw	1.1(10)	N•m (lbf•in)

Thermal Resistance

	Parameter	Typ.	Max.	Units
$R_{\theta JC}$	Junction-to-Case	—	0.75	$^\circ\text{C/W}$
$R_{\theta JC}$	Junction-to-Case, Fullpak	—	3.14	
$R_{\theta CS}$	Case-to-Sink, Flat, Greased Surface ④	0.50	—	
$R_{\theta JA}$	Junction-to-Ambient, TO-220 ⑥	—	62	
$R_{\theta JA}$	Junction-to-Ambient, D ² Pak ⑦	—	40	
$R_{\theta JA}$	Junction-to-Ambient, Fullpak	—	65	

Notes ① through ⑦ are on page 12

www.irf.com

IRFB/IRFIB/IRFS/IRFSL41N15D

International
IR Rectifier

Static @ T_J = 25°C (unless otherwise specified)

	Parameter	Min.	Typ.	Max.	Units	Conditions
V _{(BR)DSS}	Drain-to-Source Breakdown Voltage	150	—	—	V	V _{GS} = 0V, I _D = 250μA
ΔV _{(BR)DSS/ΔT_J}	Breakdown Voltage Temp. Coefficient	—	0.17	—	V/°C	Reference to 25°C, I _D = 1mA
R _{DS(on)}	Static Drain-to-Source On-Resistance	—	—	0.045	Ω	V _{GS} = 10V, I _D = 25A ④
V _{GS(th)}	Gate Threshold Voltage	3.0	—	5.5	V	V _{DS} = V _{GS} , I _D = 250μA
I _{DSS}	Drain-to-Source Leakage Current	—	—	25	μA	V _{DS} = 150V, V _{GS} = 0V
		—	—	250		V _{DS} = 120V, V _{GS} = 0V, T _J = 150°C
I _{GSS}	Gate-to-Source Forward Leakage	—	—	100	nA	V _{GS} = 30V
	Gate-to-Source Reverse Leakage	—	—	-100		V _{GS} = -30V

Dynamic @ T_J = 25°C (unless otherwise specified)

	Parameter	Min.	Typ.	Max.	Units	Conditions
g _{fs}	Forward Transconductance	18	—	—	S	V _{DS} = 50V, I _D = 25A
Q _g	Total Gate Charge	—	72	110	nC	I _D = 25A V _{DS} = 120V V _{GS} = 10V ④
Q _{gs}	Gate-to-Source Charge	—	21	31		
Q _{gd}	Gate-to-Drain ("Miller") Charge	—	35	52		
t _{d(on)}	Turn-On Delay Time	—	16	—	ns	V _{DD} = 75V I _D = 25A R _G = 2.5Ω V _{GS} = 10V ④
t _r	Rise Time	—	63	—		
t _{d(off)}	Turn-Off Delay Time	—	25	—		
t _f	Fall Time	—	14	—		
C _{iss}	Input Capacitance	—	2520	—	pF	V _{GS} = 0V V _{DS} = 25V f = 1.0MHz V _{GS} = 0V, V _{DS} = 1.0V, f = 1.0MHz V _{GS} = 0V, V _{DS} = 120V, f = 1.0MHz V _{GS} = 0V, V _{DS} = 0V to 120V ⑤
C _{oss}	Output Capacitance	—	510	—		
C _{rss}	Reverse Transfer Capacitance	—	110	—		
C _{oss}	Output Capacitance	—	3090	—		
C _{oss}	Output Capacitance	—	230	—		
C _{oss eff.}	Effective Output Capacitance	—	250	—		

Avalanche Characteristics

	Parameter	Typ.	Max.	Units
E _{AS}	Single Pulse Avalanche Energy ②	—	470	mJ
I _{AR}	Avalanche Current ①	—	25	A
E _{AR}	Repetitive Avalanche Energy ①	—	20	mJ

Diode Characteristics

	Parameter	Min.	Typ.	Max.	Units	Conditions
I _S	Continuous Source Current (Body Diode)	—	—	41	A	MOSFET symbol showing the integral reverse p-n junction diode.
I _{SM}	Pulsed Source Current (Body Diode) ①	—	—	164		
V _{SD}	Diode Forward Voltage	—	—	1.3	V	T _J = 25°C, I _S = 25A, V _{GS} = 0V ④
t _{rr}	Reverse Recovery Time	—	170	260	ns	T _J = 25°C, I _F = 25A
Q _{rr}	Reverse Recovery Charge	—	1.3	1.9	μC	di/dt = 100A/μs ④
t _{on}	Forward Turn-On Time	Intrinsic turn-on time is negligible (turn-on is dominated by LS+LD)				

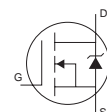

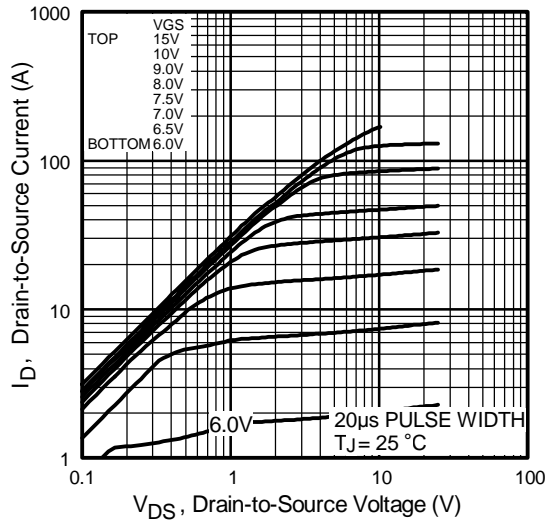

Fig 1. Typical Output Characteristics

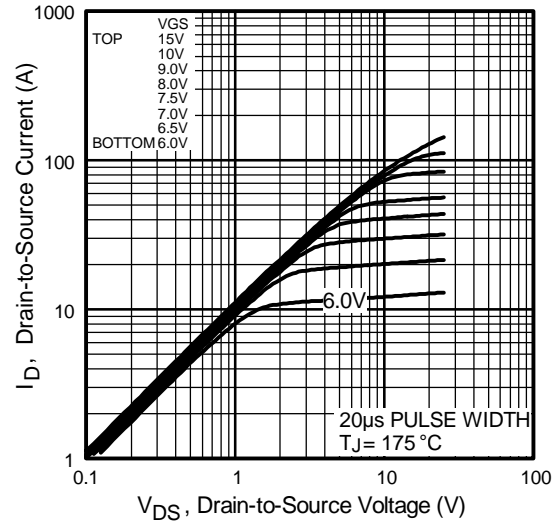

Fig 2. Typical Output Characteristics

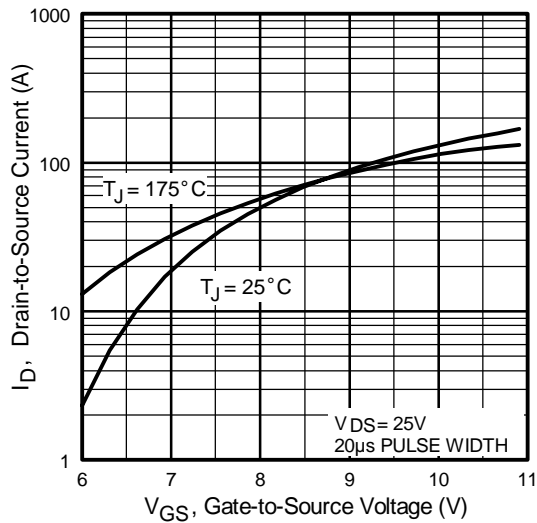

Fig 3. Typical Transfer Characteristics

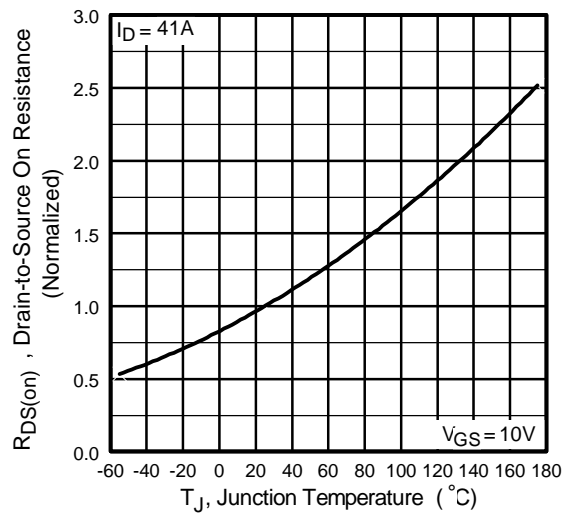

Fig 4. Normalized On-Resistance vs. Temperature

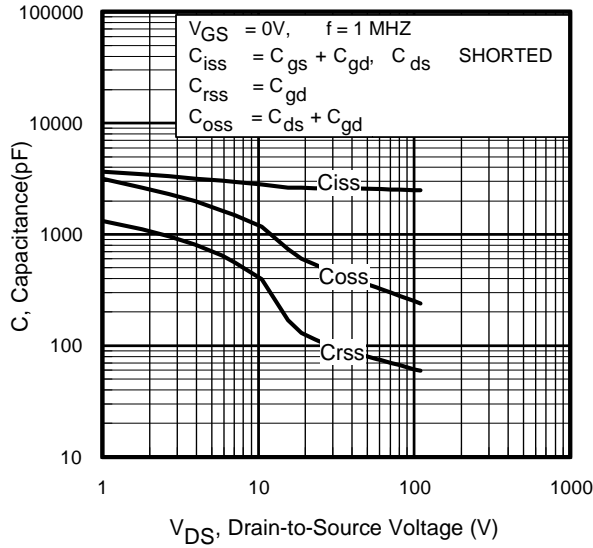

Fig 5. Typical Capacitance Vs. Drain-to-Source Voltage

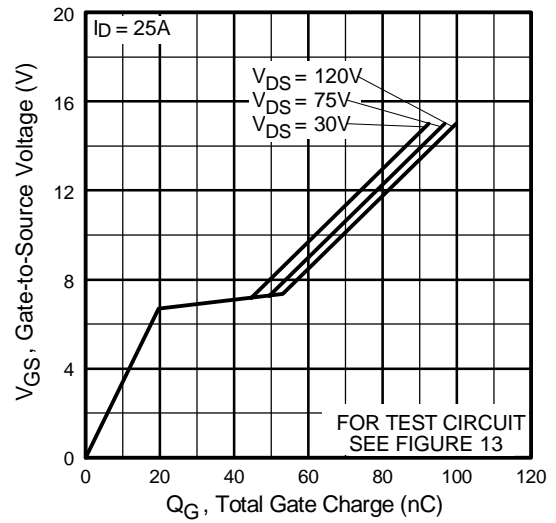

Fig 6. Typical Gate Charge Vs. Gate-to-Source Voltage

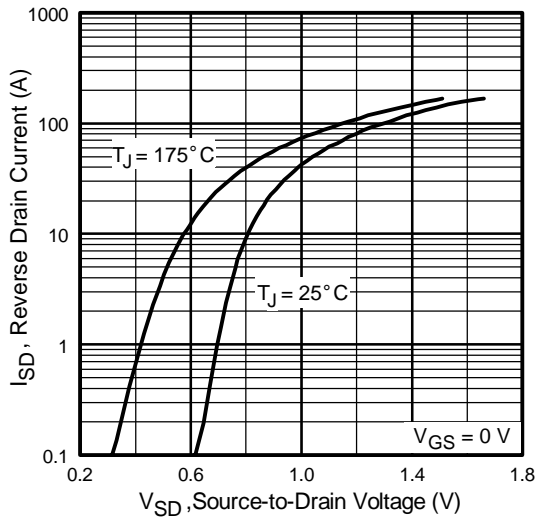

Fig 7. Typical Source-Drain Diode Forward Voltage

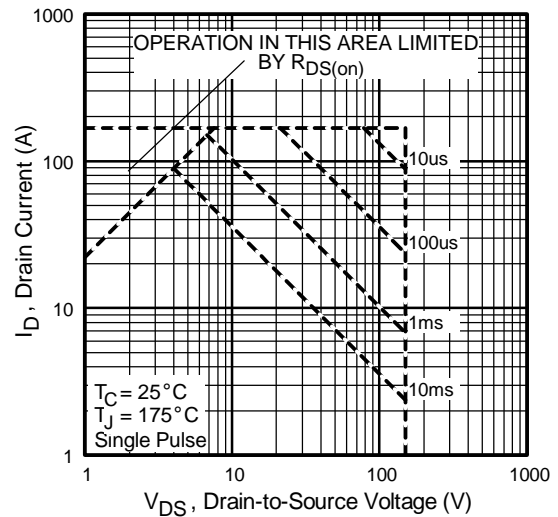

Fig 8. Maximum Safe Operating Area

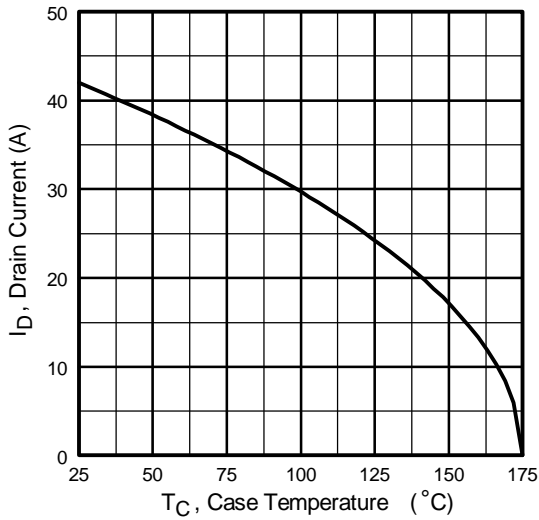

Fig 9. Maximum Drain Current Vs. Case Temperature

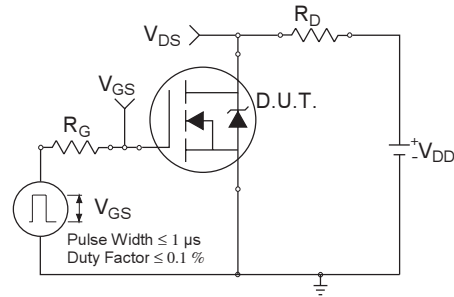

Fig 10a. Switching Time Test Circuit

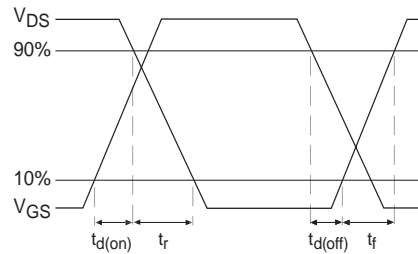

Fig 10b. Switching Time Waveforms

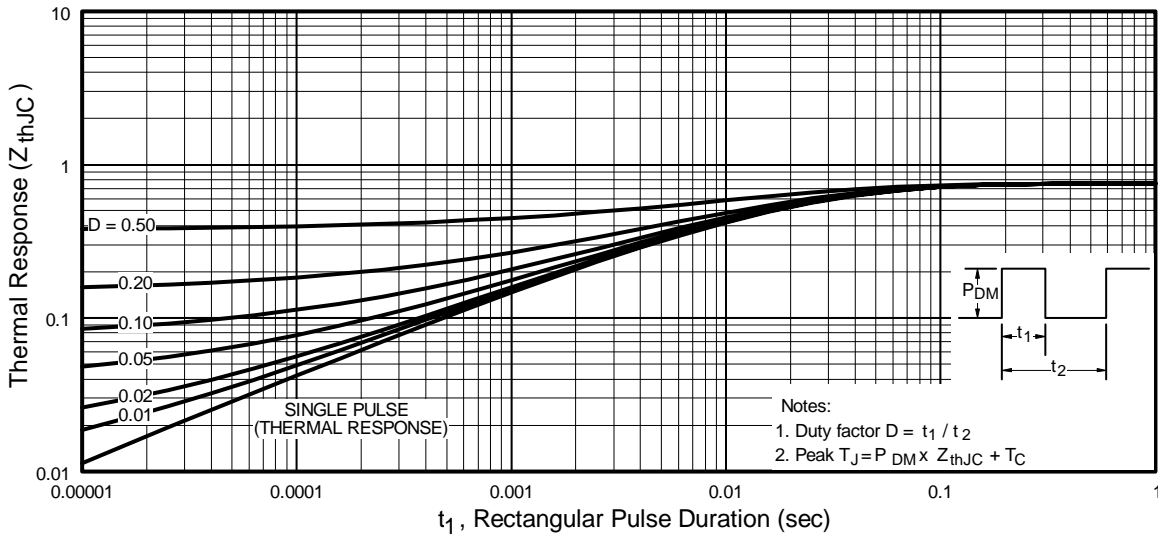

Fig 11. Maximum Effective Transient Thermal Impedance, Junction-to-Case

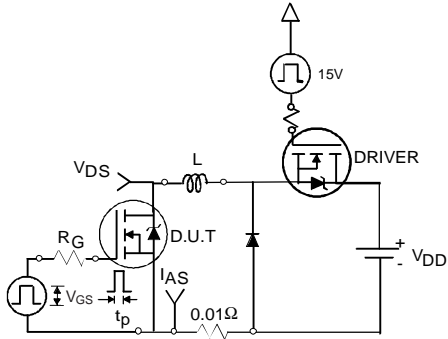

Fig 12a. Unclamped Inductive Test Circuit

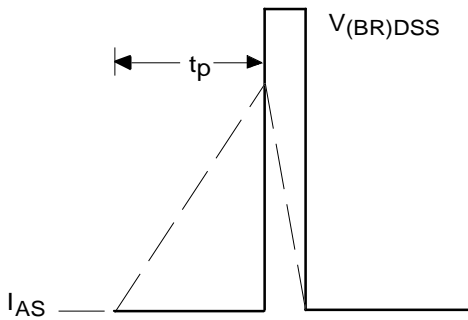

Fig 12b. Unclamped Inductive Waveforms

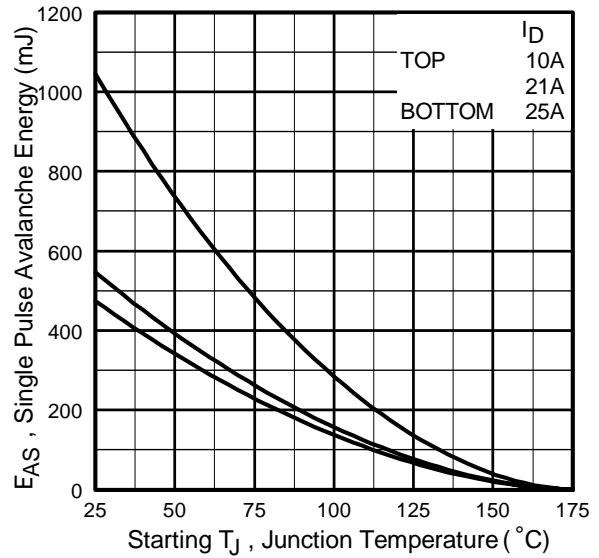

Fig 12c. Maximum Avalanche Energy Vs. Drain Current

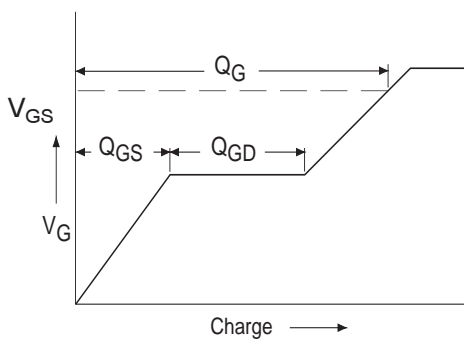

Fig 13a. Basic Gate Charge Waveform

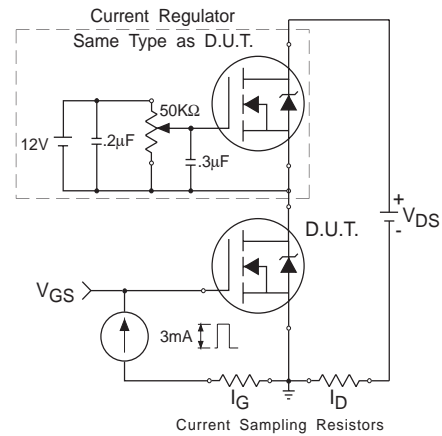
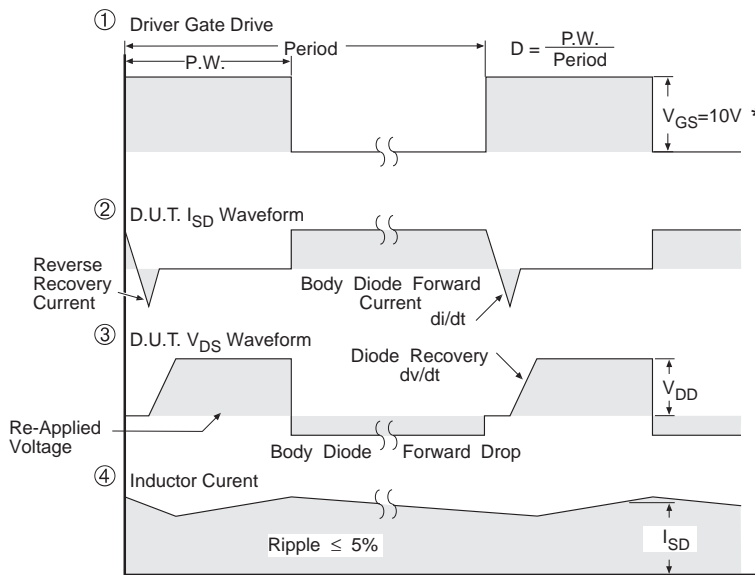
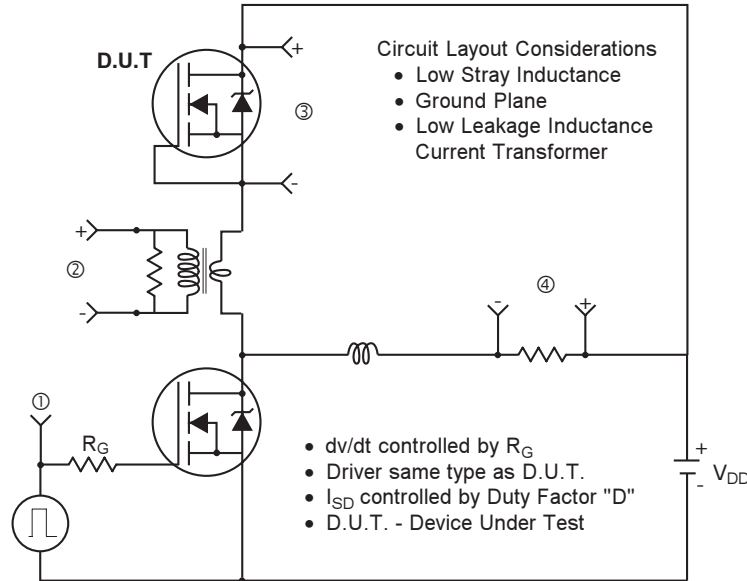

Fig 13b. Gate Charge Test Circuit

Peak Diode Recovery dv/dt Test Circuit



* $V_{GS} = 5V$ for Logic Level Devices

Fig 14. For N-Channel HEXFET® Power MOSFETs

TO-220 Full-Pak Package Outline

Dimensions are shown in millimeters (inches)

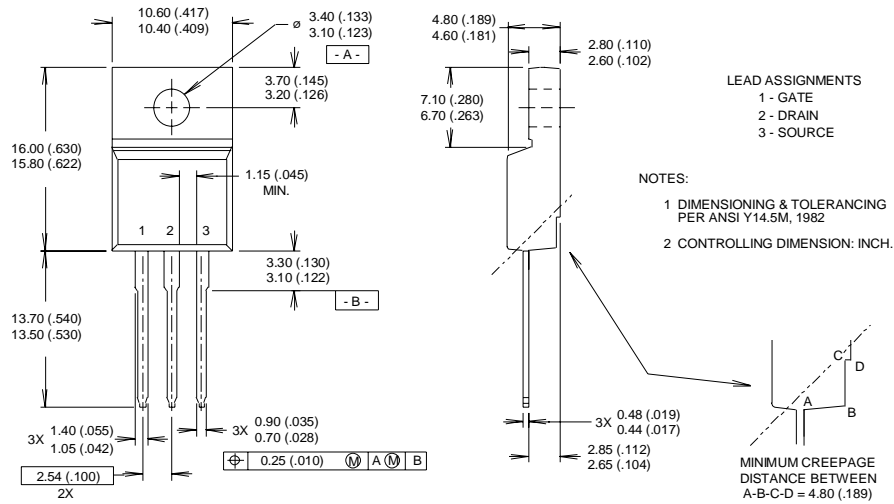

TO-220 Full-Pak Part Marking Information

Notes: This part marking information applies to all devices produced before 02/26/2001 and currently for parts manufactured in GB.

EXAMPLE: THIS IS AN IRF1840G
 WITH ASSEMBLY
 LOT CODE E401

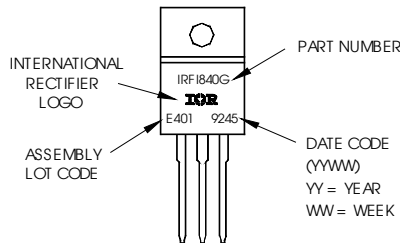

Notes: This part marking information applies to devices produced after 02/26/2001 in location other than GB.

EXAMPLE: THIS IS AN IRF1840G
 WITH ASSEMBLY
 LOT CODE 3432
 ASSEMBLED ON WW 24 1999
 IN THE ASSEMBLY LINE "K"

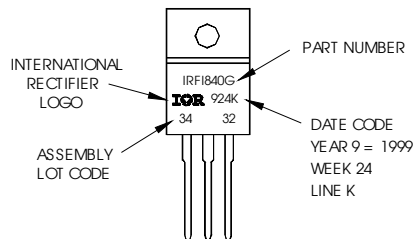

IRFB/IRFIB/IRFS/IRFSL41N15D

International
IR Rectifier

D²Pak Package Outline

Dimensions are shown in millimeters (inches)

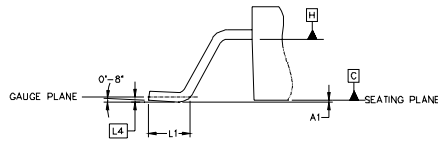

DETAIL "A"
ROTATED 90°
SCALE R:1

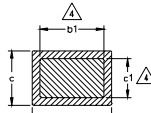

SECTION B-B
SCALE: NONE

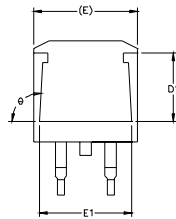

SECTION A-A

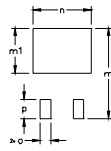

FOOT PRINT
SCALE 2:1

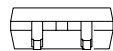
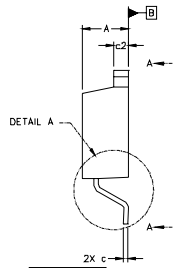
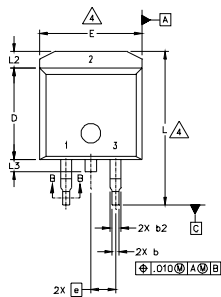

SYMBOL	DIMENSIONS				NOTES
	MILLIMETERS		INCHES		
	MIN.	MAX.	MIN.	MAX.	
A	4.06	4.83	.160	.190	4
A1		0.127		.005	
b	0.51	0.99	.020	.039	
b1	0.51	0.89	.020	.035	
b2	1.14	1.40	.045	.055	4
c	0.43	0.63	.017	.025	
c1	0.38	0.74	.015	.029	
c2	1.14	1.40	.045	.055	3
D	8.51	9.65	.335	.380	
D1	5.33		.210		
E	9.65	10.67	.380	.420	3
E1	6.22		.245		
e	2.54 BSC		.100 BSC		
L	14.61	15.88	.575	.625	
L1	1.78	2.79	.070	.110	
L2			1.65	.065	
L3	1.27	1.78	.050	.070	
L4	0.25 BSC		.010 BSC		
m	17.78		.700		
m1	8.89		.350		
n	11.43		.450		
o	2.08		.082		
p	3.81		.150		
θ	90°	93°	90°	93°	

LEAD ASSIGNMENTS

HEXFET	IGBTs, CoPACK	DIODES
1.- GATE	1.- GATE	1.- ANODE *
2.- DRAIN	2.- COLLECTOR	2.- CATHODE
3.- SOURCE	3.- EMITTER	3.- ANODE

* PART DEPENDENT.

NOTES:

1. DIMENSIONING AND TOLERANCING PER ASME Y14.5M-1994
2. DIMENSIONS ARE SHOWN IN MILLIMETERS [INCHES].
3. DIMENSION D & E DO NOT INCLUDE MOLD FLASH. MOLD FLASH SHALL NOT EXCEED 0.127 [.005"] PER SIDE. THESE DIMENSIONS ARE MEASURED AT THE OUTMOST EXTREMES OF THE PLASTIC BODY.
4. DIMENSION b1 AND c1 APPLY TO BASE METAL ONLY.
5. CONTROLLING DIMENSION: INCH.

D²Pak Part Marking Information

EXAMPLE: THIS IS AN IRF530S WITH
LOT CODE 8024
ASSEMBLED ON WW02, 2000
IN THE ASSEMBLY LINE "L"

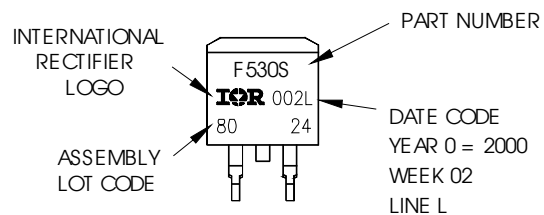

IRFB/IRFIB/IRFS/IRFSL41N15D

TO-262 Package Outline

Dimensions are shown in millimeters (inches)

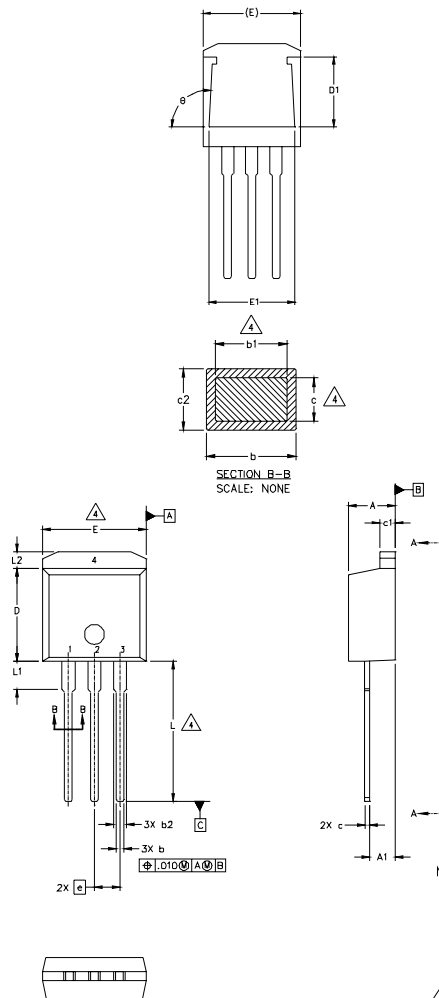

SYMBOL	DIMENSIONS				NOTES
	MILLIMETERS		INCHES		
	MIN.	MAX.	MIN.	MAX.	
A	4.06	4.83	.160	.190	4
A1	2.03	2.92	.080	.115	
b	0.51	0.99	.020	.039	
b1	0.51	0.89	.020	.035	
b2	1.14	1.40	.045	.055	4
c	0.38	0.63	.015	.025	
c1	1.14	1.40	.045	.055	3
c2	0.43	.063	.017	.029	
D	8.51	9.65	.335	.380	3
D1	5.33		.210		
E	9.65	10.67	.380	.420	3
E1	6.22		.245		
e	2.54 BSC		.100 BSC		
L	13.46	14.09	.530	.555	
L1	3.56	3.71	.140	.146	
L2		1.65		.065	

LEAD ASSIGNMENTS

HEXFET

- 1.- GATE
- 2.- DRAIN
- 3.- SOURCE
- 4.- DRAIN

IGBT

- 1- GATE
- 2- COLLECTOR
- 3- EMITTER

NOTES:

1. DIMENSIONING AND TOLERANCING PER ASME Y14.5M-1994
2. DIMENSIONS ARE SHOWN IN MILLIMETERS [INCHES].
3. DIMENSION D & E DO NOT INCLUDE MOLD FLASH. MOLD FLASH SHALL NOT EXCEED 0.127 [.005"] PER SIDE. THESE DIMENSIONS ARE MEASURED AT THE OUTMOST EXTREMES OF THE PLASTIC BODY.
4. DIMENSION b1 AND c1 APPLY TO BASE METAL ONLY.
5. CONTROLLING DIMENSION: INCH.

TO-262 Part Marking Information

EXAMPLE: THIS IS AN IRL3103L
LOT CODE 1789
ASSEMBLED ON WW 19, 1997
IN THE ASSEMBLY LINE "C"

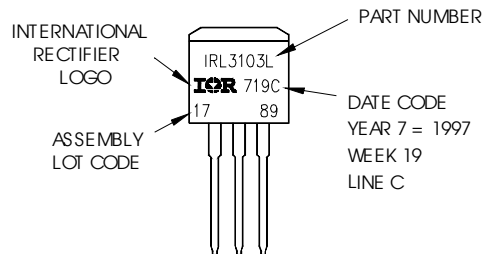

IRFB/IRFIB/IRFS/IRFSL41N15D

D²Pak Tape & Reel Information

International
IR Rectifier

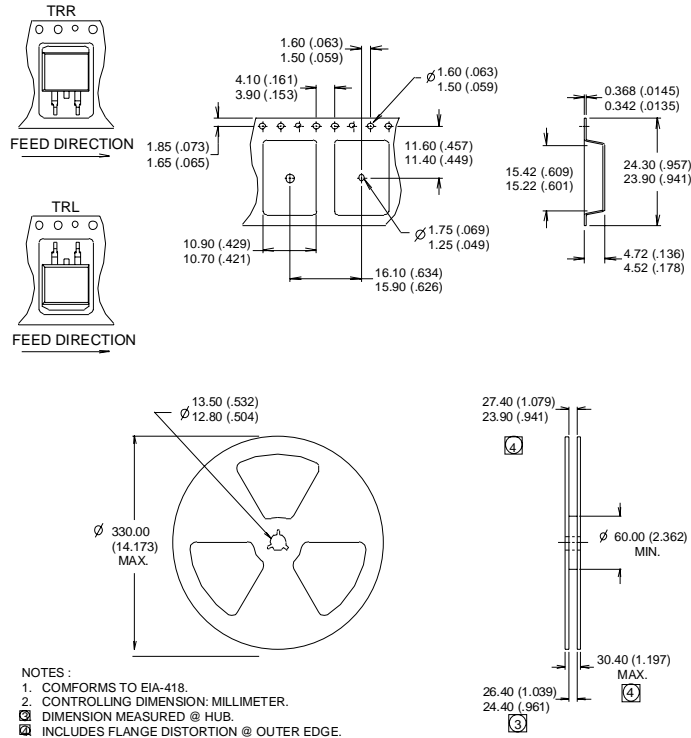

Notes:

- ① Repetitive rating; pulse width limited by max. junction temperature.
- ② Starting $T_J = 25^\circ\text{C}$, $L = 1.5\text{mH}$, $R_G = 25\Omega$, $I_{AS} = 25\text{A}$.
- ③ $I_{SD} \leq 25\text{A}$, $di/dt \leq 340\text{A}/\mu\text{s}$, $V_{DD} \leq V_{(BR)DSS}$, $T_J \leq 175^\circ\text{C}$.
- ④ Pulse width $\leq 300\mu\text{s}$; duty cycle $\leq 2\%$.
- ⑤ C_{OSS} eff. is a fixed capacitance that gives the same charging time as C_{OSS} while V_{DS} is rising from 0 to 80% V_{DSS}
- ⑥ This is only applied to TO-220AB package.
- ⑦ This is applied to D²Pak, when mounted on 1" square PCB (FR-4 or G-10 Material). For recommended footprint and soldering techniques refer to application note #AN-994.

TO-220AB & TO-220 FullPak packages are not recommended for Surface Mount Application.

Data and specifications subject to change without notice.
This product has been designed and qualified for the Industrial market.
Qualification Standards can be found on IR's Web site.

International
IR Rectifier

IR WORLD HEADQUARTERS: 233 Kansas St., El Segundo, California 90245, USA Tel: (310) 252-7105
TAC Fax: (310) 252-7903

Visit us at www.irf.com for sales contact information.07/03

www.irf.com