

3.5A, 200V, 0.800 Ohm, N-Channel Power MOSFET

This N-Channel enhancement mode silicon gate power field effect transistor is an advanced power MOSFET designed, tested, and guaranteed to withstand a specified level of energy in the breakdown avalanche mode of operation. All of these power MOSFETs are designed for applications such as switching regulators, switching convertors, motor drivers, relay drivers, and drivers for high power bipolar switching transistors requiring high speed and low gate drive power. These types can be operated directly from integrated circuits.

Formerly developmental type TA9600.

Ordering Information

| PART NUMBER | PACKAGE | BRAND |
|-------------|----------|---------|
| IRFF220 | TO-205AF | IRFF220 |

NOTE: When ordering, include the entire part number.

Features

- 3.5A, 200V
- $r_{DS(ON)} = 0.800\Omega$
- Single Pulse Avalanche Energy Rated
- SOA is Power Dissipation Limited
- Nanosecond Switching Speeds
- Linear Transfer Characteristics
- High Input Impedance
- Related Literature
 - TB334 "Guidelines for Soldering Surface Mount Components to PC Boards"

Symbol

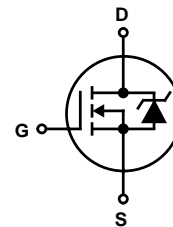

Packaging

JEDEC TO-205AF

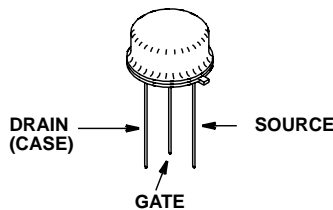

IRFF220

Absolute Maximum Ratings $T_C = 25^\circ\text{C}$, Unless Otherwise Specified

| | IRFF220 | UNITS |
|--|------------|---------------------|
| Drain to Source Voltage (Note 1) | 200 | V |
| Drain to Gate Voltage ($R_{GS} = 20\text{k}\Omega$) (Note 1) | 200 | V |
| Continuous Drain Current | 3.5 | A |
| Pulsed Drain Current (Note 3) | 14 | A |
| Gate to Source Voltage | ± 20 | V |
| Maximum Power Dissipation | 20 | W |
| Linear Derating Factor | 0.16 | W/ $^\circ\text{C}$ |
| Single Pulse Avalanche Energy Rating (Note 4) | 85 | mJ |
| Operating and Storage Temperature | -55 to 150 | $^\circ\text{C}$ |
| Maximum Temperature for Soldering | | |
| Leads at 0.063in (1.6mm) from Case for 10s | 300 | $^\circ\text{C}$ |
| Package Body for 10s, See Techbrief 334 | 260 | $^\circ\text{C}$ |

CAUTION: Stresses above those listed in "Absolute Maximum Ratings" may cause permanent damage to the device. This is a stress only rating and operation of the device at these or any other conditions above those indicated in the operational sections of this specification is not implied.

NOTE:

1. $T_J = 25^\circ\text{C}$ to 125°C .

Electrical Specifications $T_C = 25^\circ\text{C}$, Unless Otherwise Specified

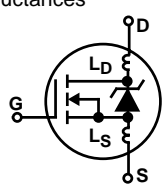
| PARAMETER | SYMBOL | TEST CONDITIONS | MIN | TYP | MAX | UNITS | | |
|---|-----------------|---|---|------|-----------|--------------------|---|----|
| Drain to Source Breakdown Voltage | BV_{DSS} | $V_{GS} = 0\text{V}$, $I_D = 250\mu\text{A}$ (Figure 10) | 200 | - | - | V | | |
| Gate to Threshold Voltage | $V_{GS(TH)}$ | $V_{GS} = V_{DS}$, $I_D = 250\mu\text{A}$ | 2.0 | - | 4.0 | V | | |
| Zero-Gate Voltage Drain Current | I_{DSS} | $V_{DS} = \text{Rated } BV_{DSS}$, $V_{GS} = 0\text{V}$ | - | - | 25 | μA | | |
| | | $V_{DS} = 0.8 \times \text{Rated } BV_{DSS}$, $V_{GS} = 0\text{V}$, $T_J = 125^\circ\text{C}$ | - | - | 250 | μA | | |
| On-State Drain Current (Note 2) | $I_{D(ON)}$ | $V_{DS} > I_{D(ON)} \times r_{DS(ON)MAX}$, $V_{GS} = 10\text{V}$ (Figure 7) | 3.5 | - | - | A | | |
| Gate to Source Leakage Forward | I_{GSS} | $V_{GS} = \pm 20\text{V}$ | - | - | ± 100 | nA | | |
| Drain to Source On Resistance (Note 2) | $r_{DS(ON)}$ | $V_{GS} = 10\text{V}$, $I_D = 2.0\text{A}$ (Figures 8, 9) | - | 0.5 | 0.800 | Ω | | |
| Forward Transconductance (Note 2) | g_{fs} | $V_{DS} > I_{D(ON)} \times r_{DS(ON)MAX}$, $I_D = 2.0\text{A}$ (Figure 12) | 1.5 | 2.25 | - | S | | |
| Turn-On Delay Time | $t_{d(ON)}$ | $V_{DD} = 0.5 \times \text{Rated } BV_{DSS}$, $R_G = 9.1\Omega$, $V_{GS} = 10\text{V}$, $I_D \approx 3.5\text{A}$ (Figures 17, 18) $R_L = 27.4\Omega$ for $V_{DSS} = 100\text{V}$, $R_L = 20.3\Omega$ for $V_{DSS} = 75\text{V}$, MOSFET Switching Times are Essentially Independent of Operating Temperature | - | 20 | 40 | ns | | |
| Rise Time | t_r | | - | 30 | 60 | ns | | |
| Turn-Off Delay Time | $t_{d(OFF)}$ | | - | 50 | 100 | ns | | |
| Fall Time | t_f | | - | 30 | 60 | ns | | |
| Total Gate Charge (Gate to Source + Gate to Drain) | $Q_{g(TOT)}$ | $V_{GS} = 10\text{V}$, $I_D = 3.5\text{A}$, $V_{DS} = 0.8 \times \text{Rated } BV_{DSS}$, $I_{g(REF)} = 1.5\text{mA}$ (Figures 14, 19, 20) Gate Charge is Essentially Independent of Operating Temperature | - | 11 | 15 | nC | | |
| Gate to Source Charge | Q_{gs} | | - | 5.0 | - | nC | | |
| Gate to Drain "Miller" Charge | Q_{gd} | | - | 6.0 | - | nC | | |
| Input Capacitance | C_{ISS} | $V_{GS} = 0\text{V}$, $V_{DS} = 25\text{V}$, $f = 1.0\text{MHz}$ (Figure 11) | - | 450 | - | pF | | |
| Output Capacitance | C_{OSS} | | - | 150 | - | pF | | |
| Reverse Transfer Capacitance | C_{RSS} | | - | 40 | - | pF | | |
| Internal Drain Inductance | L_D | Measured from the Drain Lead, 5mm (0.2in) from Header to Center of Die | Modified MOSFET Symbol Showing the Internal Device Inductances  | | - | 5.0 | - | nH |
| Internal Source Inductance | L_S | Measured from the Source Lead, 5mm (0.2in) from Header and Source Bonding Pad | | | - | 15 | - | nH |
| Junction to Case | $R_{\theta JC}$ | | - | - | 6.25 | $^\circ\text{C/W}$ | | |
| Junction to Ambient | $R_{\theta JA}$ | Free Air Operation | - | - | 175 | $^\circ\text{C/W}$ | | |

Source to Drain Diode Specifications

| PARAMETER | SYMBOL | TEST CONDITIONS | MIN | TYP | MAX | UNITS |
|--|-----------|---|-----|-----|-----|---------------|
| Continuous Source to Drain Current | I_{SD} | Modified MOSFET Symbol Showing the Integral Reverse P-N Junction Rectifier | - | - | 3.5 | A |
| Pulse Source to Drain Current (Note 3) | I_{SDM} | | - | - | 14 | A |
| Source to Drain Diode Voltage (Note 2) | V_{SD} | $T_J = 25^{\circ}\text{C}$, $I_{SD} = 3.5\text{A}$, $V_{GS} = 0\text{V}$ (Figure 13) | - | - | 2.0 | V |
| Reverse Recovery Time | t_{rr} | $T_J = 150^{\circ}\text{C}$, $I_{SD} = 3.5\text{A}$, $dI_{SD}/dt = 100\text{A}/\mu\text{s}$ | - | 350 | - | ns |
| Reverse Recovered Charge | Q_{RR} | $T_J = 150^{\circ}\text{C}$, $I_{SD} = 3.5\text{A}$, $dI_{SD}/dt = 100\text{A}/\mu\text{s}$ | - | 2.3 | - | μC |

NOTES:

2. Pulse test: pulse width $\leq 300\mu\text{s}$, duty cycle $\leq 2\%$.
3. Repetitive rating: pulse width limited by Max junction temperature. See Transient Thermal Impedance curve (Figure 3).
4. $V_{DD} = 20\text{V}$, start $T_J = 25^{\circ}\text{C}$, $L = 12.5\text{mH}$, $R_G = 50\Omega$, peak $I_{AS} = 3.5\text{A}$ (Figures 15, 16).

Typical Performance Curves

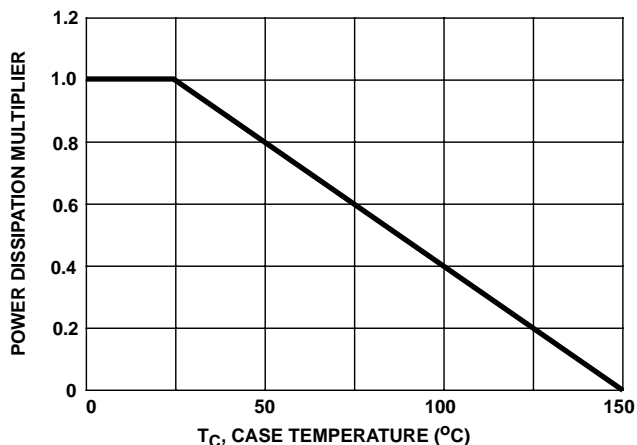

FIGURE 1. NORMALIZED POWER DISSIPATION vs CASE TEMPERATURE

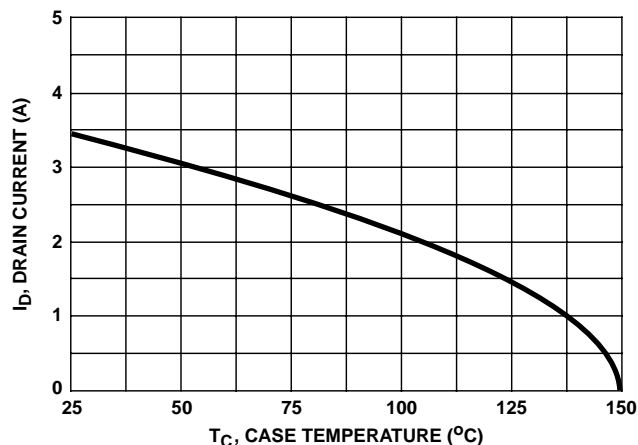

FIGURE 2. MAXIMUM CONTINUOUS DRAIN CURRENT vs CASE TEMPERATURE

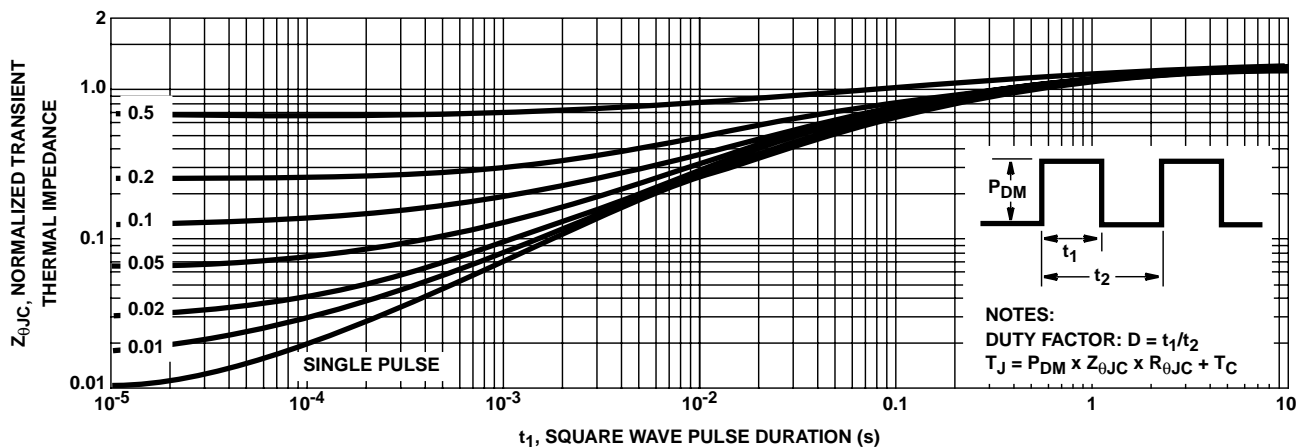

FIGURE 3. NORMALIZED MAXIMUM TRANSIENT THERMAL IMPEDANCE

Typical Performance Curves (Continued)

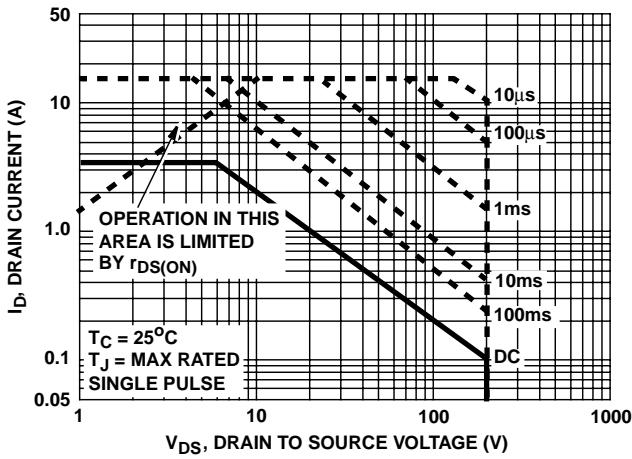

FIGURE 4. FORWARD BIAS SAFE OPERATING AREA

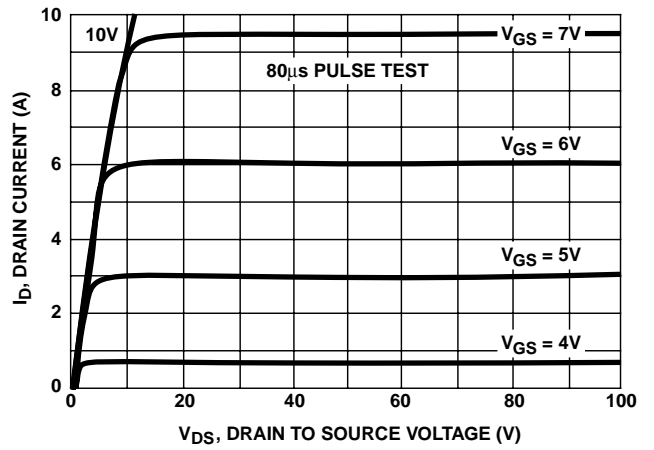

FIGURE 5. OUTPUT CHARACTERISTICS

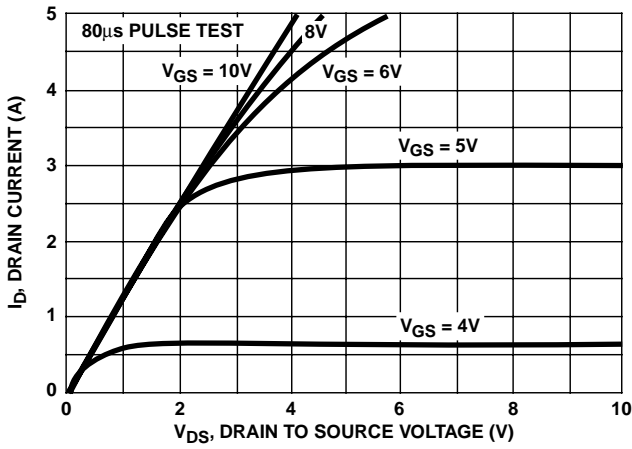

FIGURE 6. SATURATION CHARACTERISTICS

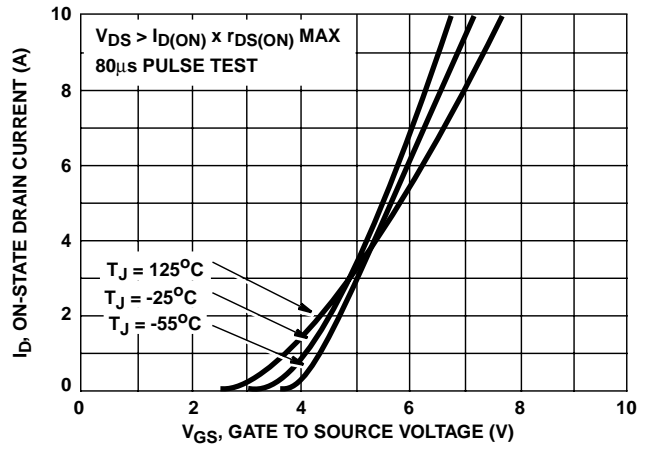
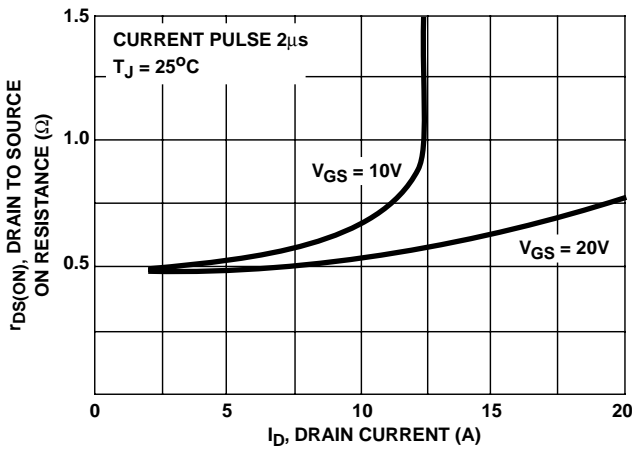

FIGURE 7. TRANSFER CHARACTERISTICS



NOTE: Heating effect of 2µs pulse is minimal.

FIGURE 8. DRAIN TO SOURCE ON RESISTANCE vs GATE VOLTAGE AND DRAIN CURRENT

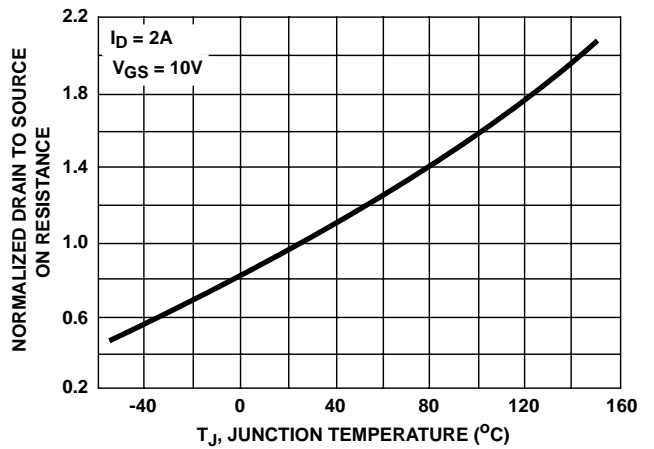

FIGURE 9. NORMALIZED DRAIN TO SOURCE ON RESISTANCE vs JUNCTION TEMPERATURE

Typical Performance Curves (Continued)

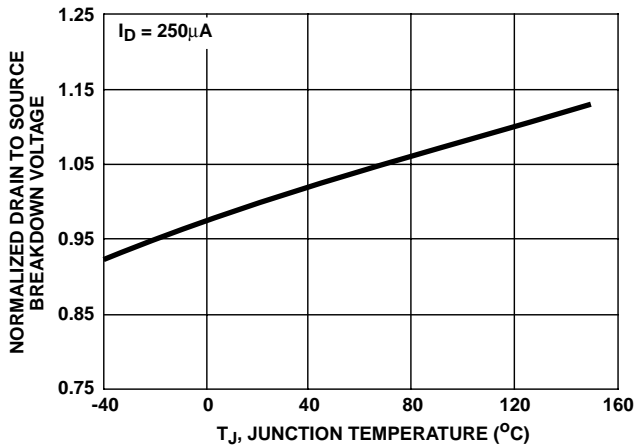

FIGURE 10. NORMALIZED DRAIN TO SOURCE BREAKDOWN VOLTAGE vs JUNCTION TEMPERATURE

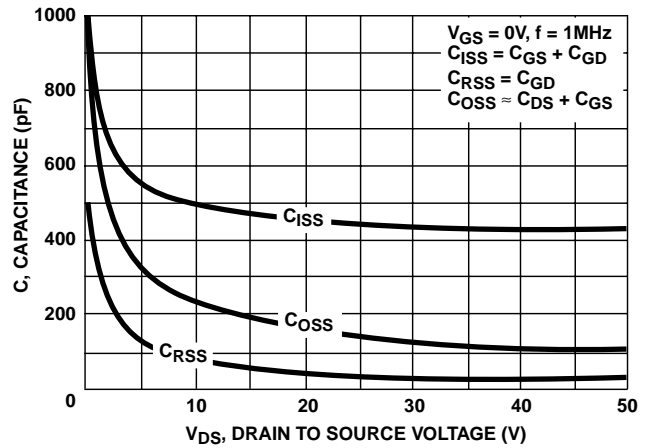

FIGURE 11. CAPACITANCE vs DRAIN TO SOURCE VOLTAGE

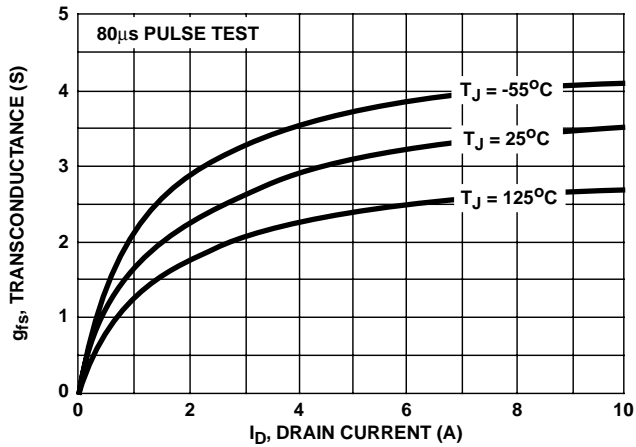

FIGURE 12. TRANSCONDUCTANCE vs DRAIN CURRENT

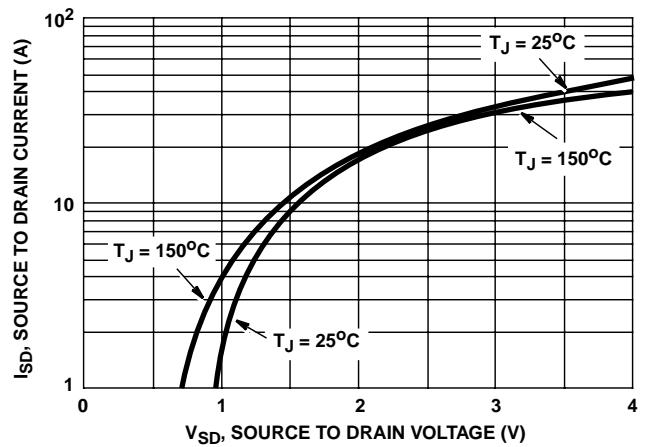

FIGURE 13. SOURCE TO DRAIN DIODE VOLTAGE

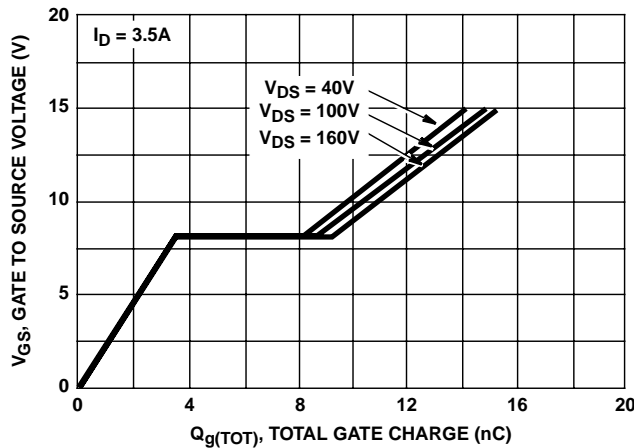

FIGURE 14. GATE TO SOURCE VOLTAGE vs GATE CHARGE

Test Circuits and Waveforms

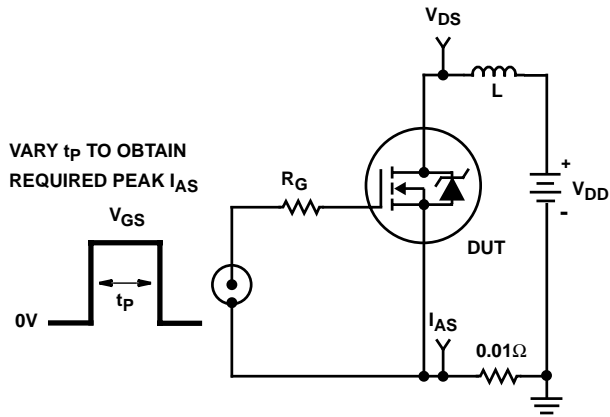

FIGURE 15. UNCLAMPED ENERGY TEST CIRCUIT

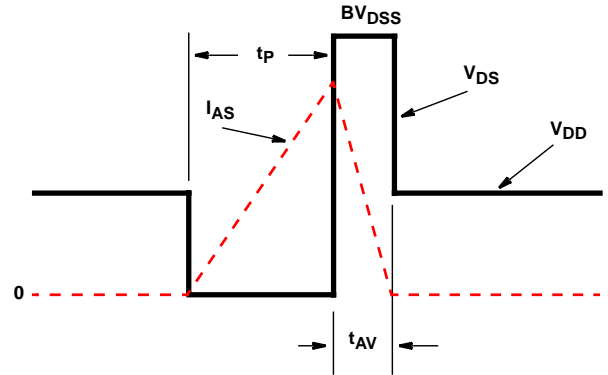

FIGURE 16. UNCLAMPED ENERGY WAVEFORMS

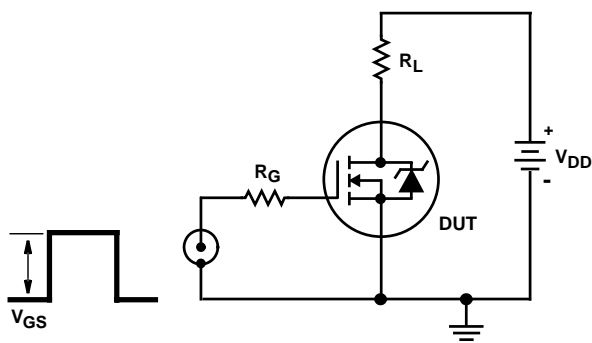

FIGURE 17. SWITCHING TIME TEST CIRCUIT

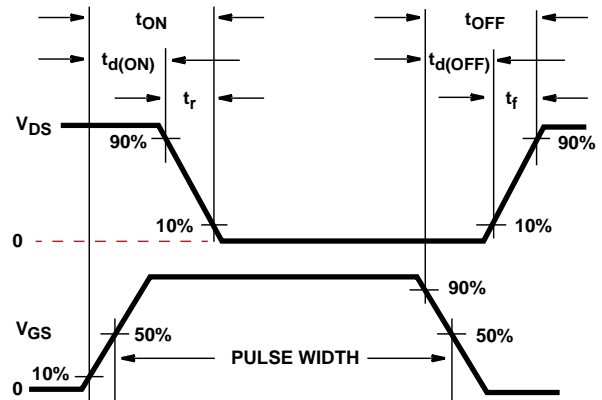

FIGURE 18. RESISTIVE SWITCHING WAVEFORMS

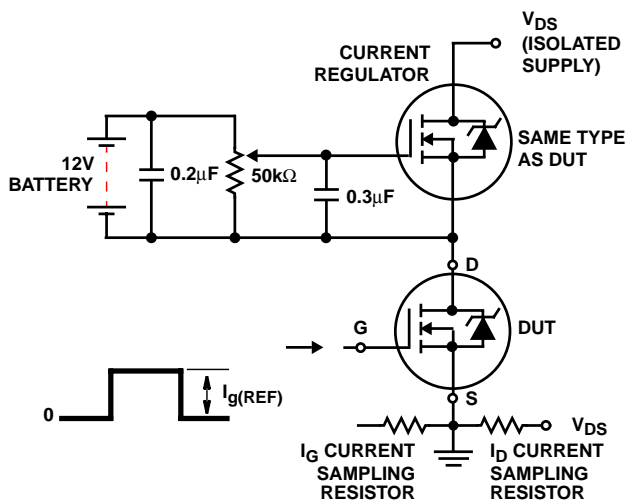

FIGURE 19. GATE CHARGE TEST CIRCUIT

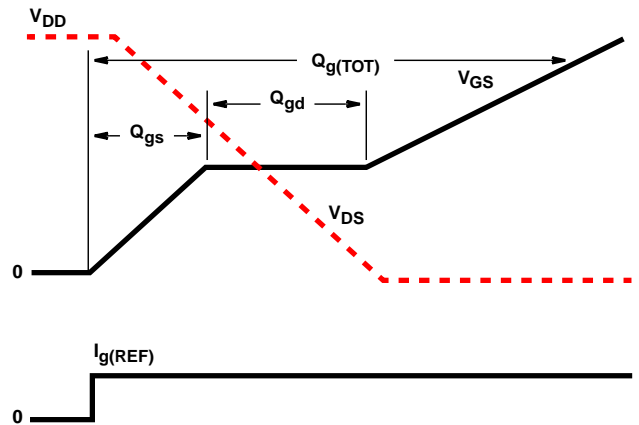

FIGURE 20. GATE CHARGE WAVEFORM

All Intersil semiconductor products are manufactured, assembled and tested under **ISO9000** quality systems certification.

Intersil semiconductor products are sold by description only. Intersil Corporation reserves the right to make changes in circuit design and/or specifications at any time without notice. Accordingly, the reader is cautioned to verify that data sheets are current before placing orders. Information furnished by Intersil is believed to be accurate and reliable. However, no responsibility is assumed by Intersil or its subsidiaries for its use; nor for any infringements of patents or other rights of third parties which may result from its use. No license is granted by implication or otherwise under any patent or patent rights of Intersil or its subsidiaries.

For information regarding Intersil Corporation and its products, see web site <http://www.intersil.com>

Sales Office Headquarters

NORTH AMERICA

Intersil Corporation
P. O. Box 883, Mail Stop 53-204
Melbourne, FL 32902
TEL: (407) 724-7000
FAX: (407) 724-7240

EUROPE

Intersil SA
Mercure Center
100, Rue de la Fusee
1130 Brussels, Belgium
TEL: (32) 2.724.2111
FAX: (32) 2.724.22.05

ASIA

Intersil (Taiwan) Ltd.
7F-6, No. 101 Fu Hsing North Road
Taipei, Taiwan
Republic of China
TEL: (886) 2 2716 9310
FAX: (886) 2 2715 3029