

**FAIRCHILD**  
A Schlumberger Company

**IRF240-243/IRF640-643 T-39-13**  
**N-Channel Power MOSFETs,**  
**18 A, 150-200 V**

Power And Discrete Division

**Description**

These devices are n-channel, enhancement mode, power MOSFETs designed especially for high power, high speed applications, such as switching power supplies, UPS, AC and DC motor controls, relay and solenoid drivers and high energy pulse circuits.

- Low  $R_{DS(on)}$
- $V_{GS}$  Rated at  $\pm 20$  V
- Silicon Gate for Fast Switching Speeds
- $I_{DSS}$ ,  $V_{DS(on)}$  Specified at Elevated Temperature
- Rugged
- Low Drive Requirements
- Ease of Paralleling

TO-204AE

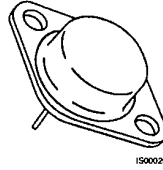

IRF240  
IRF241  
IRF242  
IRF243

TO-220AB

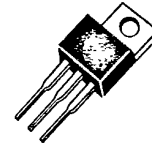

IRF640  
IRF641  
IRF642  
IRF643

**Product Summary**

Part Number	$V_{DSS}$	$R_{DS(on)}$	$I_D$ at $T_C = 25^\circ C$	$I_D$ at $T_C = 100^\circ C$	Case Style
IRF240	200 V	0.18 $\Omega$	18 A	11 A	TO-204AE
IRF241	150 V	0.18 $\Omega$	18 A	11 A	
IRF242	200 V	0.22 $\Omega$	16 A	10 A	
IRF243	150 V	0.22 $\Omega$	16 A	10 A	
IRF640	200 V	0.18 $\Omega$	18 A	11 A	TO-220AB
IRF641	150 V	0.18 $\Omega$	18 A	11 A	
IRF642	200 V	0.22 $\Omega$	16 A	10 A	
IRF643	150 V	0.22 $\Omega$	16 A	10 A	

**Notes**

For information concerning connection diagram and package outline, refer to Section 7.

## IRF240-243/IRF640-643

T-39-13

## Maximum Ratings

Symbol	Characteristic	Rating IRF240/242 IRF640/642	Rating IRF241/243 IRF641/643	Unit
V <sub>DSS</sub>	Drain to Source Voltage <sup>1</sup>	200	150	V
V <sub>DGR</sub>	Drain to Gate Voltage <sup>1</sup> R <sub>GS</sub> = 20 k $\Omega$	200	150	V
V <sub>GS</sub>	Gate to Source Voltage	$\pm 20$	$\pm 20$	V
T <sub>J</sub> , T <sub>stg</sub>	Operating Junction and Storage Temperatures	-55 to +150	-55 to +150	$^{\circ}\text{C}$
T <sub>L</sub>	Maximum Lead Temperature for Soldering Purposes, 1/8" From Case for 5 s	275	275	$^{\circ}\text{C}$

## Maximum Thermal Characteristics

		IRF240-243	IRF640-643	
R <sub><math>\theta</math>JC</sub>	Thermal Resistance, Junction to Case	1.0	1.0	$^{\circ}\text{C}/\text{W}$
P <sub>D</sub>	Total Power Dissipation at T <sub>C</sub> = 25 $^{\circ}\text{C}$	125	125	W
I <sub>DM</sub>	Pulsed Drain Current <sup>2</sup>	72	72	A

Electrical Characteristics (T<sub>C</sub> = 25 $^{\circ}\text{C}$  unless otherwise noted)

Symbol	Characteristic	Min	Max	Unit	Test Conditions
--------	----------------	-----	-----	------	-----------------

## Off Characteristics

V <sub>(BR)DSS</sub>	Drain Source Breakdown Voltage <sup>1</sup> IRF240/242/640/642 IRF241/243/641/643			V	V <sub>GS</sub> = 0 V, I <sub>D</sub> = 250 $\mu\text{A}$
		200			
		150			
I <sub>DSS</sub>	Zero Gate Voltage Drain Current		250	$\mu\text{A}$	V <sub>DS</sub> = Rated V <sub>DSS</sub> , V <sub>GS</sub> = 0 V
			1000	$\mu\text{A}$	V <sub>DS</sub> = 0.8 $\times$ Rated V <sub>DSS</sub> , V <sub>GS</sub> = 0 V, T <sub>C</sub> = 125 $^{\circ}\text{C}$
I <sub>GSS</sub>	Gate-Body Leakage Current IRF240-243 IRF640-643			nA	V <sub>GS</sub> = $\pm 20$ V, V <sub>DS</sub> = 0 V
			$\pm 100$		
			$\pm 500$		

## On Characteristics

V <sub>GS(th)</sub>	Gate Threshold Voltage	2.0	4.0	V	I <sub>D</sub> = 250 $\mu\text{A}$ , V <sub>DS</sub> = V <sub>GS</sub>
R <sub>DS(on)</sub>	Static Drain-Source On-Resistance <sup>2</sup> IRF240/241/640/641 IRF242/243/642/643			$\Omega$	V <sub>GS</sub> = 10 V, I <sub>D</sub> = 10 A
			0.18		
			0.22		
g <sub>fs</sub>	Forward Transconductance	6.0		S ( $\Omega$ )	V <sub>DS</sub> = 10 V, I <sub>D</sub> = 10 A

## IRF240-243/IRF640-643

T-39-13

Electrical Characteristics (Cont.) ( $T_C = 25^\circ\text{C}$  unless otherwise noted)

Symbol	Characteristic	Min	Max	Unit	Test Conditions
<b>Dynamic Characteristics</b>					
$C_{iss}$	Input Capacitance		1600	pF	$V_{DS} = 25\text{ V}$ , $V_{GS} = 0\text{ V}$ $f = 1.0\text{ MHz}$
$C_{oss}$	Output Capacitance		750	pF	
$C_{rss}$	Reverse Transfer Capacitance		300	pF	

Switching Characteristics ( $T_C = 25^\circ\text{C}$ , Figures 1, 2)<sup>3</sup>

$t_{d(on)}$	Turn-On Delay Time		30	ns	$V_{DD} = 75\text{ V}$ , $I_D = 10\text{ A}$ $V_{GS} = 10\text{ V}$ , $R_{GEN} = 4.7\ \Omega$ $R_{GS} = 4.7\ \Omega$
$t_r$	Rise Time		60	ns	
$t_{d(off)}$	Turn-Off Delay Time		80	ns	
$t_f$	Fall Time		60	ns	
$t_{d(on)}$	Turn-On Delay Time		60	ns	$V_{DD} = 25\text{ V}$ , $I_D = 10\text{ A}$ $V_{GS} = 10\text{ V}$ , $R_{GEN} = 50\ \Omega$ $R_{GS} = 50\ \Omega$
$t_r$	Rise Time		300	ns	
$t_{d(off)}$	Turn-Off Delay Time		200	ns	
$t_f$	Fall Time		150	ns	
$Q_g$	Total Gate Charge		60	nC	$V_{GS} = 10\text{ V}$ , $I_D = 22\text{ A}$ $V_{DD} = 120\text{ V}$

Symbol	Characteristic	Typ	Max	Unit	Test Conditions
<b>Source-Drain Diode Characteristics</b>					
$V_{SD}$	Diode Forward Voltage				
	IRF240/241/640/641	1.7	2.0	V	$I_S = 18\text{ A}$ ; $V_{GS} = 0\text{ V}$
	IRF242/243/642/643	1.7	1.9	V	$I_S = 16\text{ A}$ ; $V_{GS} = 0\text{ V}$
$t_{rr}$	Reverse Recovery Time	400		ns	$I_S = 4\text{ A}$ ; $di_S/dt = 25\text{ A}/\mu\text{S}$

## Notes

- $T_J = +25^\circ\text{C}$  to  $+150^\circ\text{C}$
- Pulse width limited by maximum  $T_J$ .
- Switching time measurements performed on LEM TR-58 test equipment.

IRF240-243/IRF640-643

T-39-13

Typical Electrical Characteristics

Figure 1 Switching Test Circuit

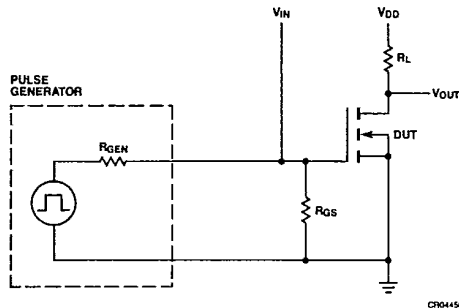
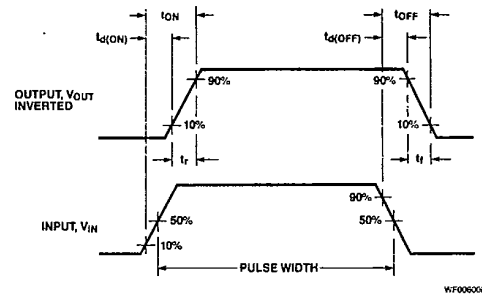

Figure 2 Switching Waveforms



Typical Performance Curves

Figure 3 Output Characteristics

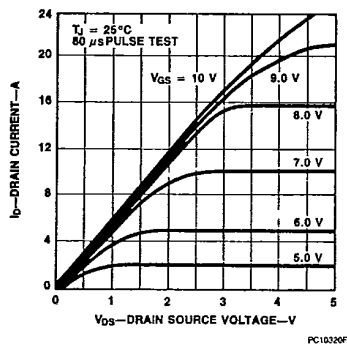

Figure 4 Static Drain to Source Resistance vs Drain Current

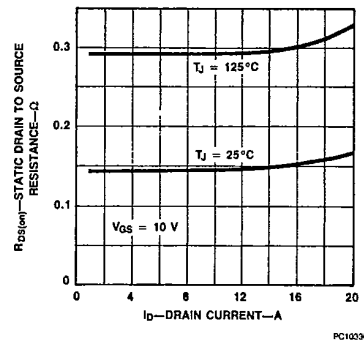

Figure 5 Transfer Characteristics

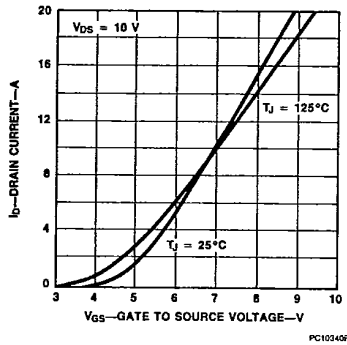
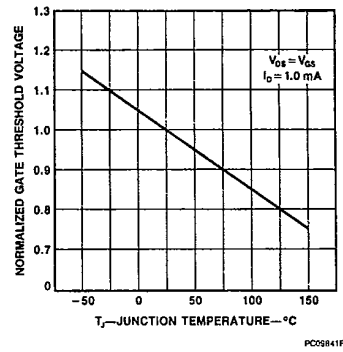

Figure 6 Temperature Variation of Gate to Source Threshold Voltage



IRF240-243/IRF640-643

T-39-13

Typical Performance Curves (Cont.)

Figure 7 Capacitance vs Drain to Source Voltage

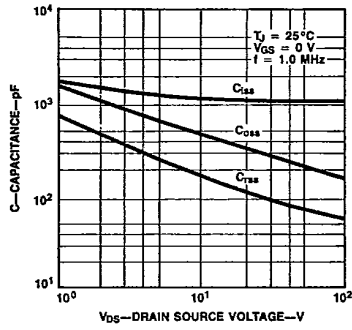

Figure 8 Gate to Source Voltage vs Total Gate Charge

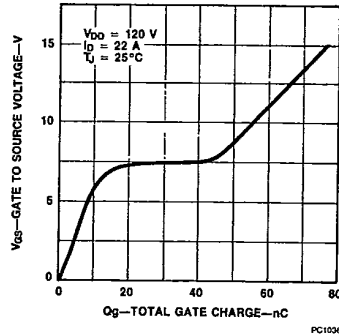

Figure 9 Forward Biased Safe Operating Area

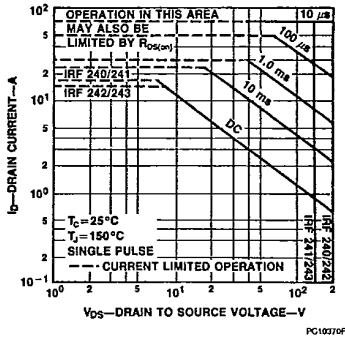

Figure 10 Transient Thermal Resistance vs Time

